



Electrical & Mechanical Services Department

Government of the Hong Kong Special
Administrative Region

Agreement No. : CE 36/2000
**Study on the Potential Applications of
Renewable Energy in Hong Kong**

Stage 1 Study Report

December 2002



Prepared by
Camp Dresser & McKee International Inc.
in association with
GHK (HK) Ltd.

TABLE OF CONTENTS

PART A - INTRODUCTION

1 INTRODUCTION	1-1
1.1 Background.....	1-1
1.2 Policy Context	1-1
1.3 Study Objectives	1-2
2 STAGE 1 STUDY OBJECTIVE, SCOPE AND REPORT STRUCTURE.....	2-1
2.1 Objective and Scope	2-1
2.2 Structure of Report	2-1

PART B - TECHNOLOGIES REVIEW

3 APPROACH TO TECHNOLOGIES REVIEW	3-1
3.1 Overview.....	3-1
3.2 Resource Definition.....	3-1
3.3 Approach.....	3-2
4 OUTLINE OF KEY LOCAL CHARACTERISTICS	4-1
4.1 Energy Consumption Patterns.....	4-1
4.2 Key Local Characteristics	4-6
5 SOLAR ENERGY.....	5-1
5.1 Overview.....	5-1
5.2 Photovoltaic (PV).....	5-1
5.3 Solar Thermal Power (Electricity Generating) Technology	5-6
5.4 Solar Water Heating.....	5-10
5.5 Solar Technology for Wide Scale Application.....	5-15
5.6 Identification of PV Deployment Options.....	5-15
5.7 PV Resource Estimation	5-16
5.8 Review of Environmental Issues.....	5-19
5.9 Preliminary Estimates of Generation Cost.....	5-19
5.10 Implementation Issues.....	5-19
5.11 Conclusions.....	5-20
6 WIND ENERGY.....	6-1
6.1 Wind Energy Basic	6-1
6.2 Wind Turbine Technology	6-1
6.3 Options for Wide-Scale Deployment	6-7
6.4 Resource Assessment.....	6-9
6.5 Review of Environmental, Safety And Social Issues.....	6-14
6.6 Estimates of Generation Costs.....	6-17
6.7 Implementation Issues.....	6-17
6.8 Conclusions.....	6-18
7 FUEL CELLS.....	7-1
7.1 Types of Fuel Cells	7-1
7.2 Status of The Technologies.....	7-5

7.3	Resource Assessment.....	7-8
7.4	Fuel Cell Deployment Option in Hong Kong.....	7-11
7.5	Fuel Cell for Wide-Scale Applications	7-19
7.6	Review of Environmental Issues.....	7-21
7.7	Estimate of Generation Cost	7-21
7.8	Implementation Issues.....	7-21
7.9	Conclusions.....	7-21
8	ENERGY-FROM-WASTE.....	8-1
8.1	Technology Identification	8-1
8.2	Combustion with Energy Recovery	8-1
8.3	Gasification	8-3
8.4	Landfill Gas Utilisation.....	8-5
8.5	Anaerobic Digestion of MSW	8-7
8.6	Resource Assessment.....	8-8
8.7	Recommendations	8-15
9	REVIEW OF OTHER RESOURCES/TECHNOLOGIES	9-1
9.1	Overview	9-1
9.2	Biomass Energy.....	9-1
9.3	Small-Scale Hydroelectric	9-6
9.4	Tidal and Wave Power	9-16
9.5	Geothermal Energy	9-26
9.6	Independent Energy Storage Systems	9-35
10	CATEGORISATION OF RENEWABLE ENERGY OPTIONS	10-1
PART C - ISSUES AND BARRIERS		
11	THE OPERATING ENVIRONMENT FOR RENEWABLE ENERGY.....	11-1
11.1	Introduction.....	11-1
11.2	Context.....	11-1
11.3	Electricity Supply Policy & Regulation.....	11-2
11.4	Environmental Policy in Relation to Renewable Energy.....	11-7
11.5	RE Project Development.....	11-9
11.6	Financial Issues	11-13
11.7	The State of Renewable Energy Development in Hong Kong	11-15
12	KEY ISSUES AND OPTIONS	12-1
12.1	Introduction.....	12-1
12.2	Setting a Policy and Legislative Framework	12-2
12.3	Securing Grid Access	12-4
12.4	Creating a Market Framework.....	12-5
12.5	Securing Financial Viability.....	12-10
PART D - STRATEGY FOR RENEWABLE ENERGY		
13	STRATEGY AND ACTION PLAN	13-1
13.1	Introduction.....	13-1

13.2	Enabling Measures	13-3
13.3	Technology-Specific Actions.....	13-11
13.4	Supplementary Strategy	13-24
13.5	Promotion and Awareness-Raising Actions.....	13-24
14	TARGETS	14-1
14.1	Defining Targets for Renewable Energy	14-1
14.2	Renewable Energy Targets	14-3
PART E - CONCLUSIONS AND RECOMMENDATIONS		
15	CONCLUSIONS	15-1
15.1	Technology Review	15-1
15.2	Legal & Institutional Issues.....	15-4
16	RECOMMENDATIONS.....	16-1
APPENDIX A COST MODELS		
APPENDIX B TECHNICAL REQUIREMENTS FOR GRID CONNECTION OF LARGER RE GENERATION		
APPENDIX C TECHNICAL GRID CONNECTION ARRANGEMENTS FOR SMALL ACTIVE INVERTER CONNECTED SOURCES		
APPENDIX D TARIFFS OFFERED BY HEC AND CLP - JULY 2001		

List of Tables

Table 4-1: Land Use In Hong Kong (Year 1999)
Table 5-1: Annual Averages Of Daily AC Electrical Output
Table 5-2: Energy Savings Relative To A Conventional In-Line Electric Water Heater
Table 5-3: Assumed PV Deployment Rates And Estimated Potential Resource
Table 6-1: Up-Wind Versus Down-Wind Characteristics
Table 6-2: Summary Of Levelised Cost Of Electricity Of Wind Power Generation
Table 7-1: Summary Of Major Differences Of Fuel Cell Types
Table 7-2: Key Fuel Cell Characteristics Summary
Table 7-3: Fuel Cells Electricity And Thermal Outputs Summary
Table 7-4: Summary Of Fossil Fuel Central Power Plant Ancillary Load Estimate
Table 7-5: Fuel Cell Deployment Options
Table 7-6: Evaluation Of Fuel Cell Deployment Options
Table 8-1: Summary Of Landfill Gas Utilization Options
Table 8-2: Assumed Energy Conversion Factors
Table 8-3: Waste Reduction Target And Projected Waste Requiring Disposal
Table 8-4: Energy Potentials For Bulk MSW Reduction Options
Table 9-1: Theoretical Water Wheel Energy Potential
Table 9-2: Small Scale Hydro Retrofit Scheme Energy Potential
Table 9-3: Summary Of Overseas Tidal Plants
Table 9-4: Summary Of 1999 Recorded Tidal Data
Table 9-5: Tidal Resource Potential
Table 10-1: Proposed Categorisation Of NRE Options
Table 11-1: Definition Of Terms In Statutory Plans
Table 11-2: Energy From Waste Projects Installed Or Under Development
Table 11-3: Wind Projects Installed Or Under Development
Table 11-4: Solar PV Projects Installed Or Under Development
Table 12-1: Composition Of CLP's Electricity Sales In Hong Kong By Customer Type, 2000
Table 12-2: Issues Related To Green Power Scheme
Table 12-3: Application Of Financial Support & Incentive Packages To Technology Types
Table 12-4: Option Assessment
Table 13-1: Market Penetration Of Wind Power (Gwh/Yr)
Table 13-2: Energy Output From Wind Projects Under Alternative Scenarios
Table 13-3: Contribution Of Energy From Waste (Landfill Gas Scenario)
Table 13-4: Contribution Of Energy From Waste (Thermal Treatment Scenario)
Table 13-5: Market Penetration Of BIPV (Gwh/Yr)
Table 14-1: Summary Of Contributions From Local RE Sources (Gwh/Y)

List of Figures

- Figure 2-1: Stage 1 Study Tasks Flow
- Figure 3-1: Approach to Technologies Review
- Figure 4-1: Electricity Consumption by End-use (1989 - 1999) (Source: Hong Kong Energy End-use Data, 1989 - 1999, EMSD)
- Figure 4-2: Town Gas and LPG Consumption by End-use (1989 - 1999) (Source: Hong Kong Energy End-use Data, 1989 - 1999, EMSD)
- Figure 4-3: Estimated Hong Kong Average Residential Customer Load Profile
- Figure 4-4: Estimated Average Monthly Residential Town Gas Consumption
- Figure 4-5: Estimated Average Commercial Customer Load Profile
- Figure 4-6: Estimated Average Monthly Commercial Town Gas Consumption
- Figure 4-7: Estimated Average Industrial Customer Load Profile
- Figure 4-8: Estimated Average Monthly Industrial Town Gas Consumption
- Figure 4-9: Major Development Constraints in Hong Kong (Source: Hong Kong 2030 web site)
- Figure 5-1: Field of fixed, tilted PV arrays in the exclusion zone around a nuclear power station, California (Source: NREL, DOE)
- Figure 5-2: Semi-transparent office façade
- Figure 5-3: Simplified schematic diagram for a grid-connected PV system
- Figure 5-4: Simplified schematic diagram for a stand-alone PV system
- Figure 5-5: Global and direct insolation on a horizontal surface in Hong Kong
- Figure 5-6: Comparison of Insolation
- Figure 5-7: Solar Parabolic Trough Concept
- Figure 5-8: View of rows of troughs at Mojave Desert, USA
- Figure 5-9: Solar Power Tower Concept
- Figure 5-10: Solar One
- Figure 5-11: Solar Dish/Engine System Concept
- Figure 5-12: Fresnel Concentrator with Stationary Absorber
- Figure 5-13: Close-coupled Thermosyphon System
- Figure 5-14: Flat Plate Evacuated Collector
- Figure 5-15: Evacuated tube collector mounted on balcony of a high rise building
- Figure 5-16: Large scale evacuated tube solar collector array
- Figure 6-1: Vertical axis wind turbine (Source: NREL, US DOE)
- Figure 6-2: Horizontal axis wind turbine (Source: NREL, US DOE)
- Figure 6-3: Land-based Wind Farm (Linear Arrangement)
- Figure 6-4: Near Shore Wind Farms
- Figure 6-5: Wind Power Density over the Region of Hong Kong
- Figure 6-6: Areas of High Relative Wind Resource in the Hong Kong Region
- Figure 6-7: Areas of High Offshore Wind Resources in Hong Kong Territorial Waters
- Figure 7-1: Basic Fuel Cell Diagram
- Figure 7-2: PEM Fuel Cell Electrochemical Reaction
- Figure 7-3: SOFC Stack Configurations (Source: US DOE)
- Figure 7-4: SOFC Electrochemical Reaction Illustration
- Figure 7-5: Ballard Generating System's 250 kW PEMFC Unit

Figure 7-6: FCE 1 MW MCFC Power Plant

Figure 7-7: Residential Fuel Cell Capacity Factor versus Size

Figure 7-8: Commercial Customer Fuel Cell Capacity Factor versus Size

Figure 7-9: Industrial Customer Fuel Cell Capacity Factor

Figure 8-1: Material/Energy Flow Diagram – Option 1 (Year 2007)

Figure 8-2: Material/Energy Flow Diagram – Option 2 (Year 2007)

Figure 8-3: Material/Energy Flow Diagram – Option 3 (Year 2007)

Figure 9-1: Small Hydro System (Run of River)

Figure 9-2: Details of Run of River Scheme Principle (Source: Western Power Corporation)

Figure 9-3: Conceptual Retrofit Hydroelectric System (High Island to Shatin Treatment Works)

Figure 9-4: Conceptual Retrofit Hydroelectric System (Lower Shing Mun Reservoir to Shatin Supply Basin)

Figure 9-5: Conceptual Retrofit Hydroelectric System (Jubilee Reservoir to Shing Mun Reservoir)

Figure 9-6: Impression of Tidal Power (Source: Australian Greenhouse Office)

Figure 9-7: La Rance 240 MW Station in France (Source: Australian Greenhouse Office)

Figure 9-8: The Impounded Basin Option at Tolo Harbour

Figure 9-9: An Oscillating Water Column Energy Wave Energy Recovery Device (Source: Itagemen 1992)

Figure 9-10: TAPCHAN System (Source: Australian Greenhouse Office)

Figure 9-11: Hose Pump Operating Principle

Figure 9-12: Geothermal/Hydrothermal Resource

Figure 9-13: Dry Steam Power Plant (Source: Geothermal Education Office, California, USA - website)

Figure 9-14: Flash Steam Power Plant

Figure 9-15: Binary Cycle Power Plant

Figure 9-16: Regions of High Geothermal Potential

Figure 9-17: Steam Driven Geothermal Plant

Figure 9-18: Regional Geological Map

Figure 9-19: Concept of an Integrated Renewables and Hydrogen Storage System

Figure 12-1: Time of use tariff for Supplies to Large Customers and for Purchase of Electricity

Figure 12-2: Basic operation of a Green Electricity Scheme

Figure 16-1: Renewable Strategy & Action Plan – Consolidated programme

PART A

INTRODUCTION

1 INTRODUCTION

1.1 BACKGROUND

As a small place with no indigenous energy resources such as oil, gas or coal, Hong Kong has been relying mainly on imported fossil fuels to support its energy sector¹. In terms of electricity supply, two independent power companies, each providing generation, transmission, distribution and retailing of electricity, serve all major residential, commercial and industrial developments in the SAR. Coal and, more recently, natural gas are imported to generate electricity locally at three power stations.

Public awareness of energy efficiency and environmental protection has become more prominent recently. For example, Hong Kong has undertaken “to contribute to international efforts to stabilise greenhouse gas concentrations in the atmosphere”. Greenhouse gas (GHG) emissions such as carbon dioxide are largely by-products of burning fossil fuels. The energy sector is the largest contributor to Hong Kong’s carbon dioxide emissions, responsible for about 97% of the total carbon dioxide emissions, and most of which comes from electricity generation. At present, energy is untaxed, and there are no “eco-taxes” (e.g., carbon tax or SO_x/NO_x tax) to internalise local or global pollution costs associated with fossil fuel combustion.

Reduction of GHG emissions due to electricity generation may be achieved through several means, including use of alternative fuels and renewable energy sources. It is worthy to note that all new power plants commissioned in Hong Kong since 1996 have been using natural gas as fuel, which emits about 50% less carbon dioxide than coal. While renewable energy sources have been used in large-scale power generation in some overseas countries, it is unclear if this would be applicable in Hong Kong.

1.2 POLICY CONTEXT

At present, the two objectives under the energy policy are:

- ❑ Ensure the energy needs of the community are met safely, efficiently and at reasonable prices; and
- ❑ Minimise the environmental impact of energy production and use, and promote the efficient use and conservation of energy.

Increasing the contribution that renewable energy² sources make to meeting local energy demand will support existing government policies aimed at minimising the environmental impact of energy production and promoting the efficient use and conservation of energy. It will contribute to international efforts to reduce greenhouse gas emissions into the atmosphere and improve compliance with air quality objectives.

¹ Energy sector includes electricity generation, manufacturing and construction, transport and other fuel combustion industries.

² The term “renewable energy” may be defined in several ways, and there is not at present a universally accepted definition. Generally speaking, renewable energy sources are secure and inexhaustible, in the sense that there is no problem of reserves being depleted.

Finally, increasing the proportion of energy needs met from renewable sources will also increase diversity of energy supply options, so helping to reduce reliance on imported energy or fuel, and increase security of energy supply.

Consistent with these policy objectives, the Government has considered it opportune to examine the potential for application of renewable energy in Hong Kong. Accordingly, the Electrical and Mechanical Services Department has commissioned this *Study on the Potential Applications of Renewable Energy in Hong Kong* (hereinafter referred to as the Study).

1.3 STUDY OBJECTIVES

The Study is structured into two stages, with the objectives of:

Stage 1 of Study

- ❑ Review the latest developments in renewable energy (RE) technologies world wide through a literature search and desktop study;
- ❑ Examine the potential for wide-scale³ adoptions of suitable RE technologies in Hong Kong in the short and long term;
- ❑ Assess the feasibility and potential for wider application of new⁴ and renewable energy technologies as alternative forms of energy sources in Hong Kong; and
- ❑ Devise a strategy for implementation.

Stage 2 of Study

- ❑ Conduct a pilot project to demonstrate the applicability of Building Integrated Photovoltaic (BIPV) systems.

This report summarises the principal findings of Stage 1 of the Study. The Stage 2 BIPV demonstration project will be reported separately.

³ "Wide scale" use is taken to mean application of the technologies for community-scale use in centralised or distributed arrangement, with sufficient power and energy for distant transmission if they are located in areas remote from the loads.

⁴ New energy technologies include "non-conventional" power generation as well as energy storage technologies. Note that these are not necessarily renewable energy technologies. An example is "fuel cells", some types of which can use fossil fuels such as natural gas to generate electricity.

2 STAGE 1 STUDY OBJECTIVE, SCOPE AND REPORT STRUCTURE

2.1 OBJECTIVE AND SCOPE

The Stage 1 Study is the first systematic assessment of the potential for renewable energy in Hong Kong. Its primary objective is to identify new and RE technologies that have a potential for wide scale application in Hong Kong and then formulate a “strategy” to facilitate their implementation.

Key tasks in the Stage 1 study have included, as illustrated in *Figure 2-1*:

- ❑ **Technologies Review**, covering solar, wind, biomass, energy-from-waste, small-scale hydroelectric, geothermal, tidal and wave, fuel cells and independent energy storage systems. The objective of this task was to identify those new and RE technologies that have a potential for wide scale application in Hong Kong from the perspective of technical feasibility. The findings of this task are elaborated in Part B of this report;
- ❑ **Analysis of Issues and Barriers**, focusing on those non-technical issues that could constrain wide scale deployment of the identified new and RE technologies, and identifying options to overcome the barriers. Part C of this report summarises the findings of this task; and
- ❑ **Implementation Strategy**, providing an integrated strategy and action plan for implementation of those new and RE energy options that have a potential for wide scale application in Hong Kong. This is presented in Part D of this report.

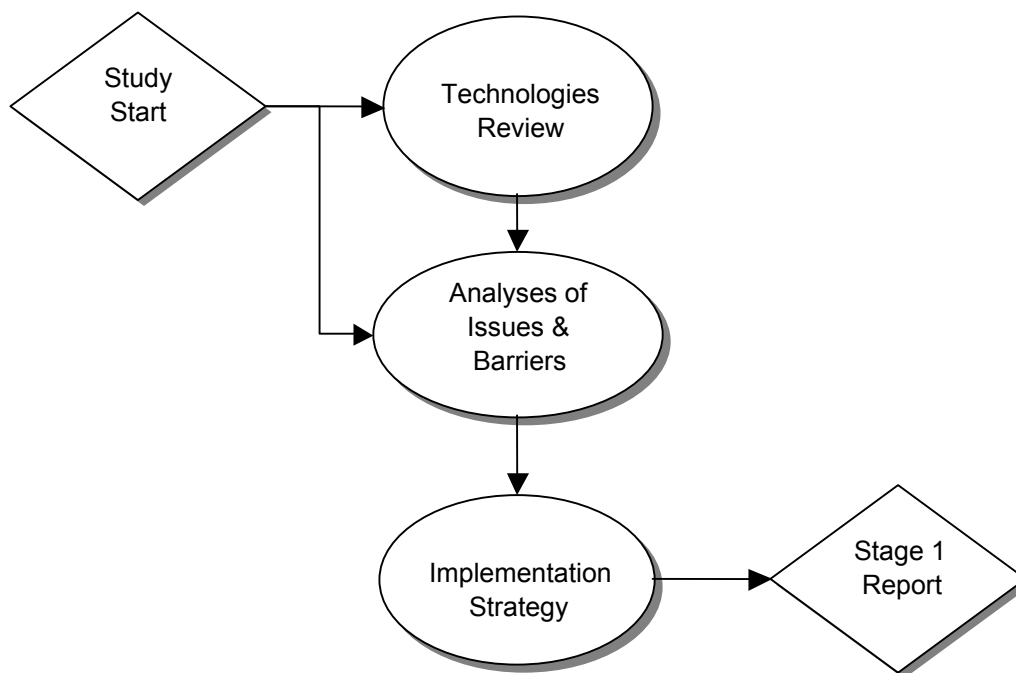

Figure 2-1: Stage 1 Study Tasks Flow

2.2 STRUCTURE OF REPORT

The report is structured into five parts as follows:

PART A: INTRODUCTION

- ❑ Chapter 1 - Introduction
- ❑ Chapter 2 - Stage 1 Study Objective, Scope and Report Structure

PART B: TECHNOLOGIES REVIEW

- ❑ Chapter 3 - Approach to Technologies Review
- ❑ Chapter 4 - Outline of Key Local Characteristics
- ❑ Chapter 5 - Solar Energy
- ❑ Chapter 6 - Wind Energy
- ❑ Chapter 7 - Fuel Cells
- ❑ Chapter 8 - Energy-from-Waste
- ❑ Chapter 9 - Review of Other Resources/Technologies
- ❑ Chapter 10 - Categorisation of Renewable Energy Options

PART C: ISSUES AND BARRIERS

- ❑ Chapter 11 - The Operating Environment for Renewable Energy
- ❑ Chapter 12 - Key Issues and Options

PART D: STRATEGY FOR RENEWABLE ENERGY

- ❑ Chapter 13 - Strategy and Action Plan
- ❑ Chapter 14 - Targets

Part E: CONCLUSIONS AND RECOMMENDATIONS

- ❑ Chapter 15 - Conclusions
- ❑ Chapter 16 - Recommendations

PART B

TECHNOLOGIES REVIEW

3 APPROACH TO TECHNOLOGIES REVIEW

3.1 OVERVIEW

The objective the Technologies Review is to identify new and renewable energy (NRE) technologies that have a potential for wide scale application in Hong Kong. As per Study Brief requirements, the review has covered:

- ❑ Solar;
- ❑ Wind;
- ❑ Fuel cells;
- ❑ Biomass;
- ❑ Energy-from-waste;
- ❑ Small-scale hydroelectric;
- ❑ Geothermal;
- ❑ Tidal and wave; and
- ❑ Independent energy storage systems.

3.2 RESOURCE DEFINITION

In reviewing RE resources, it is important to note that the total amount of a particular form of energy that exists in nature is very often *not* the same as that can be extracted *in practice* after taking into account the many technical and non-technical factors. Recognising this, the following resource definitions are adopted in this Study:

- ❑ *Total Resource* – the total energy content of the RE source in a given time period;
- ❑ *Technical Resource* – the total resource, limited by our technical ability to extract it (i.e., technological limitations);
- ❑ *Potential Resource* – the technical resource, additionally limited by *basic practical incompatibilities* (e.g., roads) that reduce the opportunities of resource capture or technology deployment;
- ❑ *Accessible Resource* – the potential resource, additionally limited by institutional restrictions (e.g., country parks, sites of special scientific interests, etc);
- ❑ *Commercially Viable Resource* – the accessible resource, additionally limited by what the commercial sector considers financially viable; and
- ❑ *Acceptable Resource* – the viable resource, additionally limited by what is acceptable to

society (e.g., visual impacts, planning permission, etc).

The first three (*total*, *technical* and *potential*) resource levels are related to essentially technical factors, while the last three (*accessible*, *commercially viable* and *acceptable*) are governed by non-technical constraints, related primarily to institutional, economical/financial and social factors, some of which are specific to the technologies concerned. As mentioned in Chapter 1, the Technologies Review (Part B of this report) focuses on the technical issues. Analysis of non-technical issues is presented in Part C.

3.3 APPROACH

The approach taken for the Technologies Review is summarised in *Figure 3-1*.

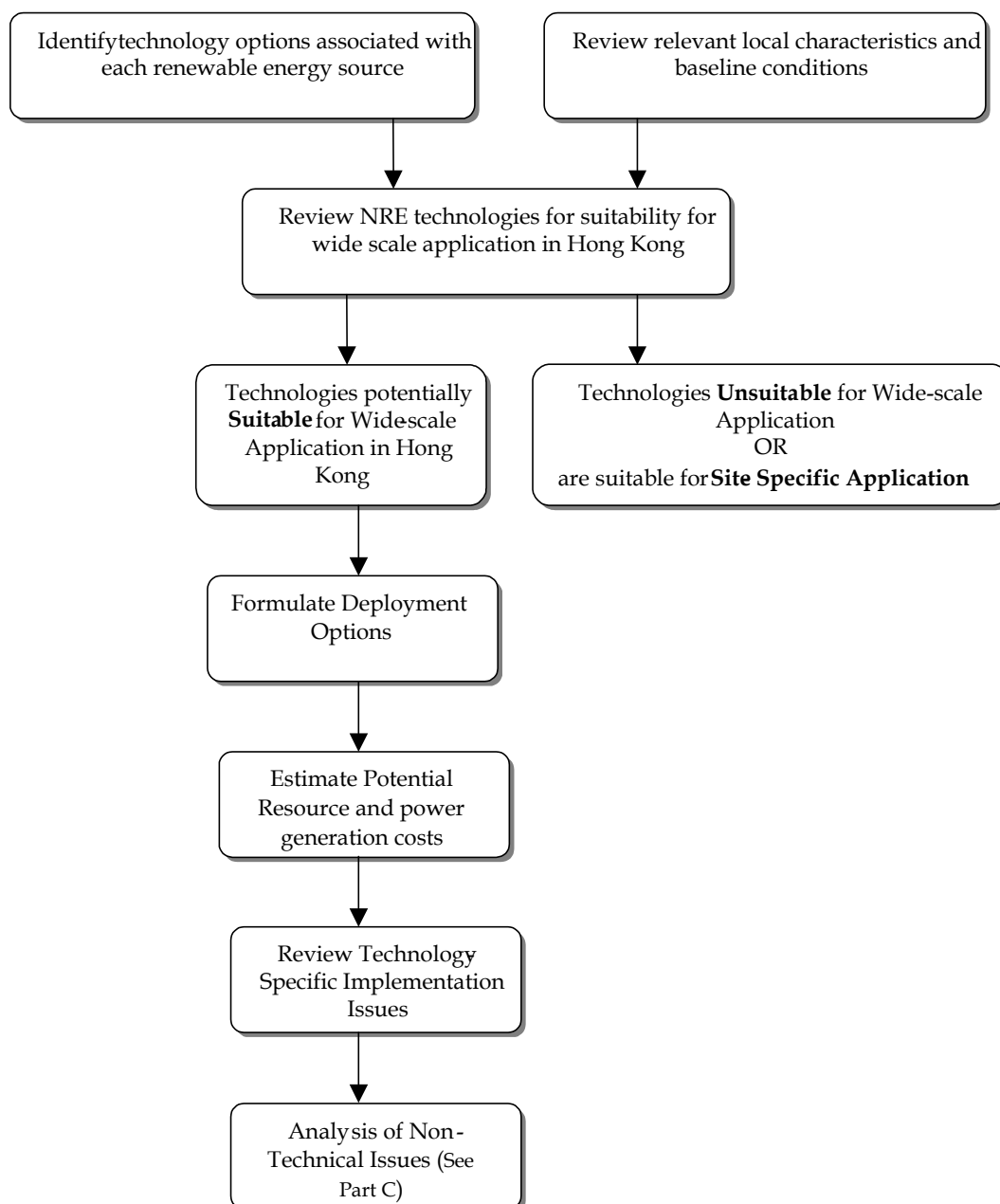

Figure 3-1: Approach to Technologies Review

The following Chapter 4 summarises local characteristics and baseline conditions that are relevant to the development and deployment of new and renewable energy resources or technologies in Hong Kong.

Subsequent Chapters 5, 6, 7 and 8 present reviews of solar, wind, fuel cell and energy-from-waste technologies, respectively, all of which have been identified to have a potential for wide-scale application in Hong Kong. Chapter 9 summarises the other resources/technologies, some of which are unlikely to be suitable for wide-scale application while some could be applied on a site-specific basis.

4 OUTLINE OF KEY LOCAL CHARACTERISTICS

4.1 ENERGY CONSUMPTION PATTERNS

4.1.1 Overview

An understanding of energy use patterns is important to assessing the potential for application of new and renewable energy technology options in Hong Kong.

In Hong Kong, energy is available for local consumption in two principal forms: electricity (125,288 TJ) and gas (29,256 TJ). The commercial sector is by far the largest energy consumer. In 1999, it consumed a total of 91,637 TJ of energy, accounting for about 53% of the SAR's total energy consumption in residential, commercial and industrial sectors except transport. Next was the residential sector (45,681 TJ), which is followed by industrial sector (36,461 TJ).

It is noted that the industrial process/equipment electric consumption has been declining for the last ten years, while both space conditioning and lighting & refrigeration electric consumption continues to increase (see *Figure 4-1*).

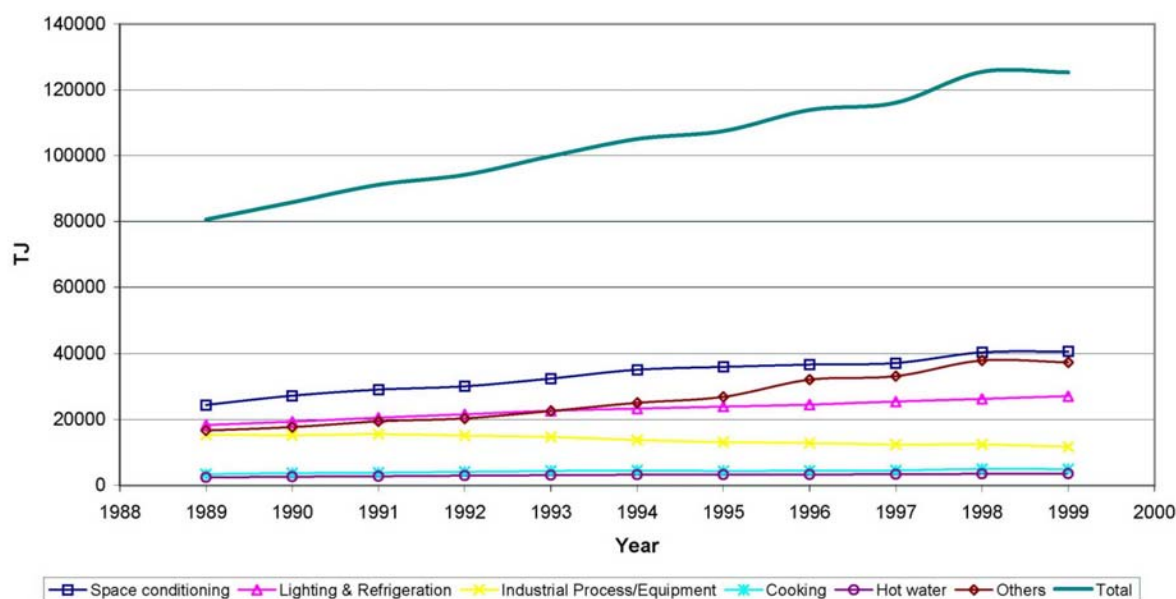

Figure 4-1: Electricity Consumption by End-use (1989 - 1999)
(Source: Hong Kong Energy End-use Data, 1989 - 1999, EMSD)

For town gas & LPG, the largest consumption by end-use is cooking, which consumed 16,673 TJ (about 58% of total gas consumption) in 1999. Next was the hot water (6,943 TJ) (see *Figure 4-2*).

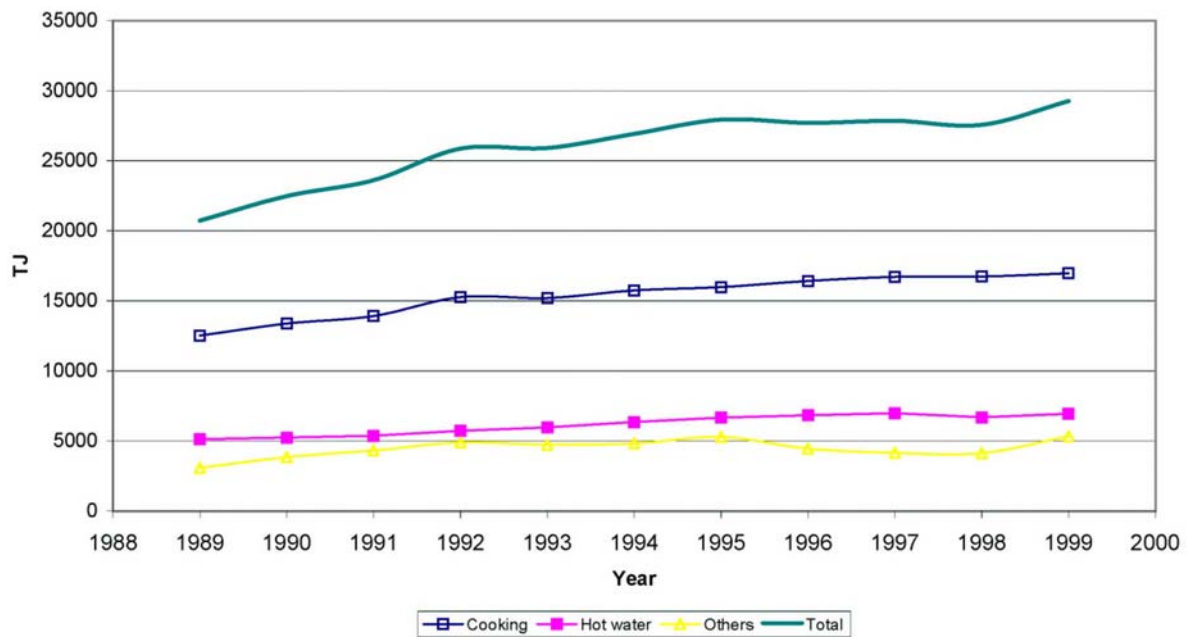

Figure 4-2: Town Gas and LPG Consumption by End-use (1989 - 1999)
(Source: Hong Kong Energy End-use Data, 1989 - 1999, EMSD)

4.1.2 Residential Demand Profile

According to the Hong Kong Government there were 2,132,000 residential flats in 1999. Much of the housing are assumed to be in the 20 to 40 m² (215 to 430 ft²) (*Census & Statistics Department, Stock of Permanent Living Quarters Website*).

An analysis of the electricity demand profile reveals that most of the demand occurs in the morning and evening/night hours. *Figure 4-3* shows the “average daily electric demand” profile for each month of the year. In cooler months the demand is as low as 250 W in the middle of the day. Peak demand occurs at night and is as high as 1,300 W.

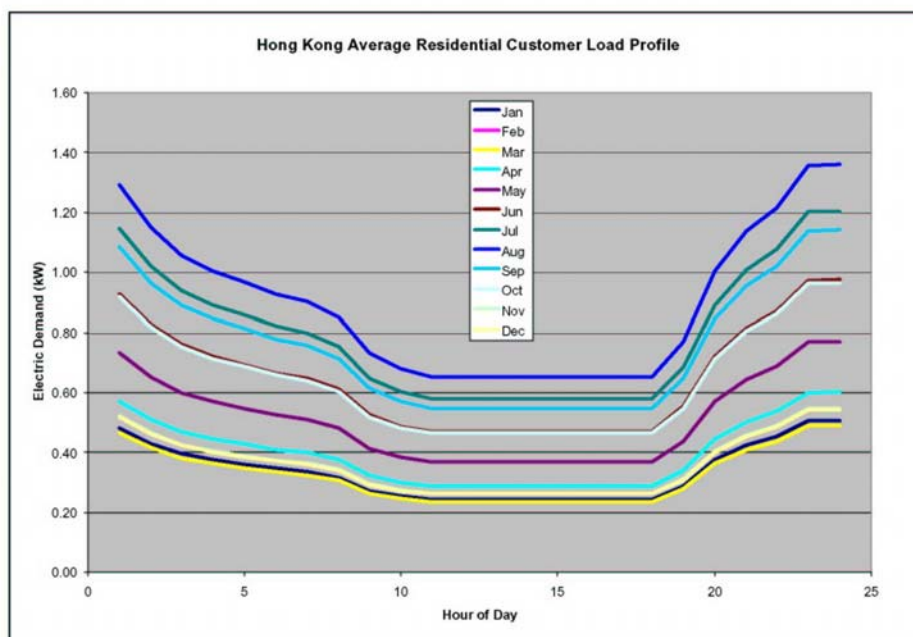

Figure 4-3: Estimated Hong Kong Average Residential Customer Load Profile

Average monthly town gas consumption for residential customers is shown in *Figure 4-4*. There are approximately 1.2 million residential town gas customers. It is estimated that there are another 316,000 residential LPG customers. Residential gas consumers represent the largest town gas load in aggregate. There is some space heating, but the majority of gas load is cooking and domestic hot water heating. The Government has encouraged the installation of piped gas supply in new buildings to discourage further growth in the use of LPG cylinders in domestic dwellings. Therefore, it is expected the future use of LPG to decrease in proportion to the total number of gas customers.

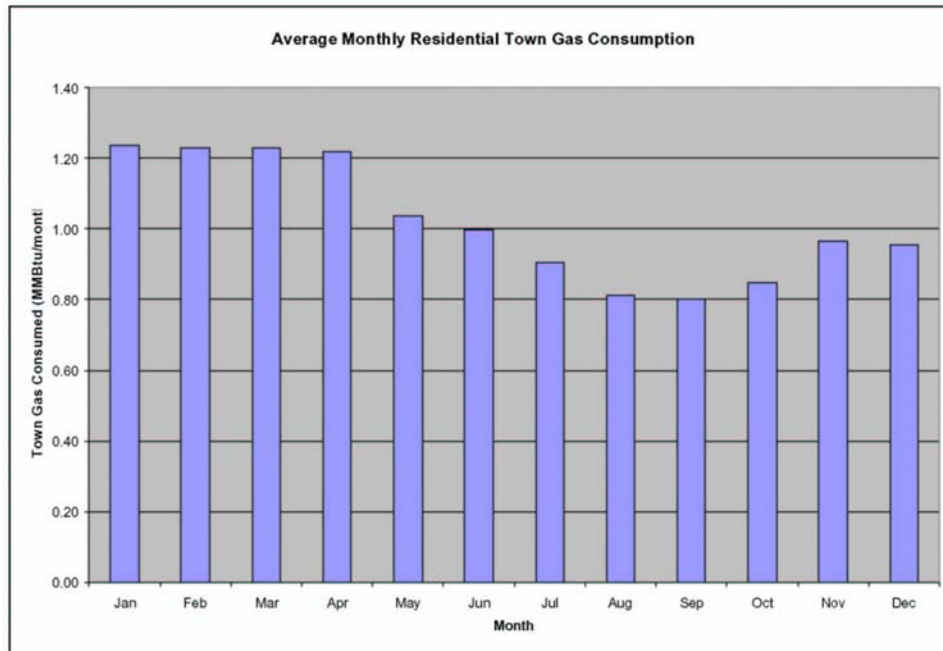

Figure 4-4: Estimated Average Monthly Residential Town Gas Consumption

4.1.3 Commercial Demand Profile

Commercial sector facilities include office, retail stores, restaurants, hospitals, schools, and public assembly buildings. Hong Kong commercial buildings are mostly multi-storey, high rise facilities, largely found in the dense urban areas. Hong Kong’s service economy requires a large stock of commercial buildings to support business activities.

It has been estimated that the number of electric commercial customers is 428,500 of which 290,000 are also town gas or LPG customers. The commercial customer “average hourly electric demand” profile for each month of the year is illustrated in *Figure 4-5*.

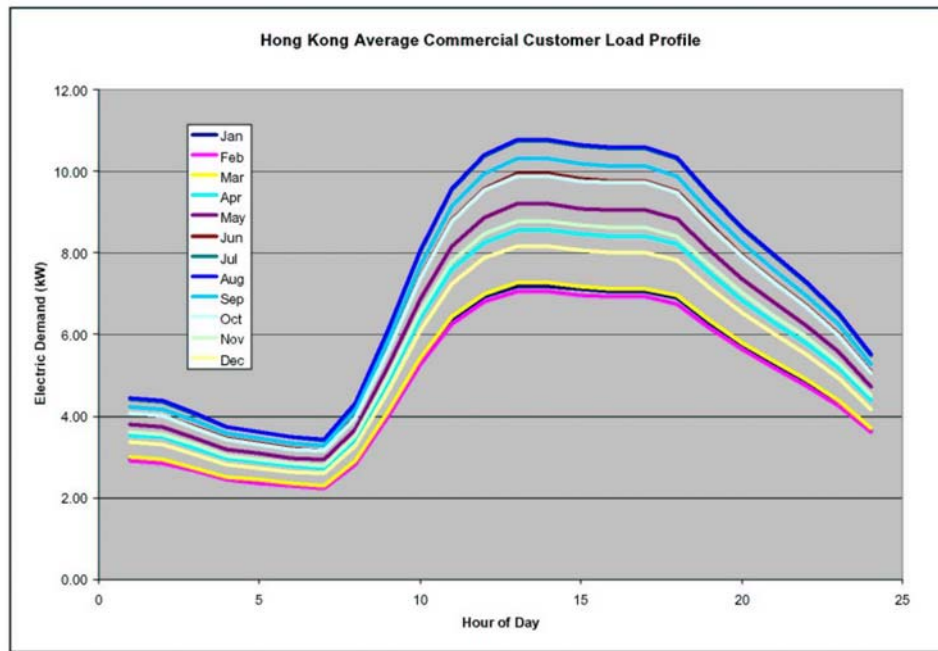

Figure 4-5: Estimated Average Commercial Customer Load Profile

Electric demand appears to be driven primarily by business hours when lights, communications, computers, copiers, and HVAC are operating. In addition, there appears to be a significant influence of air conditioning load especially during July, August, and September periods.

It is assumed that average gaseous fuel consumption is similar between LPG and town gas commercial customers. *Figure 4-6* charts the monthly average gas consumption for commercial customers.

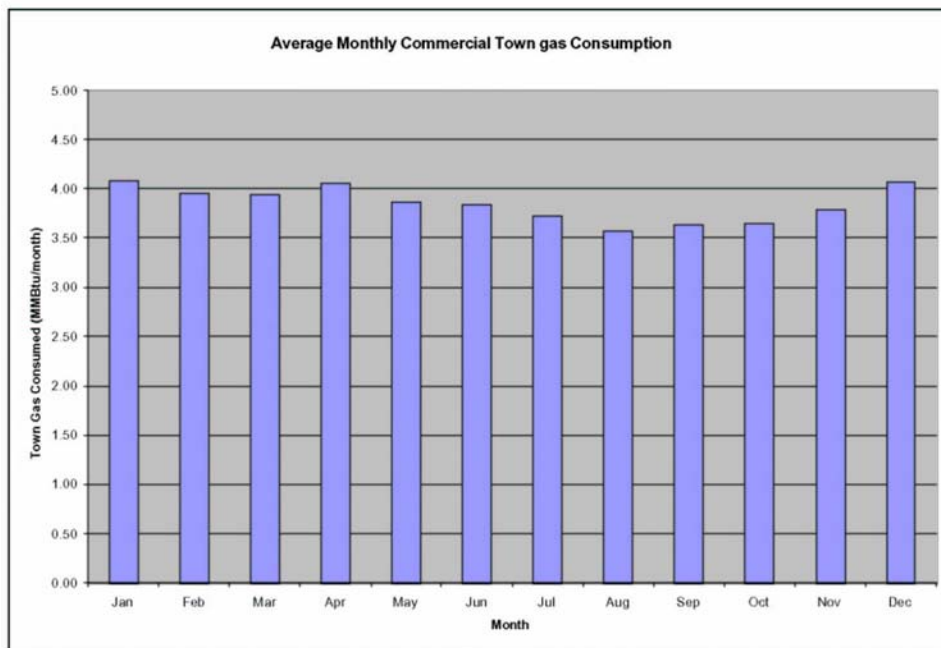

Figure 4-6: Estimated Average Monthly Commercial Town Gas Consumption

Although total gas consumption for the commercial customer sector is smaller than residential, the average use per customer is higher. Commercial gas use is relatively flat through out the year, suggesting that hot water heating and cooking, instead of space heating, dominate.

4.1.4 Industrial Demand Profile

Hong Kong industry primarily consists of clothing manufacturing, electronics, textiles, and watches/clocks. There are references to some chemical and other processing industries, but it is believed that these energy customers are small in number. Our analysis suggests the total number of industrial electric customers at approximately 28,000. However, it has been estimates that the number of industrial gas fuel customers is 18,600 or 66% of the number of industrial electric customers.

From historical electric data, it was able to estimate the average hourly demand profile for industrial customers. These estimates are charted in *Figure 4-7*.

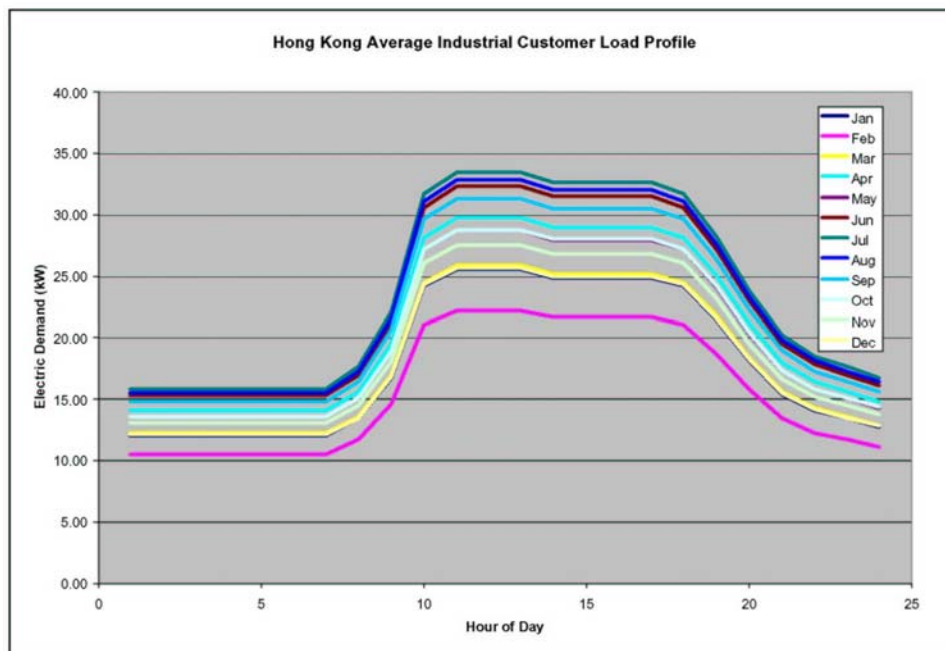

Figure 4-7: Estimated Average Industrial Customer Load Profile

The industry sector average monthly gas fuel consumption per customer is illustrated in *Figure 4-8*.

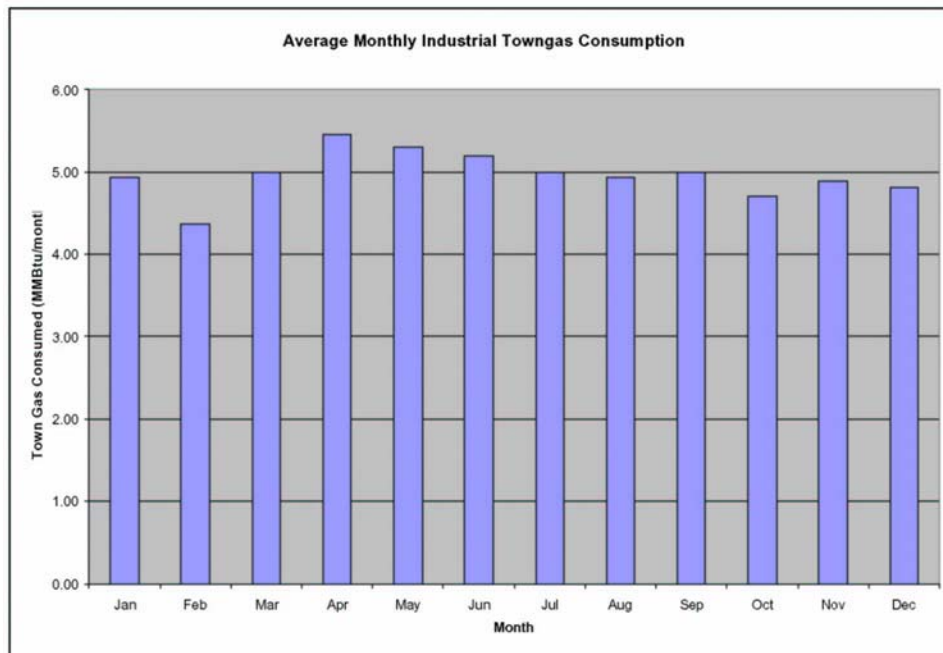

Figure 4-8: Estimated Average Monthly Industrial Town Gas Consumption

The average annual electric load factor for industrial customers is approximately 61% which is higher than commercial customer load factor (56%) or residential (39%).

4.2 KEY LOCAL CHARACTERISTICS

Hong Kong has a total territorial area of about 2,757 km², consisting of 1,098 km² of land and 1,659 km² of sea. Land uses include a diverse range of developed areas, natural and managed habitats, and urban open space. *Table 4-1* is a summary of land uses in Hong Kong.

Table 4-1: Land Use in Hong Kong (Year 1999)

Land Use	Percentage	Approximate Area (km ²)
Commercial	0.2	2
Residential	4.1	45
Public rental housing	1.3	14
Industrial	1.0	11
Open Space	1.5	17
Government, institution and community facilities	1.9	21
Vacant development land	2.4	27
Roads/Railways	3.0	33
Temporary housing areas	0.1	1
Airport	1.2	13
Woodlands	20	220
Grass and shrubs	47.3	519
Badlands, swamp and mangrove	4.0	44
Arable	5.4	59
Fish ponds	1.3	14

Temporary structures/livestock farms	1.0	11
Reservoir	2.4	26
Other uses	1.9	21
Total	100	1,098

Source: *Land Usage as at 31 March 1999, Land, Public Works and Utilities – Chapter 13*

However, land suitable for development is extremely limited, due to topographical constraints and existing developments. The marine waters of Hong Kong are used for a variety of beneficial purposes, including commercial shipping, fisheries, marine disposal sites, recreation (e.g., boating, beaches) and conservation (e.g., marine reserves). *Figure 4-9* summarises the major development constraints in Hong Kong.

A significant proportion of the land (815 km²) is for open space, woodlands, grass, and shrubs, of which just over half (415 km²) are designated as Country Parks or Special Areas. Built up areas (including commercial, residential, housing, industrial, vacant development land, institutional, community, roads, railways and airports) occupy only 167 km². Within these very densely populated and highly urbanised areas, there are many high-rise residential and commercial buildings consuming a significant amount of energy.

Given Hong Kong's small size and densely populated nature, it is clear that deployment and siting of any new and renewable energy systems, particularly those involving large centralised generation facilities, must take into account a range of land and marine constraints. However, while there are likely many constraints to development of large scale facilities in urban areas, there are potential opportunities for deployment of distributed or embedded non-polluting renewable energy systems at individual localities, including new and redeveloped urban areas. This is particularly relevant given buildings are the most significant electricity users in Hong Kong.

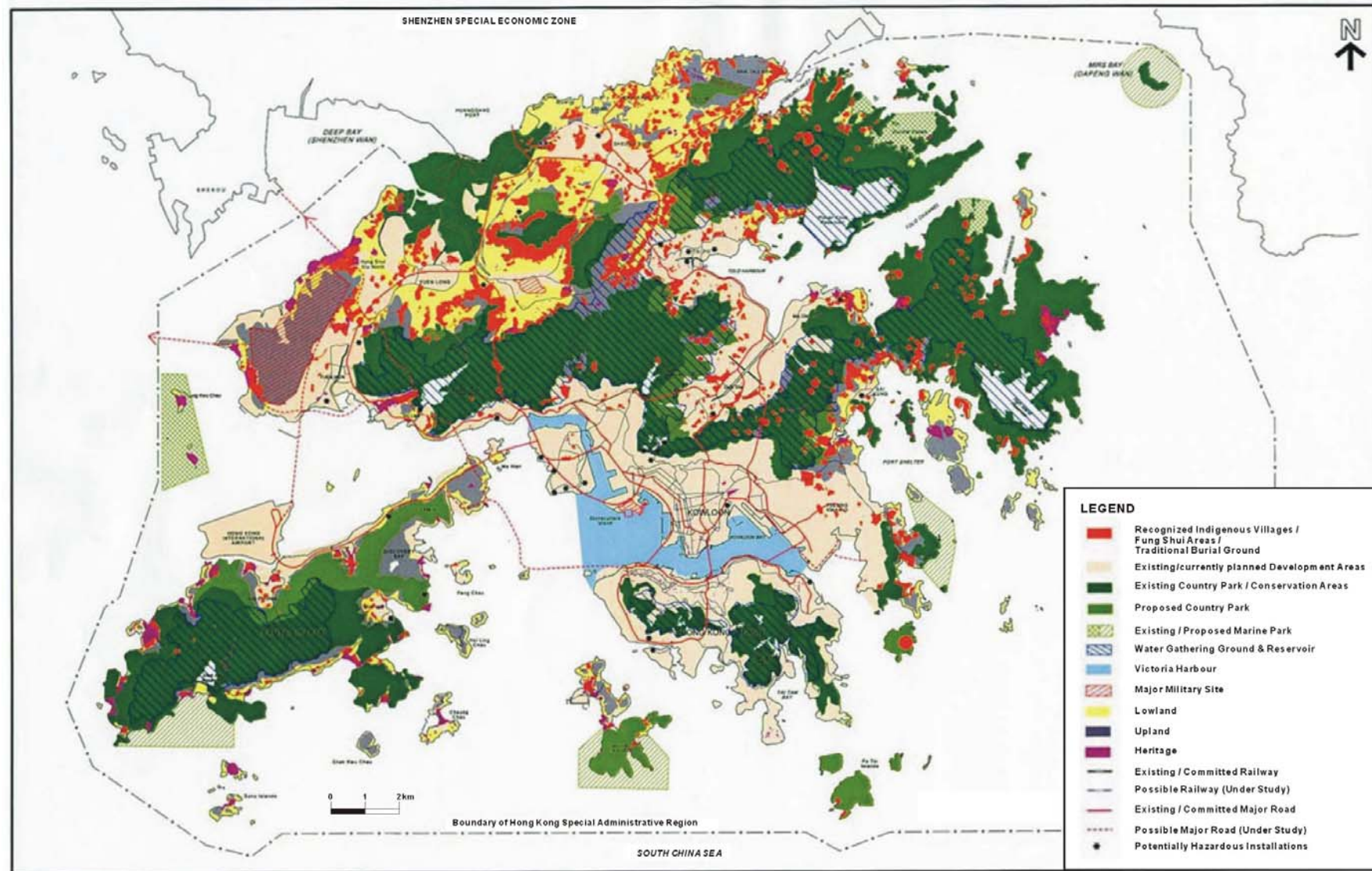

Figure 4-9: Major Development Constraints in Hong Kong (Source: Hong Kong 2030 web site)

5 SOLAR ENERGY

5.1 OVERVIEW

Sunlight is the world's largest energy resource. It can be converted into useful energy directly using various technologies grouped under two fundamental categories:

- ❑ *Solar Photovoltaic (PV)*. Solar radiation can be converted directly into electricity using photovoltaic devices (solar cells). This technology is relatively new, as the solar cell was only first successfully developed in 1975. However, PV technology has progressed significantly since then, and has become the primary form of solar energy application.
- ❑ *Solar Thermal* refers to the utilisation of the *heat* energy from the sun. Firstly, solar radiation can be absorbed in solar "collectors" to provide solar space or water heating at relatively low temperatures. In large-scale applications, solar radiation can be concentrated by parabolic mirrors to provide high temperatures, which may then be used either for direct heating purposes or to generate *electricity* (for example, via a conventional heat engine).

These technologies are further elaborated below, followed by a preliminary assessment of their relative suitability for application in Hong Kong.

5.2 PHOTOVOLTAIC (PV)

Photovoltaic (PV) devices, or solar cells, directly and silently convert light energy to electricity. Virtually no post-installation energy input other than the light source, normally the sun, is required. Its inherent modularity allows systems to be installed in smaller capacity increments than most other electrical generation technologies.

5.2.1 Types of Cells

There is a wide range of solar cell technologies competing for the terrestrial PV market and the most important ones are:

- ❑ *Wafer-based cells and modules*, which include mono-crystalline, multi-crystalline, ribbon silicon, GaAs (gallium arsenide) and similar materials. Typical module efficiency of mono- and multi-crystalline, which supplied 83% of the market in the year 1998, have efficiencies around 11% to 13%; and
- ❑ *Thin film cells*, the most common of which is amorphous cells and modules, which are very widely used in consumer products, semitransparent modules for car sunroofs, and standalone and remote PV power systems. Relative to wafer-based silicon, amorphous cells have lower cost but also lower efficiency. The best commercial module is around 6% to 7% of efficiency.

5.2.2 Photovoltaic Modules Mounting Methods

In wafer-based technologies individual cells are manufactured, interconnected and assembled into a glass-fronted module and protected from mechanical stress, moisture, dust,

salt, hail, etc. The glass must have good transmission of the light wavelengths to which the cells are expected to respond and provide an abrasion-resistant, non-staining, “self-cleaning” surface. Tempered low-iron glass is often used. Much consideration are need to prevent mismatch of cells or modules, capturing of reflected lights, material degradation, spot heating, etc.

The simplest, most reliable mounting arrangement is to fix *flat-plate module* (see *Figure 5-1* for example) in position. They are usually tilted at approximately the latitude angle to maximise power production. Flat plate modules can be made to rotate about one or two axes to follow the sun to increase power production and they are known as *tracking flat plate collectors*. For potential savings in solar cell cost, tracking *concentrators* are sometimes used to concentrate sun energy collected over a large area onto a small solar cell area. However, concentrators are not capable of using diffuse light that is available to flat plat systems.



Figure 5-1: Field of fixed, tilted PV arrays in the exclusion zone around a nuclear power station, California (Source: NREL, DOE)

5.2.3 Building Integrated Photovoltaic (BIPV) System

BIPV systems are aimed at improving overall costs via the structural integration of PV into the building envelope and they provide novel and aesthetically pleasing architectural alternatives. Appearance is a major factor in the way that solar cells are made and arrayed in building design. The same is true of the colour of the cells. Because the best performance cells are an opaque dark blue, cell colour then becomes a matter not only for the solar engineer, but also for the architect. Although cells can be coloured, the process of colouration is expensive and greatly reduces efficiency. Solar design is compromised further by the requirement that the cell does not give off excessive glare, so that surface texturing must also be reduced.

Architectural design generally calls for some degree of transparency within building surfaces to allow for daylighting. While there is normally a performance disadvantage in relation to PV technology efficiencies, the admission of good natural light into the building can increase productivity in an office environment. *Figure 5-2* is an example of a semi-transparent office façade, where the array was fabricated so that there is plenty of room between the cells.



Figure 5-2: Semi-transparent office façade

A pilot study on the use of BIPV systems for high-rise buildings in Hong Kong is being conducted as part of this Study. The results of the pilot project will be reported separately.

5.2.4 Balance of System

PV modules, configured to suit a particular application, are but one component within a PV system. While the majority of initial system capital cost may be attributed to the PV array, it is the “balance of the system” components that most affect reliability, efficiency and safety of the overall installation

PV modules produce a variable and unpredictable output based on constantly changing insolation levels. The electricity produced by a PV module is direct current (DC). This DC must be converted to alternating current (AC) by inverter and adjusted to meet the power characteristics of the utility grid or the load. *Figure 5-3* and *Figure 5-4* are schematic illustrations of standalone and grid-connected PV systems, respectively.

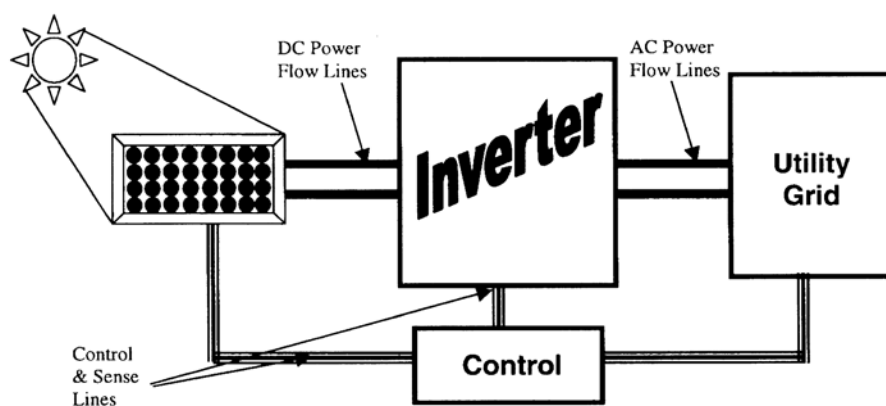

Figure 5-3: Simplified schematic diagram for a grid-connected PV system

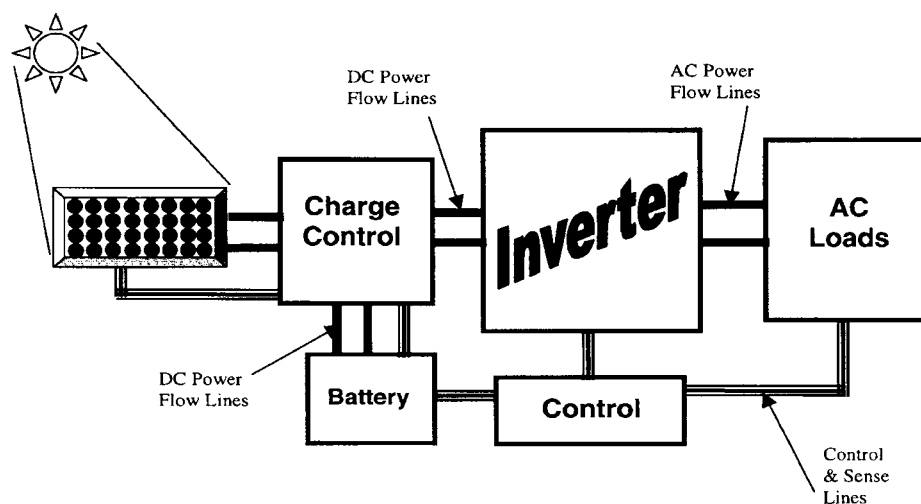

Figure 5-4: Simplified schematic diagram for a stand-alone PV system

Note the grid-connected PV system treats the grid source as both storage element and back-up generator, thus eliminating a great deal of the complexity and reliability risk associated with the number of components and moving parts in the system.

5.2.5 Estimated Energy Yield

The energy yield of a PV system depend on several factors, including the solar resource, efficiency of the PV cell and the way it is installed. These are elaborated below.

5.2.5.1 Monthly and Annual Radiation on a Horizontal Surface

Measurements of both global and diffuse insolation have reportedly been made since 1991 at City University of Hong Kong, though the direct beam component of the insolation (to which a concentrating photovoltaic system would respond) has not been measured. The direct component is found simply by subtracting the diffuse from the global. The global and direct insolation through the year is shown in *Figure 5-5*. This shows that the direct beam component accounts for a very small proportion (as low as 25%) of the global insolation throughout the year except summer. During summer, the proportion of direct beam is higher (between 50% and 60%). Overall, the annual proportion of the direct beam component is relatively low (less than 50%), suggesting that solar concentrator technology is unlikely to be effective for Hong Kong.

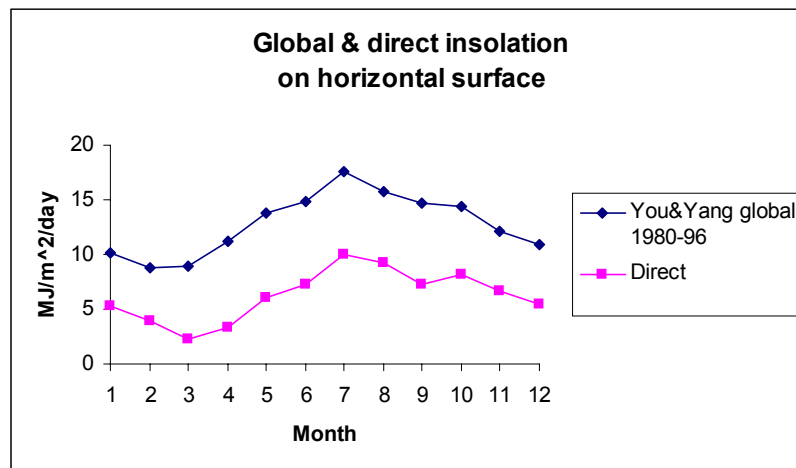

Figure 5-5: Global and direct insolation on a horizontal surface in Hong Kong

5.2.5.2 Monthly and Annual Radiation on a Fixed Tilted Surface

The effect of array tilt has been estimated using the Nsol!, a tested and conservative computer program developed by Orion Energy Corp. This has found that tilting the array above horizontal reduces summer insolation and increases winter insolation. The effect on the annual average is to produce a peak for a tilt of around 14 – 20°.

Figure 5-6 shows how the insolation on walls facing south and east or west (east and west are identical in the model) compares with an “optimally tilted” surface. The east or west orientation has a lower annual average insolation than a south-facing wall (7.02 versus 7.38 MJ/m²/day) but has greater insolation during summer and autumn when the electrical load is at its peak. However, the output from an east or west-facing vertical array will be only marginally higher than from a south-facing vertical array in September.

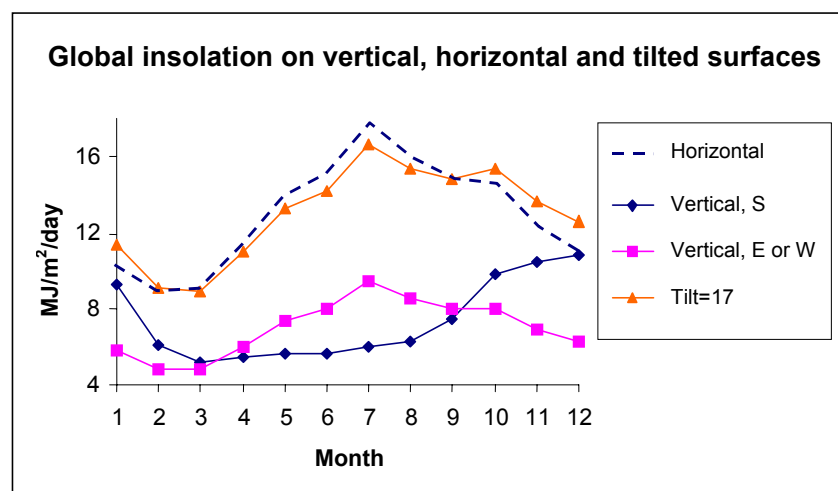

Figure 5-6: Comparison of Insolation

The insolation on vertical surfaces is significantly less than that on horizontal or slightly tilted surfaces. This indicates that roofs are much more attractive than walls for mounting photovoltaics. Mounting arrays vertically rather than at optimal tilt angle will result in

effective annual energy losses of 43% (for south-facing wall) to 46% (for east- or west-facing wall).

5.2.5.3 Monthly and Annual Power Output

The array output power may be obtained from the estimated insolation by multiplication by the minimum module efficiency at the estimated operating temperature and by allowing for blockage of light by accumulated dirt, bird droppings, etc. Annual daily averages for two typical overall system efficiencies are listed in *Table 5-1*.

Table 5-1: Annual Averages of Daily AC Electrical Output

Orientation of modules	Annual average of daily AC output (MJ/m ² /day)*	
	9.3% system efficiency	10.8% system efficiency
Fixed, tilted 17° towards south	1.21	1.41
Horizontal	1.19	1.38
Vertical, south wall	0.69	0.80
Vertical, east or west wall	0.65	0.76
Two-axis tracking, flat plate	1.46	1.70

Note: *Values may be converted to units of kWh/m²/day by division by 3.6

5.2.6 Discussion

Electrical energy output has been estimated using realistic overall system efficiency. For example, a typical horizontally mounted flat PV system is expected to generate about 1.19 MJ/m²/day of AC, or about 121 kWh/yr per m² of PV panel. The total energy resource available from solar PV technology is therefore related to the area of horizontal surfaces (and vertical also, though this is much less efficient) that is available for PV panel installation.

Hong Kong has a total land area of 1,098 km². If these were all fitted with horizontal PV panels, the total energy available would be 133 TWh per year. This would be sufficient to meet the SAR's current annual electricity demand (which was about 35.5 TWh in 1999). Obviously, the area that is actually available for PV panel installation would be much smaller due to many other land uses and constraints. However, PV systems can be integrated into buildings making use of otherwise alienated space, and have a potential for wide-scale application in Hong Kong. Issues and options relating to the application of PV systems in Hong Kong are further discussed in Section 5.5.

5.3 SOLAR THERMAL POWER (ELECTRICITY GENERATING) TECHNOLOGY

Solar thermal power (electricity generation) systems must concentrate large amounts of solar radiation onto a small area to produce high temperature output. Steam is then produced which in turn drives a turbine-generator to produce electricity. Such systems are normally "hybridised" with conventional power systems and in some cases utilise thermal storage. The primary advantage of hybridisation and thermal storage is that a system can be designed to provide "dispatchable" power and operate during periods when solar energy is not available. Common solar thermal power systems include:

5.3.1 Parabolic Trough Systems

This system uses parabolic trough-shaped mirrors (*Figure 5-7*) to focus sunlight on a receiver tube that carries a heat transfer fluid. This fluid is heated and then pumped through a series of heat exchangers to produce steam to power a conventional turbine-generator, producing electricity. Parabolic trough technology is currently the most proven solar thermal electric technology, due primarily to nine large commercial-scale solar power plants, the first of which started operation in 1984 in the California Mojave Desert, USA (see *Figure 5-8*).

The nine trough systems are currently generating 354 MWe. These systems, sized between 14 and 80 MW, are hybridised with up to 25% natural gas in order to provide dispatchable power when solar energy is not available. Operating temperature is about 390°C. Net annual efficiency is 11% to 16%.

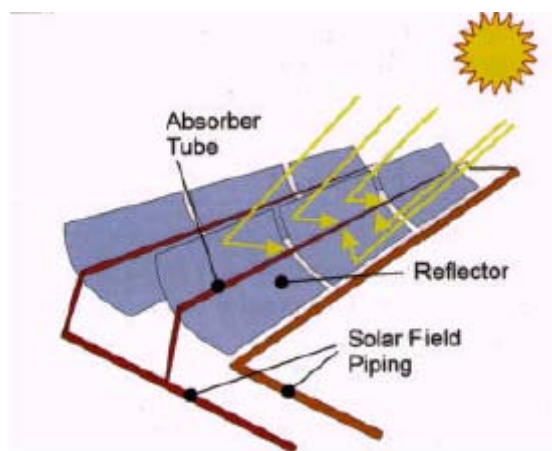

Figure 5-7: Solar Parabolic Trough Concept



Figure 5-8: View of rows of troughs at Mojave Desert, USA

5.3.2 Power Tower Systems

These use an array of heliostats (large individually-tracking mirrors) to focus sunlight onto a central receiver mounted on top of a tower (*Figure 5-9*). The largest power tower, Solar One (see *Figure 5-10*), which was built in Southern California and operated in the mid-1980s, used a water/steam system to generate 10 MWe.

In 1994, Solar One was retrofitted as a molten-salt receiver and diurnal storage system, Solar Two. The addition of this thermal storage capability makes power towers unique among solar technologies by promising dispatchable power at load factors of up to 65%. In Solar Two molten-salt is pumped from a “cold” tank at 288°C and cycled through the receiver where it is heated to 565°C and returned to a “hot” tank. The hot salt can then be used to generate electricity when needed. Current designs allow storage ranging from up to 13 hours. “Solar Two” first generated power in April 1996, and was run for a 3-year test, evaluation, and power production phase to demonstrate the molten-salt technology. A commercial unit is yet to be available. Net annual efficiency of 7% - 20% is estimated.

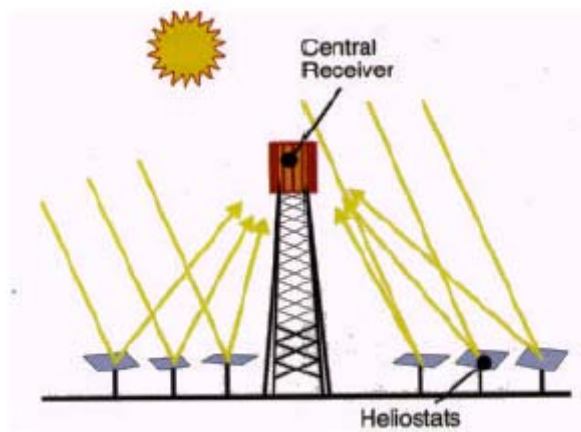

Figure 5-9: Solar Power Tower Concept



Figure 5-10: Solar One

5.3.3 Dish/Engine Systems

These use an array of parabolic dish-shaped mirrors (stretched membrane or flat glass facets) to focus solar energy onto a receiver located at the focal point of the dish (*Figure 5-11*). The concentrated radiation is used to operate a Stirling heat engine. Dish/engine systems, ranging in size from 7 to 25 kW are now available and larger systems are being developed. High optical efficiency and low start up losses make dish/engine systems the most efficient (29.4% record solar to electricity conversion) of all solar technologies. In addition, the modular design of dish/engine systems make them a good match for both remote power needs in the kilowatt range as well as hybrid end-of-the-line grid-connected utility applications in the megawatt range.

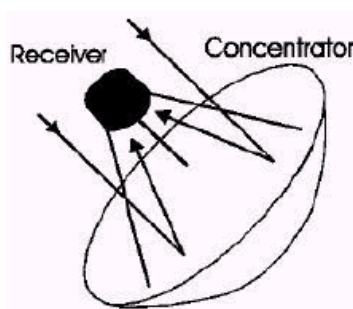

Figure 5-11: Solar Dish/Engine System Concept

5.3.4 Fresnel Concentrator

Scaling up of parabolic trough or dish collectors for large solar thermal power systems is limited by wind loading problems and shading between adjacent concentrators. The concept of large reflectors broken down into many sub-elements is called a Fresnel concentrator. A Fresnel system can be designed with a stationary absorber so that a high-pressure direct steam generating absorber does not need flexible couplings. The system can also be scaled up in size without increasing the aperture width of the mirror components. A large Fresnel system can be designed with only one absorber line for a collector aperture width of 50 m or more. However, as a Fresnel system is scaled up the spacing between the outer lines of mirrors must be increased to avoid shading (*Figure 5-12*). This is a problem for trough and dish systems as well.

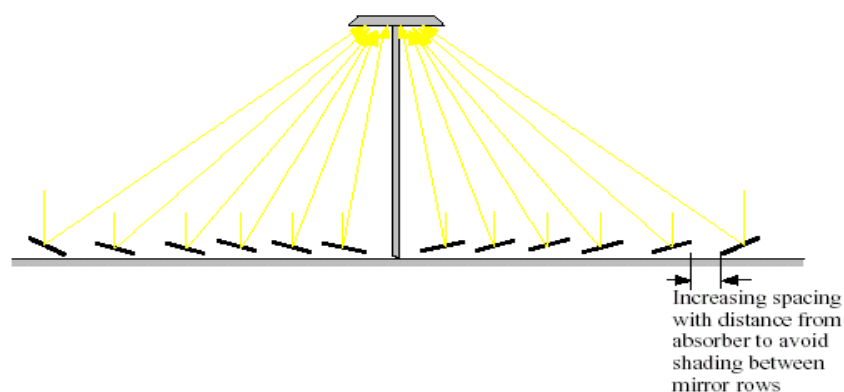

Figure 5-12: Fresnel Concentrator with Stationary Absorber

5.3.5 Discussion

Towers and troughs are best suited for large, grid-connected power projects in the 30 MW to 200 MW size, whereas, dish/engine systems are modular and can be used in single dish applications or grouped in dish farms to create larger multi-megawatt projects. Parabolic trough plant is the most “mature” solar power technology available today. Power towers, with low cost and efficient thermal storage, promise to offer dispatchable, high capacity factor, solar-only power plants in the near future. The modular nature of dishes will allow them to be used in smaller, high-value applications depending on technological advance.

Towers and dishes offer the opportunity to achieve higher solar-to-electric efficiencies and lower cost than parabolic trough plant, but uncertainty remains as to whether these technologies can achieve the necessary capital cost reductions and availability improvements. Power towers require the operability and maintainability of the molten-salt technology to be demonstrated and the development of low cost heliostats.

In comparison with solar PV technologies, which have typical system “solar-to-electric” efficiencies of around 11%, some solar thermal electric power systems could be attractive from an energy conversion efficiency point of view. However, solar thermal electric systems do require *significant* additional space for the concentrators, turbo-generator units, heat exchanger, thermal storage and their auxiliaries compared to PV systems. Solar thermal electric systems are most suitable where land space is not a constraint, as in the desert areas in California, USA where both land and solar resources are plentiful.

In Hong Kong, as discussed previously, concentrator technology (e.g., parabolic mirrors) is unlikely to be effective, where a large proportion of the solar radiation is diffuse rather than direct. This means that the efficiency of any concentrator solar thermal electric systems in Hong Kong is likely to be at the lower end of the quoted scale, making it less competitive compared with PV systems.

In summary, solar PV systems would appear to be more appropriate (as a technology for wide scale application in Hong Kong) than solar thermal electric, given the latter would require more land or space for systems of comparable capacities. Solar thermal electric technologies are not considered further in this Study, as they are not suitable for wide scale application in Hong Kong.

5.4 SOLAR WATER HEATING

5.4.1 Introduction

Besides electricity generation, water heating is the obvious choice for solar energy utilisation. The world market for solar water heaters expanded significantly during the 1990s and as a result there has been a substantial increase in range and quality of products now available. Solar water heater production is now a major industry in Australia, China, Germany, Greece, Israel and the USA.

Most solar water heating systems for buildings have two main parts: a *solar collector* and a *storage tank*. The most common collector is called a flat-plate collector. Mounted on the roof, it consists of a thin, flat, rectangular box with a transparent cover that faces the sun. Small tubes run through the box and carry the fluid – either water or other fluid, such as an

antifreeze solution – to be heated. The tubes are attached to an absorber plate, which is painted black to absorb the heat. As heat builds up in the collector, it heats the fluid passing through the tubes.

The storage tank then holds the hot liquid. It can be just a modified water heater, but it is usually larger and very well insulated. Systems that use fluids other than water usually heat the water by passing it through a coil of tubing in the tank, which is full of hot fluid.

Solar water heating systems can be either *active* or *passive*, but the most common are active systems. Active systems rely on pumps to move the liquid between the collector and the storage tank, while passive systems rely on gravity and the tendency for water to naturally circulate as it is heated.

5.4.2 Thermosyphon Systems

Thermosyphon circulation systems are the commonest packaged solar water heating configuration in warm climates. A thermosyphon system (*Figure 5-13*) relies on natural circulation of water between the collector and the tank or heat exchanger, and is therefore a passive system. To achieve circulation during the day and to limit reverse circulation at night, the tank must be above the collector. There are also techniques that allow the tank to be mounted level with the collector rather than above the collector. Thermosyphon systems can be designed with various levels of freeze protection, ranging from dump valves or heaters in the bottom collector header for mild freeze areas to inherent freeze resistance by using a natural circulation anti-freeze closed loop between the collector and the tank.



Figure 5-13: Close-coupled Thermosyphon System

5.4.3 Evacuated Tube Systems

Extensive development of evacuated tubes has led to the introduction of a range of evacuated tubular collectors (*Figure 5-14* and *Figure 5-15*) and evacuated integral water heaters. Vacuum insulated collectors and tanks range from the widely adopted flooded Dewar-tube collector systems in China to the high performance vacuum insulated collector/storage systems in Japan. Evacuated collector systems for air heating or with an air to water heat exchanger have also been demonstrated but have not achieved commercial development. The “wet-tube” concept, in which water is in contact with the glass tube, can only be used for low-pressure water heating systems, as the tubes cannot withstand more

than a few meters water pressure. Systems incorporating pressure tubing inside all-glass evacuated tubes are also in wide use.

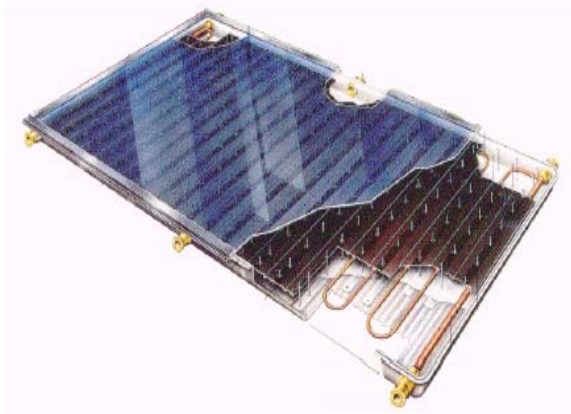

Figure 5-14: Flat Plate Evacuated Collector



Figure 5-15: Evacuated tube collector mounted on balcony of a high rise building

For commercial and high-rise building applications large solar water heaters can be constructed to provide centralised water heating systems. An example of a large evacuated tube solar collector array is shown in *Figure 5-16*.



Figure 5-16: Large scale evacuated tube solar collector array

The performance of the flat plate collector system is slightly (a few percent) higher than the evacuated tube system due to the very diffuse solar radiation conditions in Hong Kong. In diffuse conditions the concentrator used with each evacuated tube cannot collect as much of the radiation as a flat plate collector. Improvements in concentrator design for evacuated tubular collectors are expected to reduce the difference in the performance between the two

systems. Evacuated tube collectors have the added advantages of lightness, better weather resistance and ease of installation in high-rise buildings.

5.4.4 Discussion

As discussed in Chapter 2, the total hot water consumption in Hong Kong was equivalent to 10,245 TJ (or 2.85 TWh) in 1998. This is equivalent to about eight per cent of the SAR's total annual energy consumption. The majority of hot water consumption (over 82%) is by the domestic sector (i.e., residential buildings). Commercial, industrial and others are minor users of hot water in comparison. This suggests that focus of solar water heating application should be to domestic water heating, if significant energy benefits are to be achieved.

5.4.4.1 Technical Performance of Solar Water Heaters

Two solar water heater configurations could be used on individual apartments in Hong Kong:

- ❑ Flat plate solar water heaters; and
- ❑ Evacuated tube solar water heaters.

Depending on the hot water demand¹, these systems could be configured with 300 litre storage tanks and a 4-m² solar array or half size systems with 150 L tanks and 2-m² panel. The same solar water heater technology may be applied to hospitals, hotels, restaurants, and other hot water users. However, as the loads are much higher than for domestic heaters, a central hot water system with a hot water distribution loop around the building may be adopted. For this configuration a large solar array would be mounted on the roof of the building and around any service floors. Also, much larger storage tanks would be required.

The technical performance of a solar water heater depends on the water use load patterns (seasonal and daily) and the weather conditions. As part of this study, the TRNSYS (Klein et al. 2000) simulation model was used. The weather data used for this analysis was one year of hourly data for solar radiation, ambient temperature, and humidity.

The energy consumption of conventional electric and gas in-line water heaters commonly used in Hong Kong was evaluated for annual energy delivery of 36 MJ/day peak winter load. The same load conditions were applied to the solar systems. The solar water heaters were evaluated by a combination of measured collector efficiency, measured tank heat loss and typical residential load cycle patterns. The annual load cycle calculation accounts for typical daily and seasonal variations of hot water use and weather conditions.

The TRNSYS model found that a solar water heating installation with a 4 m² solar collector and water tank volume of 250 to 270 L could produce about 8,200 (12,200 to 4,000) MJ/yr of thermal energy. The solar insolation is 18,980 MJ/yr for the 4-m² collector, hence giving an efficiency of 43% for the solar water heating installation, taking into account of auxiliary power. Annual energy savings relative to use of conventional electric in-line water heater are predicted to be large, as shown in *Table 5-2*.

¹ As the solar water heating only occurs in the daytime, storage tank is normally used to store the heated-up water that would normally be consumed in high demand periods, mostly in the morning and in the evening.

Table 5-2: Energy Savings Relative To A Conventional In-Line Electric Water Heater

System	Annual energy savings (%)
Flat plate solar water heater (in-line booster)	74.4
Flat plate solar water heater (in-tank booster)	65.6
Evacuated tube solar water heater (in-line booster)	69.3
Evacuated tube solar water heater (in-tank booster)	62.3

These results indicate that solar water heaters work effectively in Hong Kong and that significant energy savings can be achieved. Systems with smaller water storage tanks and smaller solar collector arrays, for smaller apartments, would have slightly lower performance than the 250 litre system analysis in this study, as small tanks typically have higher loss per unit storage volume. Conversely, larger systems as that would be adopted in hospitals and hotels would be more efficient, as the storage tanks could be as large as 30,000 litres in these facilities.

5.4.4.2 Constraints to Adoption of Solar Water Heaters

It is noted that current practice for residential water heating in Hong Kong is to use instantaneous (or in-line) gas and 3-phase electric heaters. This means that there is no hot water storage tank and hence a solar water heater will be difficult to retrofit to existing buildings. The ideal solar water heater is a solar pre-heater (storage tank with solar panel but no in-tank gas or electric boosting) followed by an in-line² gas or electric booster.

Retro-fitting of solar water heaters to existing residential buildings in Hong Kong would be difficult due to space requirements for the solar hot water tank. It is possible to mount solar collectors on a south-facing wall of high-rise building or on balconies. Integration of solar collectors into a building at design stage is relatively straightforward. A typical architectural design approach for high-rise buildings is to build the solar collector into a window shade. An alternative approach is to use a central hot water system with a hot water distribution loop around the building. For this configuration a large solar array would be mounted on the roof of the building.

For large commercial or institutional users such as hospitals and hotels, opportunities for installation of solar water heaters could be more, as there would be relatively more space to retrofit such systems. This, however, will need to be evaluated on a site-specific basis.

5.4.4.3 Conclusions

Given the significant energy savings, solar water heating should be promoted in Hong Kong. However, it is noted that water heating only accounts for a very small proportion (8%) of the SAR's total energy consumption. The majority (82%) of hot water use is by the domestic sector, where there are significant space constraints to installation or retrofitting of hot water storage tanks. This means that the opportunities for solar water heating would be for specific uses such as hotels, hospitals, sports centres, etc., where a centralised water

² A special form of in-line heater is required for use with a solar water heater, as the inlet temperature to the instantaneous heater will vary with solar radiation conditions. Most in-line heaters do not have an inlet temperature sensor and hence are not able to modulate the gas flow rate or electric power of the in-line heater in response to inlet temperature changes.

heating and storage system might be more practicable. Solar water heating application would therefore be more appropriately regarded as site-specific rather than territory wide.

5.5 SOLAR TECHNOLOGY FOR WIDE SCALE APPLICATION

Hong Kong has a significant solar energy resource, with an annual average of 1.29 MWh/m² (4.66 GJ/m²) global horizontal radiation.

Both solar PV and solar thermal power technologies produce electricity. However, it would appear the potential for wide-scale application of solar PV systems would be higher than thermal electric in Hong Kong, given the latter would require more land or space for systems of comparable capacities. Solar PV systems, in particular BIPV, are particularly suitable for the dense urban environment of Hong Kong, where land is precious and demand for electricity high. PV systems are unobtrusive and silent in operation and can be mounted on buildings or elsewhere, using space that is already alienated. Its energy output profile as a function of time is similar to the electrical load profile, allowing it to provide high-value peaking power. The modules can be located very close to loads, thus avoiding transmission losses and electricity distribution infrastructure costs. However, this is not to say solar thermal electric power systems should not be considered at all. There may or may not be opportunities for adoption of this technology at existing or planned power station sites, and this is best investigated by others (e.g., power station operators) outside the current study.

Another method of utilising solar energy in Hong Kong is solar water heating. While this technology does not produce electricity, it could reduce electricity (and gas) consumption and indirectly conserve fossil fuels. However, the opportunities for solar water heating would be predominantly for specific uses such as hotels, hospitals, sports centres, etc., where a centralised water heating and storage system might be more practicable. Solar water heating application would therefore be more appropriately regarded as site-specific rather than territory wide.

In conclusion, it is suggested that solar thermal power generation and solar water heating should be pursued outside the current Study. Solar PV systems are further evaluated in the following sections.

5.6 IDENTIFICATION OF PV DEPLOYMENT OPTIONS

Hong Kong has a total land area of 1,098 km². However, the area that is actually available for PV panel installation would be smaller due to many other land uses and constraints. This is illustrated in Chapter 2, which shows that a significant proportion of the land (815 km²) is for open space, woodlands, grass, and shrubs. Of this, about 415 km² are designated country parks and special areas.

Built-up or developed areas (including commercial, residential, housing, industrial, institutional, community, roads, railways, etc), where demand for power is highest, are concentrated in an area of about 167 km². Within these very densely populated and highly urbanised areas, there are many high-rise (typically 30 to 40 storeys) residential and commercial buildings consuming a significant amount of energy. An understanding of these unique features of Hong Kong's land use pattern and built environment is necessary to

formulate deployment options for PV systems and hence to estimate the practical resource potential of this renewable energy system.

In general, applications of solar PV systems may be grouped into the following categories:

5.6.1 Building Integrated Photovoltaics (BIPV)

In a BIPV system, PV panels or arrays are mounted on or fully integrated into the roofs, facades, and walls of residential, commercial, institutional, or industrial buildings. BIPV uses previously alienated space for an additional purpose. It also reduces transmission losses and cable expense through proximity to the load.

The PV system may be grid-connected or in a stand-alone mode, though the PV arrays are interconnected to the building's power distribution system in either case. However, stand-alone BIPV systems are not connected to the utility grid. They generally need to include an energy storage device to temporally match the supply to the load. This often takes the form of an electrical storage battery. An inverter is required if AC loads are to be supplied and a charge regulator is needed to prevent overcharging and excessive discharging of batteries. Stand-alone systems often include backup energy sources, which may be conventional diesel generators or other renewable energy systems.

5.6.2 Non-BIPV systems

These are those PV power generation systems installed in areas other than building type structures. These could include, for example, highway noise barriers, roadside slopes, bus shelters, and possibly open space areas. These systems are likely to be further away from the load compared to BIPV systems. Again, they may be grid connected or in a stand-alone mode.

5.7 PV RESOURCE ESTIMATION

In assessing potential for deployment of PV systems, a fundamental issue is the allowable space for system installation. It is recognised that this is a very site-specific consideration, as the system may be located in different geographical settings, resulting in different efficiencies in sunlight capture. Also, PV panels may be installed in different configurations, e.g., horizontally, vertically, or tilted. All these factors affect the electrical energy that can be generated from the PV systems.

To assist in resource estimation, "*equivalent horizontal areas*" that may be utilized for PV array installation for each land use category has been assumed, as shown in *Table 5-3*. Based on these assumptions, the practical resource (electricity generation) for each land use category was then calculated. *Table 5-3* is therefore an indication of the priority areas for PV deployment in terms of practical resource potential, which may be refined in the future by adjusting the assumed utilization ratios.

Table 5-3: Assumed PV Deployment Rates and Estimated Potential³ Resource

Land Use	Area (km ²)	Assumed Effective Horizontal PV Surface Ratio	Equivalent Horizontal Area for PV Power Generation (km ²)	Potential Resource (GWh)
BIPV System Deployment				
Residential	45	30%	13.5	1,629
Public rental housing	14	30%	4.2	507
Commercial	2	50%	1.0	121
Industrial	11	50%	5.5	664
Government, institution and community facilities	21	20%	4.2	507
Temporary housing areas	1	0%	0.0	0
Vacant development land	27	60%	16.2	1,955
Non- BIPV System Deployment				
Roads/Railways	33	5%	1.7	199
Airport	13	10%	1.3	157
Open Space	17	10%	1.7	205
Woodlands	220	0%	0.0	0
Grass and shrubs	519	0%	0.0	0
Badlands, swamp and mangrove	44	0%	0.0	0
Arable	59	0%	0.0	0
Fish ponds	14	0%	0.0	0
Temporary structures/livestock farms	11	0%	0.0	0
Reservoir	26	0%	0.0	0
Other uses	21	0%	0	0
Total	1,098		51	5,944

Referring to *Table 5-3*, the potential for **BIPV** deployment is summarised as follows:

- ❑ *Residential (including public rental housing).* Assuming that an equivalent of 30% of horizontal residential land area could be utilised to install PV arrays, a total of 2,136 GWh of electricity would be generated annually. This is equivalent to about 6% of Hong Kong's annual electricity demand in 1999. It is noted that the power demand of residential buildings is low at daytime during weekdays, so there could be excess PV power that can be fed to the grid for use at other high load areas (such as commercial buildings).
- ❑ *Commercial.* It has been estimated that commercial BIPV potential is around 121 GWh/yr, or 0.3% of the 1999 annual electricity demand. This result indicates that the BIPV systems in commercial buildings contribute a relatively small portion of total PV generation potential. However, it is sensible to adopt BIPV power generation in commercial buildings, where most of energy produced would be consumed internally during daytime working hours. In comparison with residential, G/IC and other land uses, commercial buildings have been assumed to have a higher rate of PV installation

³ "Potential Resource" is as defined in 3.2.

(50%), due to the less open space area within commercial lots.

- ❑ *Government, institutional and community (G/IC) facilities.* G/IC facilities mainly are government offices, community centres, health care facilities, educational institutions, etc., and these types of buildings normally have comparatively large open space area. So the assumed effective PV installation factor for G/IC type BIPV was set at 20%. With this assumption, the annual electrical energy generation from G/IC buildings is 507 GWh, or 1.4% of the 1999 annual electricity consumption.
- ❑ *Industrial.* As with commercial buildings, an effective PV installation factor of 50% is our initial estimate for industrial building BIPV systems. This could generate 664 GWh/yr, or 1.9% of the 1999 annual demand for Hong Kong.
- ❑ *Vacant Development Land.* This large reserve of vacant land (27 km²) presents an excellent opportunity for deployment of PV systems. Here, BIPV (or non-BIPV) systems may be “designed into” the future developments, allowing significant (and also potentially cost-effective) utilisation of solar energy systems. If an effective PV installation factor of 60% were achieved, some 1,955 GWh of electricity may be generated, which is equivalent to 5.5% of the SAR’s annual electricity demand in 1999.

Opportunities for installation of **non-BIPV** systems, in either grid-connected or stand-alone mode, include:

- ❑ *Open space.* This is reserved for passive or active recreation e.g., parks and gardens, football pitches, etc. If 10% of open space (e.g., as roof-mounted PV on shelters and features) could be used for PV module installation, 205 GWh of electricity would be generated, which is equivalent to 0.6% of the SAR’s annual demand in 1999.
- ❑ *Roads/Railways.* Highway and railway acoustical barriers and enclosures, and slopes on the sides of roads or highways are the prime candidates where non-BIPV systems could be installed. Bus-shelters, and covered walkways or footbridges also present opportunities for PV installation. Assuming that 5% of roads/railways area could be utilised for PV arrays installation, 199 GWh of electric output (0.6% of the 1999 annual demand) would be generated.
- ❑ *Airport.* Located in a well-exposed area, the airport site is potentially an excellent area for PV installation. The airport terminal and its associated facilities, as well as un-utilised land along the runways could potentially be installed with PV modules. For this assessment, a maximum area of 1.3 km² may be available for PV arrays installation, and this could generate 157 GWh of electricity annually (or 0.4% of the 1999 annual electricity demand).
- ❑ *Grassland, woodland, farmland, swamp, fishpond, reservoir, including country parks and special areas* occupy over 815 km² of land. It has been assumed that no large-scale grid-connected PV systems would be deployed at these locations. Apart from potential environmental and conservation constraints, these areas are remote from load centres, making it lesser of a priority for distributed power generation. There may be opportunities for stand-alone small-scale applications (such as solar-powered telephone booths in country parks, for instance), but this would not be for wide-scale community adoption.

5.8 REVIEW OF ENVIRONMENTAL ISSUES

BIPV and non-BIPV systems would be most preferable NRE options from an environmental standpoint as the systems emit no gaseous or liquid pollutants, no radioactive substances, and no noise. They are superior in most of the environmental aspects, with the exception of “visual implications” given these systems would be highly visible in urban areas. Aesthetic considerations are of more importance for vertical BIPV applications, but this may be regarded as either attractive or unattractive according to aesthetic tastes.

5.9 PRELIMINARY ESTIMATES OF GENERATION COST

“Levelised Cost of Electricity” (LCE) is a parameter that is commonly used to compare the cost of alternative power generation systems. LCE adopts a life cycle cost approach and uses net present value calculations as a means of comparing the average unit cost of electricity between alternatives, which may differ significantly in their relationship between “capital” and “operation & maintenance” (O&M) costs.

To calculate LCE, the annual capital cost and O&M cost are calculated for each year over the life of the generation system. The resulting series of annual cost stream is discounted using a discount rate to produce discounted capital and O&M expenditure each year, then summed to a total net present cost. This is in turn divided by the sum of annual energy output to yield the LCE in terms of \$/kWh.

A LCE was calculated for both BIPV and non-BIPV options. *Appendix A* contains the cost models that were developed to estimate the LCE for each options, including the assumed deployment scenarios, equipment price drop trends, breakdown of raw cost data, as well as a comprehensive sensitivity analysis. It should be noted that land costs are excluded from all LCE calculations.

The cost of energy from PV installations is dependent on many varying parameters, with the most important overall variables being the project capital cost and long-term energy yield. The magnitude of the effect on changes of parameters in BIPV and non-BIPV was investigated by undertaking a series of sensitivity analyses. The results indicate that the cost of generation is at between \$2.2/kWh and \$4.1/kWh.

5.10 IMPLEMENTATION ISSUES

5.10.1 Building and Construction Issues

The Buildings Department (BD) controls all private development in Hong Kong under the Buildings Ordinance and allied legislation. Any person who intends to carry out building works is required by law to appoint an authorized person, and where necessary a registered structural engineer, to prepare and submit plans for the approval of the Building Authority under the Buildings Ordinance. They are also required to appoint a registered contractor to carry out the building works.

Authorized persons, registered structural engineers and registered contractors have statutory responsibilities for supervising and carrying out building works and submitting stability certificates and test reports. When breach of statutory provisions is identified, the

Building Authority may order works to cease or to be remedied. Offenders are also liable to prosecution or disciplinary proceedings.

The Building Department will check plans for compliance with the law, and refer them to other relevant Government departments for examination in their areas of concern. This centralised proceeding system ensures that all statutory technical standards, safety standards and other requirements under the law are met.

Any building-integrated new or renewable energy installations (PV for example) would have to comply with the codes of practice and standards in order for approval of the building plans to be obtained. The specific standards concerning PV include those on wind effects, cladding and curtain wall systems requirements. The Building Innovation Unit assists innovative and unusual development proposals (such as large solar panels on the roof) to obtain approval. Short circuits in PV panels are not easily detected, and fire retardant cables are required. The Fire Safety Ordinance applies.

Before work starts, consent to commence building works is required from the Building Authority, and the Building Department will monitor sites where work is in progress and inspect sites regularly, particularly at critical stages for safety assurance and for compliance with statutory requirements under law. The Building Department also makes final checks before issuing an occupation permit.

5.11 CONCLUSIONS

It has been found that solar PV technologies are potentially suitable for wide scale application in Hong Kong, given abundant solar resource and the dense nature of our urban built environment. On the other hand, solar thermal power (electricity) generation and solar water heating could be pursued as site-specific applications on a case-by-case basis.

The *potential resource* of PV power in Hong Kong has been estimated at 5,944 GWh/yr. It is equivalent to about 17% of the SAR's annual electricity consumption in 1999. Therefore, if realized, this would be quite a significant source of renewable energy.

6 WIND ENERGY

6.1 WIND ENERGY BASIC

Wind is the results of expansion and convection of air as solar radiation is absorbed on the earth. On a global scale, these thermal effects combine with dynamic effects from the earth's rotation produce the prevailing wind patterns. Apart from this behaviour of the atmosphere, geographical and environmental factors can cause the variation.

Wind turbines are devices which convert the kinetic energy of the wind into rotational motion to turn an electrical generator and produce power. This is done by means of a rotor which is comprised of blades with an aerodynamic profile, which transmits the rotational motion via a drive train to the generator. Various types of ancillary equipment may be required to perform such tasks as orienting the rotor into the wind, controlling the electrical qualities of the power output, and ensuring safe operation of the turbine within its design parameters.

Since the kinetic energy available in the wind is proportional to the cube of the wind speed, the amount energy which can be captured by any given wind turbine is very sensitive to the wind speed encountered at the location in which it is installed. The average wind speed encountered at any given location may vary depending on both the overall meteorological conditions in the general area, and also on local topographic factors such as wind flow over hills and the effect of surface roughness elements such as trees and buildings. For these reasons, evaluation of the wind conditions at a potential wind turbine site is critical in detailed design of any wind turbine systems.

6.2 WIND TURBINE TECHNOLOGY

Considerable diversity both of design concepts and system details is evident in present commercial wind turbines. Until recently the market has been dominated by the "Danish" concept of three bladed stall regulated fixed speed machines. However, there are increasing departures from this design concept, especially for megawatt-scale turbines.

Manufacturers are also increasingly adapting their designs to offer machine variants specifically targeted for different types of site. For example, Vestas used to supply their 600 kW turbine with three different rotor diameters; 39 m, 42 m and 44 m. A range of tower heights is also available from most manufacturers in order to optimise the energy yield from the site.

Some of the most significant design and technology issues are described in the following sections.

6.2.1 Horizontal versus Vertical axis

One fundamental design decision is the orientation of the shaft about which the aerofoil blades are configured to generate torque. The vertical axis design concept is now commercially sidelined, with no machine suppliers offering a commercial model. This is due to the conceptual benefits of the vertical axis design (i.e., it is omni-directional) being difficult to realise in practice due to other constraints (e.g., energy at greater height not recovered,

limited tower height due to need for guy wires, etc). *Figure 6-1* and *Figure 6-2* show a vertical and a horizontal axis wind turbine respectively.



Figure 6-1: Vertical axis wind turbine
(Source: NREL, US DOE)



Figure 6-2: Horizontal axis wind turbine
(Source: NREL, US DOE)

6.2.2 Upwind versus Downwind Rotor

The distinction between up-wind and down-wind machines applies to horizontal axis turbines only. This design issue refers to the relative orientation of the rotor (wind turbine blades) relative to the tower (supporting structure). Some of the advantages and disadvantages of the competing concepts are outlined in *Table 6-1*. The majority of modern large wind turbines are up-wind machines.

Table 6-1: Up-Wind versus Down-Wind Characteristics

Up-wind rotor	Down-wind Rotor
Reduced tower shadow effect	Significant tower shadow effect
Less noise	Noisy due to greater tower shadow effects on blades
Rotor thrust offsets weight overhung load	Rotor thrust adds to overhung load
Blade tower clearance can be a problem	No problem with blade-tower clearance
An active yaw drive is usually required	Free yaw is much more feasible

6.2.3 One, Two, Three or More Blades

There is ongoing debate whether one, two or three blades are optimum. There is a consensus that no more than three are required, except where the turbine requires a high starting torque (e.g. applications such as direct mechanical water pumping).

Some of the issues involved in the debate are aerodynamic efficiency, complexity, cost, noise and aesthetics. Often these issues involve trading off advantages and disadvantages. For example, a single bladed rotor is cheaper to manufacture, but requires a counter weight to balance the rotor and consequently there is no tower top weight saving over a two-bladed turbine.

Also, a two-bladed teetered rotor allows an efficient blade/hub structure, and the teetering alleviates dynamic loads on blades and tower top significantly. However, design of the teeter hinge system is often a major concern, and the benefits of teetering in reducing fatigue loads are often offset by the effect of impacts on teeter stops in transient (start up/shut down) or extreme operating states.

One very significant issue is that public opinion surveys suggest that a greater proportion of people perceive three-bladed turbines as being more balanced and aesthetically pleasing. A two-bladed rotor gives the appearance of changing speed as the blades pass the tower. Also a stationary three-bladed turbine will always appear more balanced than a two or one-bladed turbine.

An aesthetic preference for three-bladed wind turbines amongst European planners has caused several manufacturers of two bladed wind turbines to reconsider their design. For example the turbine manufacturers Lagerwey, Nedwind, WindMaster and WEG moved from two to three-bladed designs a few years ago.

6.2.4 Active Aerodynamic Control And Stall Regulation

All turbines produce a varying power output dependent on the wind speed. Since the power of the wind increases in proportion to the cube of the wind speed, available power increases rapidly. Since wind turbine costs increase proportionately with the rated turbine capacity, and because the higher wind speeds occur less frequently, it is uneconomic to install power conversion capacity in a wind turbine above a certain limit. A useful rule of thumb is to rate a wind turbine at a wind speed of 1.5 times the site annual mean wind speed.

The limit imposed on the power conversion capacity of the wind turbine requires a means of achieving power limiting in high winds. There are various means for doing this. The two most common are “stall regulation” and “pitch regulation”.

With stall regulation, an increase in wind speed beyond the rated wind speed causes progressive stalling of the air flow over the rotor. The key to stall regulation is to maintain a constant rotor speed, which is commonly achieved by means of an induction generator connected to a relatively strong electric grid. Aerodynamic brakes on the rotor or mechanical brakes are required in case the generator reaction torque is lost.

Pitch-regulated turbines are those that have the ability for the blades to continuously change pitch (the angle of the aerofoil section) in accordance with the wind speed. The aerodynamic performance of the rotor is therefore altered (reduced) by changing the rotor geometry. This also allows feathering which can reduce the extreme loads occurring in conditions beyond the cut-out (maximum operating) wind speed. However, the pitching blade is dependent on its actuators and control system and, in turbulent wind conditions, is always at risk of being caught in the wrong position, in which case it can develop much higher (or lower) loads than a stall regulated blade.

A number of other types of power regulation are possible, including partial span control and aileron control.

6.2.5 Fixed, Variable or Partial Variable Speed

Fixed speed operation has been very common because of its simplicity; the generator directly produces alternating current at grid frequency. As wind speed increases, the rotor delivers increased torque which translates to higher current output. The ability to maintain fixed speed relies on the generator characteristics.

Variable speed operation allows an increased rotor aerodynamic efficiency, since the flow geometry over the rotor is more constant and the rotor can be optimised for maximum efficiency in that flow state. In principle this leads to increased energy capture and additional benefits such as lower noise in light winds (when turbine noise may be most obtrusive), and lower peak drive train loads.

However, operation of a generator at variable rotational speed to produce a fixed output frequency requires additional complexity and electrical equipment cost. This additional power conditioning equipment may offer some additional benefits, such as the ability to supply reactive power to the grid.

A number of compromise systems have been developed to exploit some of the benefits of variable speed operation. For example two speed systems have been extremely popular as a compromise. At lower wind speeds the turbine switches to a different generator for a lower blade tip speed and therefore lower noise levels. Higher generator efficiencies than variable speed are claimed. It appears that in practice, a dual speed turbine has a very similar efficiency to that of a variable speed machine and that there is no gain in energy output in moving to variable speed.

One supplier (Vestas 'Opti-Slip') also employs partial variable speed drive by inserting resistance into the rotor circuit of the generator to increase slip at full power, and hence allow the rotor to vary in speed when at maximum rated power. This variable slip drive allows a $\pm 10\%$ rotor speed variation at full power. This allows some of the benefits of variable speed without the cost of power conditioning.

6.2.6 Tower options

Wind turbine tower options include tubular or lattice designs, with tubular towers becoming more popular. Spun concrete towers are also in use. The choice of tower type is driven largely by aesthetics and cost. Historically, the most significant design issue has been the stiffness requirements of the tower;

- ❑ *Stiff Tower* - resonant frequency of tower is higher than blade passing frequency - turbine operates below tower resonant frequency.
- ❑ *Soft Tower* - resonant frequency of the tower is between the rotor rotational frequency and the blade passing frequency - rotor rotational frequency is below the tower resonant frequency while the blade passing frequency is higher than the tower resonant frequency

- ❑ *Soft-soft Tower* - resonant frequency of the tower is lower than the rotor rotational frequency - turbine operates at frequencies higher than the tower resonance.

In general, stiff towers employ more steel than soft towers and thus tend to be more expensive. No commercial machines now use stiff towers.

6.2.7 Other Wind Turbine Design Issues

The components of a wind turbine are subject to highly irregular loading due to the turbulent wind environment in which they operate. For example, the fatigue induced by turbulent wind loading is much more acute for a wind turbine than for an aircraft. The principal resonant frequencies of a wind turbine are often within the same narrow bandwidth as the main forcing frequencies of wind loading. Also, the number of fatigue load cycles experienced by a wind turbine is typically more than two orders of magnitude greater than that for other rotating machines.

A major trend which has been established over the last five years is a dramatic increase in machine size. The sudden increase in capacity from about 500 to 1,500 kW was largely driven by the European Commission who were keen to encourage utility size machines. However, larger turbines are also required for the offshore (sea bed sites) market which is of increasing interest due to land availability and planning issues in many parts of the world. Off-shore developments where foundation costs are a significant part of overall project costs, are suited to the larger turbines.

Transport and erection of these megawatt-scale turbines is a significant constraint, since road transport infrastructure in many countries will limit the movement of these turbines.

6.2.8 Modern Trends in Wind Turbine Technology

A wide range of wind turbine concepts has been explored and many different approaches are presently used by commercial manufacturers. However, some clear trends are discernible:

Some matters have been settled – there is no longer any serious consideration of vertical axis machines, and also there is a move away from two-bladed rotors for use in populated areas.

Variable speed has also been gaining ground over fixed and two speed concepts. This has been driven primarily for improved grid connection qualities and noise reduction rather than improvements in energy yield. All the major manufacturers offer, or are developing, variable speed designs.

Another notable development is the use of purpose-built multi-pole direct drive generators. The use of such generators avoids the need for step-up gearing and drive-train components, potentially giving fewer moving parts for maintenance, a reduction in mechanical losses, greater reliability and lower tower head weight. This concept has been championed by the German manufacturer Enercon. Due to the higher mass of multiple pole generators, it is presently unclear if the direct drive system is lighter or cheaper overall.

There is also a risk that should the generator fail, the whole nacelle may need to be replaced. The turbine generator/nacelle becomes more of a specialist component rather than the more modular nature of the more traditional drive train configuration.

Flexible wind turbine designs are also still being explored. Some other emerging and as yet unproven technologies are described in the next section.

6.2.9 Wind Turbine State of the Art

6.2.9.1 Large Wind Turbines

The horizontal axis, upwind rotor, 3-bladed turbine on a free-standing tubular or lattice tower remains the predominant configuration for large grid-connected wind turbines.

The typical size of wind turbines has grown steadily in terms of rotor diameter and rated power over the past 20 years. For the past five years, the most cost-effective size range has been 600-750 kW with rotor diameter in the range 40 to 47 m. These turbines have been manufactured in substantial numbers by all manufacturers and are the baseline technology from which a new generation of megawatt-scale turbines have been recently developed.

In the past three years, many manufacturers have started producing megawatt-scale turbines with rated powers of 1.0 to 2.0 MW, primarily for the European market where good sites are at a premium and there is much pressure to make the most of them. Given the limited track record of megawatt-scale turbines at sites with complex wind conditions, their use should be considered very carefully in relation to the site characteristics.

Considerable diversity both of design concepts and system details is evident in present commercial wind turbines. Manufacturers are also increasingly adapting their designs to offer machine variants specifically targeted for different types of site. For example, Vestas supply their 600 kW turbine with three different rotor diameters; 39 m, 42 m and 44 m. A range of tower heights is also available from most manufacturers in order to optimise the energy yield from the site.

6.2.9.2 Small Wind Turbines

A distinct category can be defined as small machines, with a rated power in the range of a few Watts to a few tens of kW. These machines are generally intended either for battery charging to meet small loads remote from a grid supply or, at the larger end of the range, for connection directly into a distribution grid. These may feed directly into a local grid (providing the utility benefits of distributed generation), or directly to a specific consumer load group (offsetting delivered electricity at a retail price). Due to their small size, these machines generally produce power at a higher unit cost than electricity from large (several hundred kW and up) machines utilised in wind farms. Generally speaking, for small projects, the cost of addressing the other issues involved in any wind power development such as visual intrusion, noise, safety, etc. will be proportionately greater relative to the output.

There are a small number of examples of such machines being installed in urban environments, mostly as research and demonstration projects. Installing machines on top of commercial buildings has the advantages of exposing the wind turbines to higher average wind speeds (at the higher elevation), and also being able to supply the building electrical load to avoid retail electricity prices. However, it also introduces additional issues of structural loading and public safety. The size of machine which could be used on top of a building is relatively small in order to maintain the design integrity of the building itself.

6.3 OPTIONS FOR WIDE-SCALE DEPLOYMENT

There are two principal types of wind farms: the land based wind farms, and marine based wind farms.

6.3.1 Land Based Wind Energy Systems

Land based wind energy systems may be either individual machines, or multiple machines arranged as a 'wind farm' which are generally a group of wind turbines, working collectively to harvest energy. Wind farm layout can be either a geometric array arrangement (where a large flat area is available), or a linear arrangement. Large-scale wind turbines are currently rated at 1 to 2 MW in capacity.

As described earlier, a typical 1 MW machine has a rotor diameter of approximately 60 m with a hub height of 50 – 70 m. In wind farm applications, wind turbines are typically spaced a distance of 8 times the machine diameter, centre to centre. This may vary depending on wind conditions. The tower would normally allow for approximately half a rotor diameter of clearance from the ground level. The foundation footprint of the turbine is not large in total area, but required substantial mass for stability.

6.3.1.1 Wind Farms

Where a large "flat" area of land is available, wind farms may be installed in the form of regular geometric arrays. The majority of the land in Hong Kong is hilly to mountainous, with the exception of the flat coastal areas and further inland in the Northwest New Territories area, which are highly urbanised or developed. Siting of a large wind farm in a *geometric* array is therefore unlikely to be viable on land in Hong Kong.

The more typical layout for wind farms is a *linear* arrangement (see *Figure 6-3*), in which the wind turbines are arranged along the ridge tops in hilly topography. Given the local topography (hilly terrain), and the high density of developments in the flat low lying areas, this is the type of layout most likely for Hong Kong. It should be noted that high wind resource areas in Hong Kong are predominantly on high ground.

Due to the higher wind power densities in and around the areas of the ridges of hills and mountains and the modest land area required for the footprint of the wind turbines, land-based wind farms are theoretically feasible. However, there are also many considerations that must be addressed before this option can be realised. As most hills are in country park areas, development and construction may be issues. Road infrastructure to facilitate transport up to the ridge areas does not currently exist, and construction of the wind turbine foundations, transporting and erecting the turbines may not be possible unless vehicular access is provided through the conservation areas.

It is usual to observe a minimum separation of the wind turbines from public roads and private housing, based on local planning constraints and noise issues. There are also the visual impacts to consider, as the siting of a wind farm will change the visual landscape of the area.



Figure 6-3: Land-based Wind Farm (Linear Arrangement)

6.3.1.2 Individual Machines

Individual wind turbines may be sited in either rural or urban areas. The wind turbine may be free standing on a tower. In urban areas it is also possible that small machines may be installed on the rooftops of high-rise buildings, although there are many technical and safety issues that would have to be resolved. This option may cause concerns over structural stability of the building, with the added load of the wind turbine and plant on the roof. There is also a visual impact, which may conflict with the existing architecture of the buildings, unless the building is a new building, with the wind turbine integrated into the design of the building. Impacts to the occupants of the building are in the form of noise and vibration. This option does, however, provide an easy connection to the utility grid, and does not involve extensive power transmission infrastructure.

6.3.2 Marine Based Wind Energy Systems

6.3.2.1 Near Shore Wind Farms

The near shore wind farm option is where wind farms are built near shore along the coastline of Hong Kong, in the shallow waters, founded on piles or other support structures for each individual wind turbine in the farm. These wind farms would require submarine cabling to transmit the energy to shore for connection to the transmission grid. The baseline conditions that can affect the siting and which must be addressed or avoided are; locations of fish culture zones, which are close to the shore, areas near beaches, and seabed utilities. There is also a visual impact to consider for near shore wind farms.



Figure 6-4: Near Shore Wind Farms

6.3.2.2 Offshore Wind Farms

Offshore wind farm is defined here as those built on artificial islands. Offshore wind farms have the additional costs of the extensive submarine cables for the transmission of power. There are a few constraints to siting of offshore wind farms, such as, avoiding commercial mariculture areas, shipping channels, seabed utilities, and areas of marine borrow and disposal. If the wind farm is located on an artificial island, the required grid connection may encourage commercial and/or industrial development on the island.

6.3.3 Summary

It is indicated that for wind energy technology, the option of rural area wind farms in a geometric array arrangement is unlikely to be feasible for Hong Kong, due to lack of suitable sized undeveloped flat land for an array of appreciable capacity. The option for rural area wind farms in a linear arrangement on mountain ridges may be considered, provided that constraints with respect to siting and access can be overcome.

Individual machines in urban areas, has several design issues which must be addressed prior to proceeding, such as safety, building stability, foundation stability, noise and vibration impact.

Near-shore wind farms and offshore wind farms are recommended for site specific evaluation, provided that the baseline constraint issues, such as avoidance of beaches, fish culture zones, seabed utilities and marine shipping channels, are addressed.

6.4 RESOURCE ASSESSMENT

6.4.1 Wind Resource Modelling

6.4.1.1 Meteorological Data

Standard practice when assessing the long-term wind climate at a prospective site is to first identify a reference meteorological station for which detailed and long term data is available. This station must have high quality anemometry and data logging equipment, and be located

at a well-exposed position representative of the general wind climate of the region. A high mounting height above ground level is also desirable, to avoid the influence of local topographic and surface roughness effects.

The meteorological station in the Hong Kong region which best meets these requirements is that on Waglan Island, a small island to the South West of Hong Kong Island. Waglan Island is well exposed geographically and not directly affected by urbanisation. The anemometer is mounted on a 26.3 m mast on ground at an elevation of 55.8 m, giving an effective monitoring height of 82.1 m above mean sea level. Information regarding the instrument installation has been supplied by the Hong Kong Observatory, in addition to long-term time series data on wind speed and wind direction.

The location, exposure, mounting height, instrument quality, and the length and consistency of the data record, make the Waglan Island meteorological station an excellent source of reference data for wind flow over the Hong Kong region. This suggests that the predicted long-term mean wind speed at the island is 6.9 m/s at 26.3 m above ground level.

6.4.1.2 Mathematical Modelling

To calculate the variation of mean wind speed over the area of Hong Kong, the computer wind flow model WAsP has been used. One of the inputs to the model is a digitised map of the topography and surface roughness length of the terrain for the area of interest and its surroundings.

The WAsP model predicts wind speed at a number of given points in the model domain, specified by Easting, Northing and height. The model was set to predict wind speeds at regular intervals on a 250 m grid over the area of the topographical model, and at a height of 65 m above ground level. This height was chosen because it is representative of the hub height of a modern, MW class wind turbine.

Figure 6-5 shows the model output in the form of an "isovent" map, showing lines of equal power density in terms of energy per unit area (W/m^2). This Figure has been generated by interpolation between the grid points at which wind speed has been estimated. This represents the integral value of all the wind energy passing through each unit area of rotor sweep, which is the area perpendicular to the wind, of a hypothetical wind turbine at that location. It should be noted that not all of this energy can be extracted due to theoretical and practical limitations on wind turbine operation. Modern wind turbines can extract up to a peak value of 40 to 45% of this energy at any given wind speed.

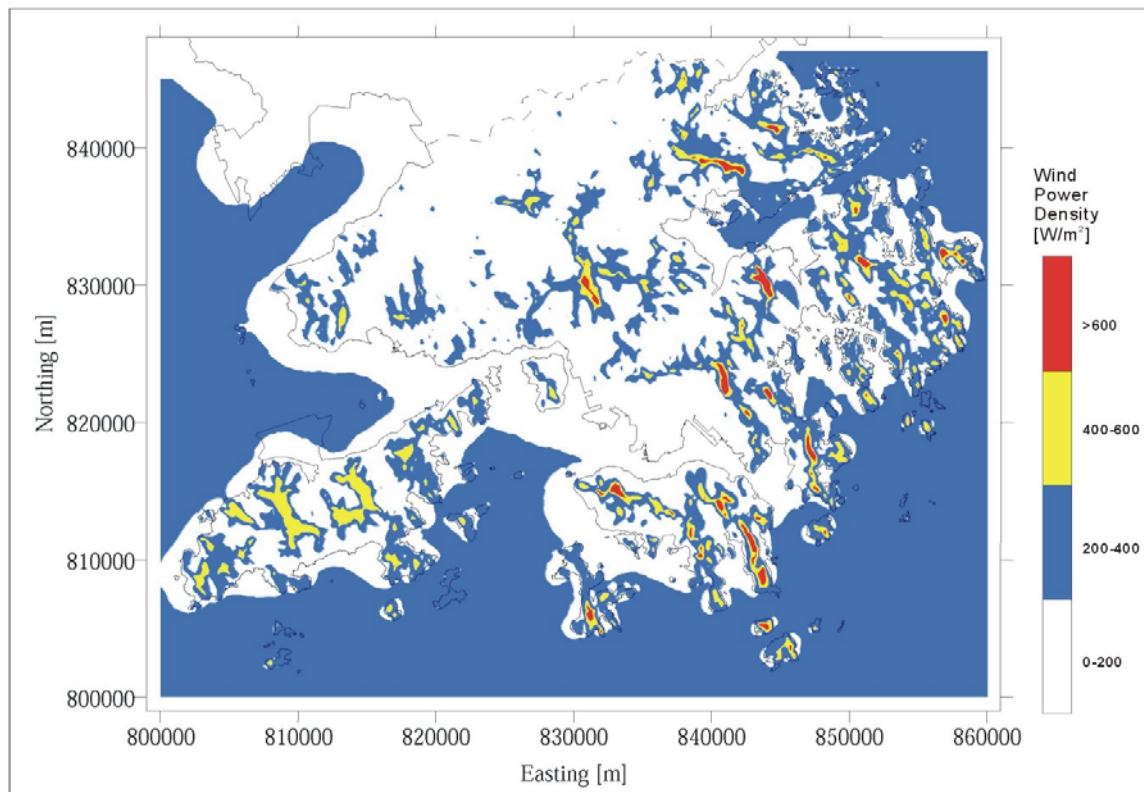

Figure 6-5: Wind Power Density over the Region of Hong Kong

6.4.2 Resource Potential

Based on the model results, probable areas of high relative wind resource can be identified. Due to the necessary restrictions on model resolution imposed by analysis of such a large area as Hong Kong, and also the limitations of applicability of the model due to topographic factors, the results are indicative. An extensive on-site wind measurement campaign is required prior to the development of any wind farm.

6.4.2.1 Wind Resources on Land

Figure 6-6 shows land areas which the model results have identified as having high relative wind energy resources ($> 400 \text{ W/m}^2$ at 65 m height). This shows that the high wind resources generally occur on top of mountains or hills.

The exact amount of energy that can be exploited at any site is subject to restrictions on land availability, other planning or land use restrictions, and acceptable turbine installation density. The latter factor is complex and site dependant, being affected by issues such as land slope and ground cover, the resulting level of turbulence in the wind, and the acceptable level of losses in energy output due to turbine interaction.

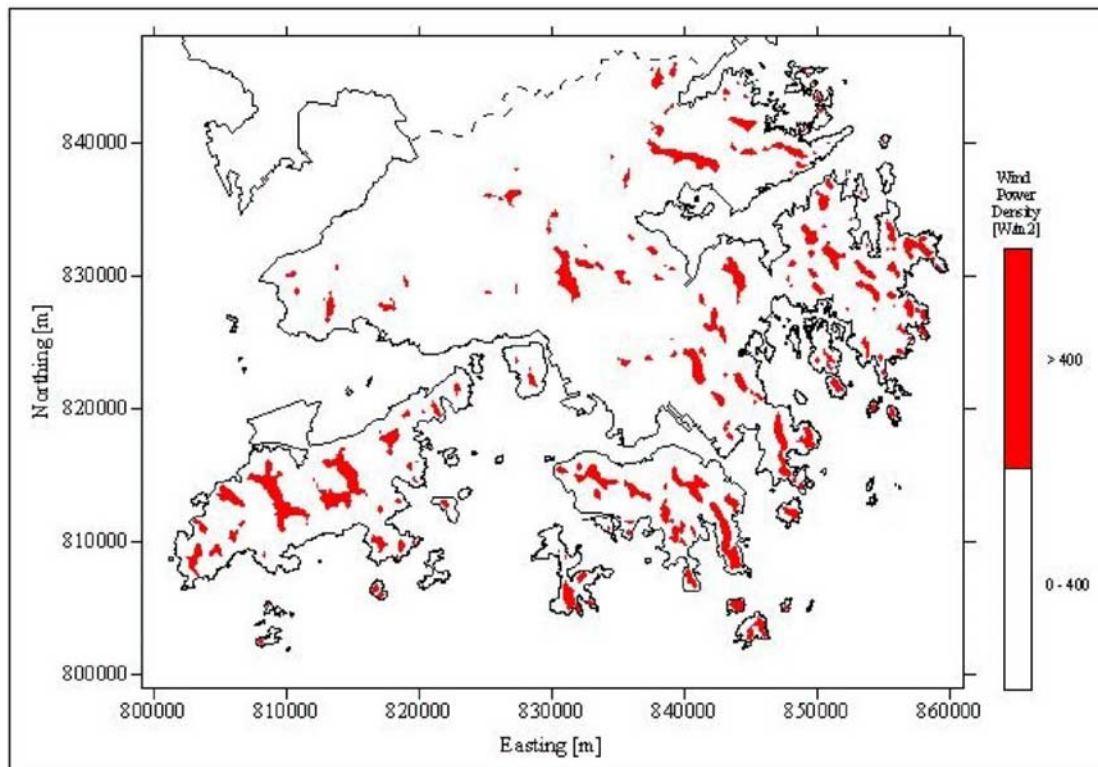

Figure 6-6: Areas of High Relative Wind Resource in the Hong Kong Region

Methods of exploiting wind resources on land can be divided into two categories, either wind farms or individual turbines.

Wind Farms

This refers to groups of large machines, usually installed in rural locations. Orientation of the machine layout can be in the form of a line or lines of machines irregularly along ridges and hills to exploit local topographic speed-up effects. In large flat areas of land, the wind farm may be in the form of a geometric array. The spacing between machines in the array is determined by the size of the machines.

The option of rural area wind farms in a *geometric array* arrangement is unlikely to be feasible for Hong Kong, due to lack of suitable sized undeveloped flat land for an array of appreciable capacity. For a better perspective, a 1 MW wind turbine has a rotor diameter of approximately 60 metres, and the entire structure would be the approximate height of a 30-storey building. This would be a sizeable construction, which would require a substantial foundation.

The option for rural area wind farms in a *linear* arrangement on mountain ridges may be considered, provided that constraints with respect to siting and construction access can be overcome. These are lines of large wind turbines (typically 1 to 2 MW each), sited along the ridge of hills and mountains in high wind resource areas.

Many modern wind turbines can achieve capacity factors in the range 20 to 30%. The estimated resource potential from this arrangement in Hong Kong is 2,630 GWh/yr, equivalent to about 7.5% of the annual power demand in Hong Kong in 1999, given the total area of the relatively high wind resource in the SAR is about 393 km².

Individual Machines

Wind turbines may also be installed individually. These are typically smaller than those installed in wind farms. They may be connected directly to the distribution rather than the transmission grid, and hence offset delivered energy costs at the retail level.

Wind turbines may theoretically be installed on the rooftops of existing high-rise buildings in Hong Kong, although there are very few examples of this in the world due to structural and safety concerns. A confidential investigation by the Consultants of a specific project established a probable limit of 40 kW capacity for a machine installed on the rooftop of a high rise building. Assuming a capacity factor of 20 to 30% for such a machine would result in a possible output of 70 to 100 MWh/yr.

The theoretical resource for urban wind farms can be approximated using these figures and the following assumptions:

- ❑ Approximately 30,000 buildings in Hong Kong, which are equal or greater than 65m in height;
- ❑ No constraints to installation of wind turbines on buildings;
- ❑ Placement of one turbine per building on average.

The resulting theoretical resource for urban wind farms in Hong Kong is therefore between 2 and 3 TWh/yr. This is equivalent to between 5% to 8% of Hong Kong's annual demand of 35.5 TWh (based on 1999 figure). However, these figures must not be interpreted as a realisable potential, as the applicability of wind turbines on buildings is not proven.

6.4.2.2 Wind Resources Offshore

This option is where wind farms are built near shore along the coastline of Hong Kong, in the shallow waters, founded on piles or other support structures for each individual wind turbine in the farm (see *Figure 6-7*). Near-shore wind farms are sited in the shallow waters along the coast and may be founded on piles or other support structures for each individual wind turbine in the farm. These are likely sited in the shallower waters (5 m to 30 m deep) along a coast in high wind resource areas. These wind farms would require submarine cabling to transmit the energy to shore for connection to the transmission grid.

The total area of the relatively high wind resource area on sea (larger than 200 W/m²) in the SAR is about 744 km², after excluding areas of major navigation/shipping channels and marine parks. Most of this area has a mean water depth of less than 30 m, and is suitable for direct wind turbine installation. The estimated resource potential from this option in Hong Kong waters is 8,058 GWh/yr, equivalent to about 23% of the annual power demand in Hong Kong in 1999.

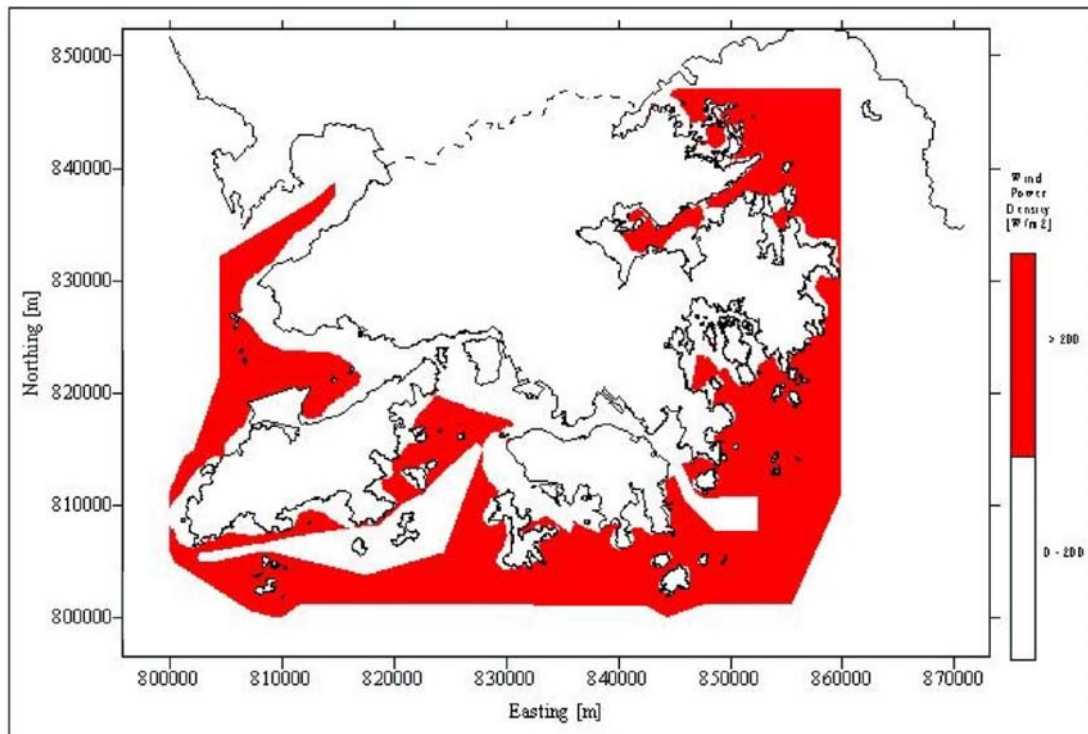

Figure 6-7: Areas of High Offshore Wind Resources in Hong Kong Territorial Waters

6.5 REVIEW OF ENVIRONMENTAL, SAFETY AND SOCIAL ISSUES

6.5.1 Safety

Structural failure of wind turbines is now very rare. Public safety is generally not at risk as turbine setbacks from housing and roads would normally prevent any danger in the event of a structural failure. Public access to wind farms is limited in most cases to avoid public safety issues. There is not yet known case of a member of the public being killed or injured by a wind turbine. However, maintenance requires work in the nacelle of wind turbines which can be hazardous. Safety measures have created a good record and few accidents occur during maintenance. From 1980 to 1994 there were five deaths of maintenance workers on California wind farms.

Construction of wind farms, particularly the erection of turbines has higher risks. While this is the period of greatest risk, fatalities from wind farm construction are low in comparison with other industries.

6.5.2 Noise

Noise is one of wind energy's most sensitive issues. It is primarily affected by the type and number of turbines, and their distance from noise-sensitive locations. Fortunately, noise can be objectively measured and can also be easily modelled.

Most commercial turbines have sound power levels at source of between 96 and 102 dB(A). Many noise mitigation measures are now included in wind turbine design. These include good blade tip design and limited tip speeds. Much attention has also been given to the

acoustics of the gearbox and generator, since these are sometimes the source of tonal noise. This can be mitigated by means of good sound attenuation design of the wind turbine nacelle via measures such as using sound absorbing materials within the nacelle and sealing the nacelle.

Noise at low wind speeds is most problematical, and variable or two speed wind turbine designs reduce this problem by means of reduced rotor speed (and hence blade tip speed) at low wind speeds. Rotor orientation (upwind/downwind) is also a factor.

In most cases, the application of appropriate planning and wind farm design criteria can minimise noise problems via an appropriate buffer distance between wind turbines and the closest houses or other noise sensitive locations.

6.5.3 Visual intrusion

Visual intrusion is probably the biggest planning issue for many wind farms. This is a very subjective issue, and has a wide range of effects on people.

Planning tools can help to minimise problems, by means of assessing those areas which will be impacted by visual intrusion. This can be done by estimating zones of visual influence, which are those areas within which all or part of a specific wind farm layout can be seen. The layout can then be altered to minimise visual intrusion from specific sensitive locations. A good public consultation programme can help minimise the problems associated with both visual and noise issues.

6.5.4 Birds and other effects

Known effects, based on documented evidence show generally very minimal impact. Sites which are on the migratory routes of some types of birds may be a problem. Lattice towers which allow perching increases the risk for some bird species. Raptors (hunters) appear to be at greater risk than other birds.

6.5.5 Social impacts

The major local impact occurs during the site development and construction stages. These may often have a generally negative affect on the local community, due to issues such as construction and transport vehicle traffic affecting local roads. Employment during construction is significant, though operational manpower requirements are usually modest.

Tourism usually increases to the site of wind farms, and suitable viewing area(s) with appropriate signage should be included in the wind farm design. Positive environmental impact includes the reduction of CO₂ output which would be generated from a fossil fuelled plant producing the equivalent electrical output.

6.5.6 Wind Energy Issues Specific to Hong Kong

6.5.6.1 Typhoons

One issue regarding the suitability of wind energy for use in Hong Kong is the ability of wind turbines to withstand typhoon conditions. On average, 30 tropical cyclones form in the north-

west Pacific and the South China Sea every year and about half of them reach typhoon strength (maximum wind speeds of 33 m/s or more).

On average, six of these tropical cyclones threaten Hong Kong every year, and two come near enough to cause gale force winds locally. About once in every four years the centre of a fully developed typhoon passes sufficiently close to cause winds of hurricane force. The highest gust wind speed recorded over a 28-year period at 74.8 m height at Waglan Island, an exposed meteorological station in Hong Kong waters, is 63 m/s.

As described earlier, Class I wind turbine certification provides for design to withstand gust wind speeds of up to 70 m/s. Site specific machine certification is also available for sites with a higher 50 year return period 3 second gust. It is therefore expected that extreme wind conditions experienced in Hong Kong will not be a significant obstacle to the development of wind energy.

6.5.6.2 Land Availability and Offshore wind turbines

With a land area of approximately 1,098 km² and a population of 6.8 million, Hong Kong has one of the highest population densities in the world. Planning issues may therefore significantly constrain the number of viable wind farm sites on land.

A growing area of interest in Europe is the viability of offshore wind farms. In addition to the significantly higher wind speeds which are often found offshore, many of the noise, visual intrusion and safety issues associated with land-based wind farm developments are avoided or reduced. Most interest is centred on development in shallow coastal waters, due to the higher cost of footings in deep water.

6.5.7 Evaluation of Environmental Effects

The environmental effects of the wind energy options have been assessed and the results suggest that of the wind energy systems:

- ❑ Urban rooftop wind turbines would appear most favourable environmentally, as they do not generally impact on the natural biophysical environment (e.g., ecology, water quality, etc). It is acknowledged that noise, safety, and visual are potential concerns with urban rooftop wind turbines.
- ❑ Near-shore wind farms (where turbines are individually founded onto the seabed) would have a higher level of potential environmental impact/risk compared to urban rooftop turbines. While near-shore wind farms would have comparatively lesser degree of noise, safety and visual implications relative to urban rooftop turbines, the former could have a higher level of impact in terms of water quality, marine ecology, fisheries and construction waste generation.
- ❑ Rural wind farms (where turbines are sited along ridgelines of mountains in rural areas) would be close to near-shore wind farms in terms of environmental performance. The difference is that one would impact on land based ecosystems, while the other marine ones. Construction and operation of rural wind farms also could generate higher levels of air quality and noise impacts, respectively, compared to near-shore wind farms.

- ❑ Offshore wind farms on dedicated artificial islands would be least preferable environmentally, as there could be potentially higher water quality and ecological impacts associated with the island reclamation works compared to all other options.

6.6 ESTIMATES OF GENERATION COSTS

As with PV systems, a levelised cost of electricity (LCE) in terms of \$/kWh was calculated for each of wind energy deployment options. *Appendix A* contains the cost models that were developed to estimate the LCE for each of the wind energy development options, including the assumed deployment scenarios, equipment price drop trends, breakdown of raw cost data, as well as a comprehensive sensitivity analysis.

Table 6-2 summarises the estimated LCE for each option. It should be noted that land costs are excluded from all LCE calculations. The table shows that rural and near-shore wind farms have the lowest LCE, followed by urban wind turbines. Offshore wind farms on artificial islands are the most costly, due to the high cost associated with the reclamation works, which accounted for 90% of capital cost per kilowatt.

Table 6-2: Summary of Levelised Cost of Electricity of Wind Power Generation

Wind Energy Option	Levelised Cost of Electricity
Rural Wind Farms	\$0.20/kWh to \$0.35/kWh
Individual Urban Wind Turbines	\$1.32/kWh to \$2.3/kWh
Near Shore Wind Farms	\$0.36/kWh to \$0.64/kWh
Offshore Wind Farms	\$9.00/kWh to \$18/kWh

6.7 IMPLEMENTATION ISSUES

6.7.1 Institutional Restrictions

6.7.1.1 *Planning and Land Related Issues*

Siting of wind power systems can be one of the principal barriers to successful implementation of the technology. Wind turbines need to be sited in areas of moderate to high wind speeds, and also require appropriate terrain on which the turbine(s) can be located. On land, this can result in conflicts between land use priorities, especially where the principal windy regions are also conservation areas (country parks, site for special scientific interests, etc.). Further constraints to the acceptability of wind installations include visual, noise and access limitations, all of which will need to be considered when considering the siting of a new wind development.

6.7.1.2 *Institutional Barriers*

The activities of a wide range of different organisations, both public and private, may limit the successful implementation of wind energy developments. Public organisations include national and local policy makers, planning and land use departments, energy departments and conservation departments. Without positive, practical support from these types of public organisations, wind energy is unlikely to be able to be developed to a great extent, except as 'one-off' developments.

6.7.2 Commercial viability

Wind energy systems have high initial capital costs, although operating and maintenance costs for land based wind turbines are now competitive with conventional fossil power generation. Costs of building and operating land based wind energy systems have dropped dramatically in recent years. There are a number of reasons for this. The typical size of turbines has increased, with consequent economies of scale, and the experience and market expertise of manufacturers and developers has expanded. National policies in some European countries (such as Germany, Denmark, UK) are broadly supportive of renewable energy technologies, and as a result, financial institutions are more willing to support wind energy developments, and this greater market demand has further stimulated cost reductions. Small turbines, however, are generally only viable in niche market situations where small quantities of power generation are required.

6.7.3 Social Acceptability

Wind turbines are by their nature a highly visual energy technology, so public acceptability of wind energy developments is essential. However, the level of public awareness and understanding of the role that wind energy plays is still only limited. With reference to experience in many European countries, although wind energy contributes at a national level towards reducing greenhouse gas emissions, the impact of wind energy is mostly seen at the local level in terms of visual, noise and environmental impacts. These local dis-benefits are often considered to be of greater importance than the national benefits, and public opposition can prevent new installations. For example, this has been the case in the UK in recent years, to the extent that very few new wind farm proposals have been successful there in gaining planning permission.

6.8 CONCLUSIONS

Methods of exploiting wind resources on land can be divided into two categories, either wind farms or individual turbines. The term wind farms refers to groups of large machines, usually installed in rural locations. Orientation of the machine layout can be in the form of a line or lines of machines irregularly along ridges and hills to exploit local topographic speed-up effects. In large flat areas of land, the wind farm may be in the form of a geometric array. Wind turbines may also be installed individually. These are typically smaller than those installed in wind farms. They may be connected directly to the distribution rather than the transmission grid.

The options assessment has indicated that for wind energy technology, the option of rural area wind farms in a geometric array arrangement is unlikely to be feasible for Hong Kong, due to lack of suitable sized undeveloped flat land for an array of appreciable capacity. For a better perspective, a 1 MW wind turbine has a rotor diameter of approximately 60 m, and the entire structure would be the approximate height of a 30-storey building. This would be a sizeable construction, which would require a substantial foundation. The option for rural area wind farms in a linear arrangement on mountain ridges may be considered, provided that constraints with respect to siting and access can be overcome.

Individual machines in urban areas, has several design issues which must be addressed prior to proceeding, such as, safety, building stability, foundation stability, noise and vibration impact. The resource potential can be significant in Hong Kong, with a theoretical resource for

urban wind turbines for the whole of Hong Kong is estimated between 2 and 3 TWh/yr. This is equivalent to between 5% to 8% of Hong Kong's annual electricity demand. The previously stated issues are not considered "insurmountable", therefore this technology is recommended for further study.

Near-shore wind farms and offshore wind farms are recommended for further site specific evaluation, provided that the baseline constraint issues, such as avoidance of beaches, fish culture zones, seabed utilities and marine shipping channels, are addressed. In this case, a one km² near shore or offshore wind farm may generate about 7.6 to 11.4 GWh/yr.

7 FUEL CELLS

Fuel cells produce direct current (DC) electricity from the electrochemical potential created by a fuel (e.g., hydrogen) and an oxidiser (e.g., oxygen). Fuel cells are similar in construction and operation as batteries, but are designed to minimise sacrificing of electrodes and are fed reactants continuously. Batteries, on the other hand, store their energy in the power-producing electrodes, which are consumed as power is delivered and rebuilt during recharging. Fuel cells are typically composed of individual anode/electrolyte/cathode “cells” that are assembled serially into stacks. Each cell is partitioned from the next cell by a “separator” (a.k.a., “bi-polar”) plate. *Figure 7-1* illustrates a basic fuel cell.

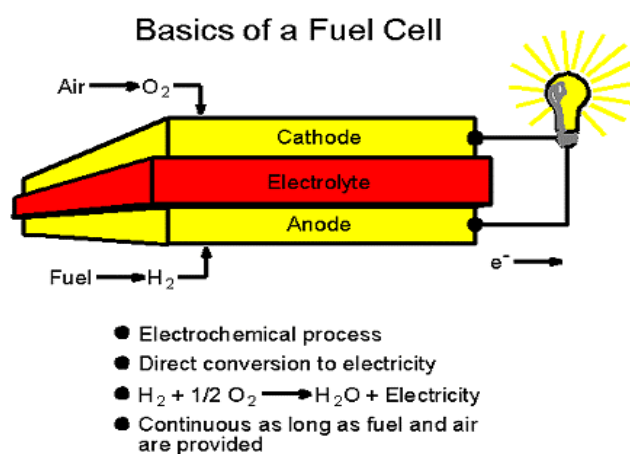

Figure 7-1: Basic Fuel Cell Diagram

7.1 TYPES OF FUEL CELLS

Fuel cells are identified by their electrolyte. The main types of fuel cells are; alkaline (AFC), proton exchange membrane (PEM), phosphoric acid (PAFC), molten carbonate (MCFC) and solid oxide (SOFC). Each fuel cell uses specific electrochemical reactions to produce electricity, operate at different temperatures and use different catalysts. Their characteristics are summarised in *Table 7-1*.

Table 7-1: Summary of Major Differences of Fuel Cell Types

	AFC	PEMFC	PAFC	MCFC	SOFC
Electrolyte	Mobilised or Immobilised Potassium Hydroxide	Ion Exchange Membrane	Immobilised Liquid Phosphoric Acid	Immobilised Liquid Molten Carbonate	Ceramic
Operating Temperature	65 - 220°C	80°C	205°C	650°C	800-1000°C now, 600-1000°C in 10 to 15 years
Charge Carrier	OH ⁻	H ⁺	H ⁺	CO ₃ ⁼	O ⁼
External Reformer for CH₄	Yes	Yes	Yes	No	No

	AFC	PEMFC	PAFC	MCFC	SOFC
Prime Cell Components	Carbon-based	Carbon-based	Graphite-based	Stainless Steel	Ceramic
Catalyst	Platinum	Platinum	Platinum	Nickel	Perovskites
Product Water Management	Evaporative	Evaporative	Evaporative	Gaseous Product	Gaseous Product
Product Heat	Process Gas + Electrolyte Calculation	Process Gas + Independent Cooling Medium	Process Gas + Independent Cooling Medium	Internal Reforming + Process Gas	Internal Reforming + Process Gas
Primary Applications	Aerospace, Marine, Transportation, Stationary, Portable	Aerospace, Marine, Transportation, Stationary, Portable	Stationary, Transportation	Stationary, Marine	Stationary, Transportation
Stack Fuel	H ₂	H ₂	H ₂	H ₂ , CO	H ₂ , CO, CH ₄
Reactant Diluents	-	CH ₄ , CO ₂ , H ₂ O	CH ₄ , CO ₂ , H ₂ O	CH ₄ , CO ₂ , H ₂ O	CO ₂ , H ₂ O
Catalyst Poisons	CH ₄ , CO ₂ , H ₂ O, CO, S (H ₂ S & COS)	CO (>10 ppm) S (H ₂ S & COS) (No Studies to Date)	CO (>5,000 ppm) S (H ₂ S & COS) (>50 ppm)	S (H ₂ S & COS) (>0.5 ppm)	S (H ₂ S & COS) (>1.0 ppm)

7.1.1 Alkaline Fuel Cell (AFC)

Development of this fuel cell technology began in 1960 and was first employed by the National Aeronautical and Space Association (NASA) in the Apollo space vehicle as a source of on-board electric power. At that time, its most desirable features were its relative engineering simplicity, good performance, and high power density (W/cm²). To this day, the advantages of this technology in stationary applications remain to be its relatively straightforward design, low capital and operational costs, exceptional electrical conversion efficiency (~50% electrical, 80 to 90% co-generation) and high power density (W/cm²).

To date, other types of fuels such as natural gas, town gas and propane have not been introduced into their development. Furthermore, the requirement for pure hydrogen is essentially one of drawbacks of the AFC system. This system can not handle impurities such as carbon monoxide (CO) in the inlet air stream. In the area around the fuel stack, there are three fluid delivery systems: fuel (H₂), oxidiser (O₂), and the electrolyte (KOH). Atmospheric oxygen is used as the oxidiser in the electrochemical reaction which occurs within the fuel cell stack.

7.1.2 Proton Exchange Membrane Fuel Cell (PEMFC)

The PEM fuel cell (a.k.a., Polymer Electrolyte Membrane "PEM", Polymer Electrolyte Fuel Cell "PEFC", Solid Polymer Fuel Cell "SPFC") is a low temperature (80 C) system that requires relatively high purity hydrogen to generate electricity. They are favoured as the fuel cell power plant of choice for transportation applications because of their simple stack design, high power density, rapid start time and ability to operate at open circuit conditions.

The PEM fuel cell features a hydrated solid polymer electrolyte. Because its electrolyte is solid, unlike alkaline, phosphoric acid and molten carbonate fuel cells, hydrogen and oxygen

gases can be sealed better reducing reactant crossover, a major concern in fuel cells. It also makes the stack structurally stable, tolerating vibration and system acceleration well.

The PEM fuel cell generates electricity from electrochemical reactions at the anode and cathode, which promote ionic current through the electrolyte and electron current through an external load. The by-product of these reactions is water, in liquid phase, produced on the cathode side of the fuel cell. Specifically, the reactions are:

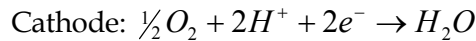
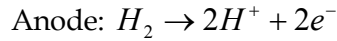

These reactions are illustrated in *Figure 7-2*.

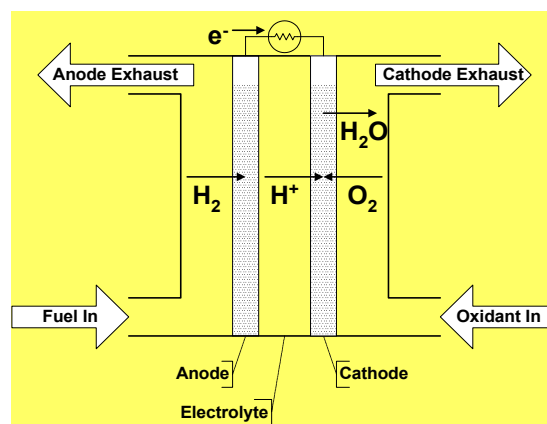

Figure 7-2: PEM Fuel Cell Electrochemical Reaction

For stationary applications, the PEM fuel cell power plant consists of the same primary subsystems as other fuel cell plants: stack, fuel processor and power conditioner. However, the stack low operating temperature, water management and intolerance of CO requires additional heat exchangers and fuel processing modules. This adds complexity and cost to the fuel cell power plant.

7.1.3 Phosphoric Acid Fuel Cell (PAFC)

PAFC's were the first fuel cell type targeted for widespread stationary deployment. The PAFC is distinguished by the use of an acidic electrolyte and dispersed platinum catalyst supported on carbon black. PAFC electrochemistry is virtually the same as a PEMFC; a hydrogen ion is the charge carrier through the electrolyte. The PEMFC stack is typically constructed of graphite resin and PTFE, which offer superior conductivity, resistance to corrosion and thermal stability. PAFC's stacks operate at 200°C and are slightly more tolerant of CO than PEMFC.

7.1.4 Molten Carbonate Fuel Cell (MCFC)

MCFC stacks operate at much higher temperatures (650°C) than PEMFC or PAFC's. This high temperature allows MCFC to avoid the use of noble metals as catalyst, theoretically lowering their cost and increasing their tolerance for fuel impurities. Just the same, sulphur and

chlorine compounds still pose potential sources of fuel processor and stack poisoning and must be limited in the reactant streams.

MCFC's utilise a molten carbonate electrolyte; typically calcium carbonate or potassium carbonate. The cell electrodes are made of porous nickel. The anode is sintered nickel and the cathode is nickel oxide. A nickel clad stainless steel separator plate is placed between cells. The separator plate also contains channels for the fuel and oxidiser gases to flow. Sealing between cells is accomplished by extending the molten electrolyte near the edge of the separator plate, thus forming what is called a wet seal.

MCFC electrochemistry is based on carbonate ion transport. Because of the specific electrochemistry, carbon monoxide as well as hydrogen may be utilised to produce electric power. MCFC's are also very comfortable with CO₂ in the fuel stream. Their high operating temperature also permits the following.

- ❑ High temperature steam production
- ❑ Internal fuel processing
- ❑ Hybrid operation with a gas turbine

MCFC are highly compatible with carbon rich fuels such as digester gas, landfill gas and gasified coal, as well as natural gas and propane. MCFC plants have been tested and operated on liquid fuels such as kerosene and distillate under US Department of Defence funding. In these tests, a pre-reformer is added to gasify the liquid fuels before reforming takes place in the stack.

7.1.5 Solid Oxide Fuel Cell

Current SOFC utilise a ceramic electrolyte made of Ytria stabilised ZrO₂. It operates at very high temperatures (>800°C), but research is underway to produce SOFC stacks that operate at lower temperatures (~600°C). There are two major stack configurations for SOFC; planar and tubular. *Figure 7-3* illustrates both configurations.

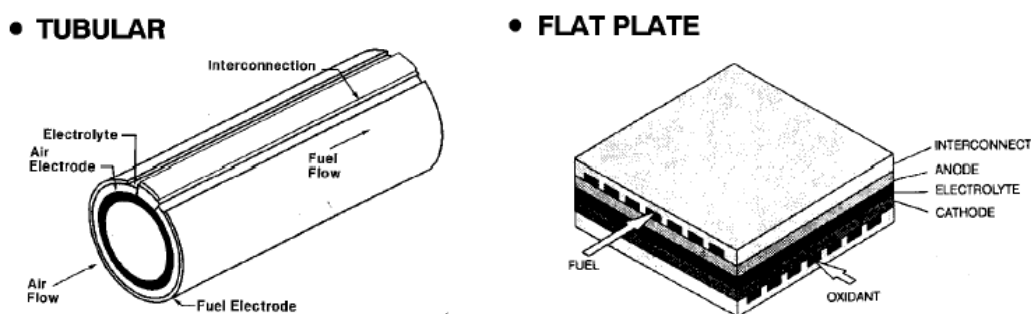

Figure 7-3: SOFC Stack Configurations (Source: US DOE)

Because of the extremely high temperature of the stack, fuel processing is conducted within the stack itself (internal reforming), like molten carbonates.

SOFC electrochemistry is comprised of the transport of an oxygen ion through the electrolyte. This forms water vapour on the cathode side which is carried away by the fuel exhaust. This reaction is illustrated in *Figure 7-4*.

SOFC power plants can use CO and CH₄ directly as fuels. However, they have sensitivity to sulphur and chlorine compounds, and particulate matter in the reactant streams.

Current SOFC planar development is primarily focused on systems smaller than 100 kW.

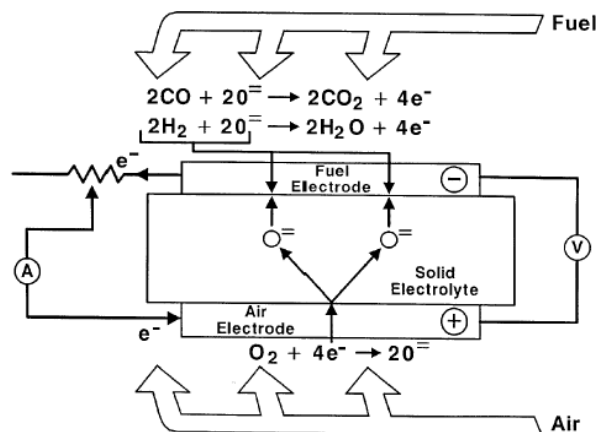

Figure 7-4: SOFC Electrochemical Reaction Illustration

7.2 STATUS OF THE TECHNOLOGIES

7.2.1 Alkaline Fuel Cell

Since 1990, ASTRIS Energi Inc. of Ontario, Canada has engaged in the development and construction of alkaline fuel cells that use pure hydrogen (99.9%) as a fuel source. They have designed a prototype system that can produce 4 kW of DC electricity at close to 50% electric conversion efficiency as well as provide low-grade thermal energy at 77°C, suitable for residential water or space heating. This type of fuel cell offers a clean source of electric power with only water as its by-product (no emissions of NO_x, CO, VOC, SO_x).

The prototype system is currently being tested at the Technical University of Ostrava located in the Czech Republic. To date, other types of fuels such as natural gas, town gas and propane have not been introduced into their development. However, ASTRIS is planning to integrate a fuel processor (manufactured by Idatech) into their system in order to increase fuel flexibility. Further more, the fuel processor, mentioned above, is capable of producing 99.99% hydrogen with less than 1 ppm of carbon monoxide. On the down side, the addition of this component increases the cost and complexity of the system.

Future developments by ASTRIS could possibly include units in the 1 to 10 kW size range. This technology is expected to reach the residential and commercial markets in the next 5 to 10 years.

7.2.2 Proton Exchange Membrane Fuel Cell

Activity in proton exchange membrane (PEM) fuel cell development has increased in the last five years because of its characteristics that are compatible with transportation applications. PEM fuel cells exhibit high power density, low operating temperature, mechanical stability, simple construction, and electrical compatibility with vehicle operation.

However, most industry experts believe that stationary PEM applications will be commercialised before fuel cell powered vehicles.¹ Stationary PEM power plants will be developed for residential and commercial applications. The apparent dominant players in the stationary PEMFC market are:

- ❑ Honeywell (Formerly AlliedSignal Aerospace) (Targeting Aerospace and Stationary PEMFC Technology Development)
- ❑ Plug Power, LLC (Joint Venture of Mechanical Technology, Inc., DTE Energy and General Electric). Figure 5 illustrates a Plug Power residential fuel cell unit.
- ❑ IDATECH (Formerly Northwest Power Systems)
- ❑ H-Power (Targeting Rural Residential Applications)
- ❑ Energy Partners (Claims Low Cost High Performance Bi-Polar Plate)
- ❑ Mosaic, LLC (Institute of Gas Technology “Endesco” and NiSource Joint Venture)
- ❑ International Fuel Cells (working with Toshiba and others on transportation and stationary applications)
- ❑ Avista Labs (Primarily Focused on Industrial and Commercial Backup Markets)
- ❑ Ballard Generating Systems (Focused on Commercial 250 kW Unit and 1-3 kW unit in Partnership with Tokyo Gas & EBARA Corporation). Figure 7-5 shows a Ballard 250 kW unit.



Figure 7-5: Ballard Generating System's 250 kW PEMFC Unit

¹ This was confirmed by recent interviews with Gerry Merten, Sr. Project Manager, XCELLSIS (June 2, 2000) and Dr. Jack Brouwer, Assistant Director, National Fuel Cell Research Center (June 5, 2000)

- ❑ Nuvera (Newly Formed Company after EPYX Acquisition by De Nora)
- ❑ Toshiba (0.5 - 50 kW Stationary PEMFC)

Stationary PEMFC power plants are not commercially available, however, demonstrations of both the larger 250 kW class and smaller 1 - 7 kW class plants are currently underway. Ballard Generating Systems is in process of field testing four units.

Plug Power has field tested an alpha units in 1998 at a New York resident. Additional demonstrations of a few hundred beta units are scheduled in 2001. Plug Power expects to have fully commercial units available by 2002.

Idatech has delivered 110 PEMFC units to Bonneville Power Authority for field demonstration in the United State's Northwest region.

7.2.3 Phosphoric Acid Fuel Cell

The leader in development and commercialization of PAFC power plants is International Fuel Cells Corporation (IFC) (a division of United Technologies Copration). IFC has been developing PAFC technology since the 1960's and is partnered with Toshiba and Ansaldo. Additional developers include Fuji Electric Corporation and Mitsubishi Corporation.

The IFC 200 kW PC25 is the only commercially available PAFC power plant. According to IFC, there are more than 200 PC25 units located in 15 countries including the U.S., Europe and Asia.

IFC's PAFC has exhibited good fuel flexibility and has been demonstrated with a variety of fuels including propane, digester gas, landfill gas and gasified MSW.

7.2.4 Molten Carbonate Fuel Cell

Currently the major U.S. developer is Fuel Cell Energy (FCE). Europe and Japan also have at least three developers: Brandstofel Nederland Industries, MTU Friedrichshafen, Ansaldo, Hitachi, Ishikawajima-Harima Heavy Industries, Mitsubishi Electric Corporation and Toshiba Corporation.

Fuel Cell Energy (FCE) has MCFC plant designs in the 250 kW, 1,000 kW and 2,000 kW capacity size range. These power plants range from 47% to 50% Low Heating Value (LHV) efficiency and can provide up to 400°C (750°F) exhaust at 5,120 SCFM suitable for heat recovery. An illustration of FCE's 1 MW unit is shown in *Figure 7-6*.



Figure 7-6: FCE 1 MW MCFC Power Plant

FCE is also developing, under US DOE funding, a MCFC/Turbine hybrid that is forecasted to have efficiencies as high as 70% in capacity sizes from 1 to 40 MW.

Currently FCE has, or is in process of supplying MCFC power plants for demonstration at 8 different locations.

MCFC are highly compatible with carbon rich fuels such as digester gas, landfill gas and gasified coal, as well as natural gas and propane. MCFC plants have been tested and operated on liquid fuels such as kerosene and distillate under US DoD funding. In these tests, a pre-reformer is added to gasify the liquid fuels before reforming takes place in the stack.

7.2.5 Solid Oxide Fuel Cell

Developers of planar SOFC technology include SOFCo (partnered with Ceramtec and McDermott Technology), Pacific Northwest Laboratories, AlliedSignal Aerospace and Ceramic Fuel Cells Limited. Current SOFC planar development is primarily focused on systems smaller than 100 kW.

Siemens Westinghouse is currently field testing a 300 kW SOFC hybrid units which are recording 60% LHV efficiency. The unit was installed at the University of California Irvine's National Fuel Cell Research Center in California in 2000. Siemens Westinghouse has commitments to demonstrate six units ranging from 250 kW to 1 MW in both simple and hybrid configuration.

7.3 RESOURCE ASSESSMENT

7.3.1 Key Characteristics of Fuel Cells

As discussed above, there are five types of fuel cells: Alkaline (AFC), Phosphoric Acid (PAFC), Proton Exchange Membrane (PEMFC), Molten Carbonate (MCFC), and Solid Oxide (SOFC). *Table 7-2* summarises their key characteristics:

Table 7-2: Key Fuel Cell Characteristics Summary

	AFC	PEMFC	PAFC	MCFC	SOFC
Electrolyte	Mobilised or Immobilised Potassium Hydroxide	Ion Exchange Membrane	Immobilised Liquid Phosphoric Acid	Immobilised Liquid Molten Carbonate	Ceramic
Operating Temperature	65-220°C	80°C	205°C	650°C	800-1000°C
External Reformer Required for CH₄	Yes	Yes	Yes	No	No
Product Heat	Process Gas + Electrolyte Calculation	Process Gas + Independent Cooling Medium	Process Gas + Independent Cooling Medium	Internal Reforming + Process Gas	Internal Reforming + Process Gas
Stack Fuel²	H ₂	H ₂	H ₂	H ₂ , CO	H ₂ , CO, CH ₄
Primary Applications	Aerospace, Marine, Transportation, Stationary, Portable	Aerospace, Marine, Transportation, Stationary, Portable	Stationary, Transportation	Stationary, Marine	Stationary, Transportation

7.3.2 Fuels Available in Hong Kong

Fuels that may be available for fuel cells in Hong Kong include:

- Town Gas
- Liquid Petroleum Gas (LPG)
- Waste Water Treatment Digester Gas
- Landfill Gas (LFG)
- Natural Gas (possible future)
- Gasified Agricultural & Solid Waste (possible future)
- Gasified Coal (possible future)

Pure hydrogen is theoretically the best fuel for fuel cells but it is not available in industrial scale in Hong Kong.

The potential applications of fuel cells in Hong Kong can be summarised as follows:

There is immediate compatibility with PAFC power plants, which are commercially available in 200 kW capacity sizes. PAFC is the only commercially available fuel cell for stationary

² "Stack fuel" is the fuel that is directly introduced into the anode side of the cell. This fuel is the result of processing of the raw fuel, which may be natural gas, LPG, town gas, digester gas or some other raw fuel.

applications and is most compatible with natural gas, town gas, LPG, digester gas, and landfill gas.

Near term opportunity exists in early deployment of MCFC power plants which offer higher efficiency (50% versus 45% for PAFC on natural gas) and greater cogeneration opportunity on all of the available Hong Kong fuels including gasified solid waste and coal.

SOFC offer a longer term potential, but testing must be completed to determine that the available fuels are compatible with SOFC plant. SOFC hybrid units offer extremely high efficiency (>60%), higher power density.

AFC and PEMFC units are best applied where LPG is available. However, certain fuel processors utilize an industrial separation membrane that can separate hydrogen directly from the town gas and utilize it directly. The remaining methane rich gas can be further processed to produce additional free hydrogen. PEMFC manufacturers are researching that possibility, but no results have been reported.

It is highly unlikely that there will be large fuel cell power plants (>10 MW) constructed in the future. Centralized fuel cell power plant is at best a future technology. Smaller fuel cell plants (1 kW to 5 MW) are more likely. They will be deployed in three different ways:

- ❑ At customer facilities in building integrated configuration.
- ❑ At fuel sources (e.g. digester on landfill gas)
- ❑ Installed throughout electricity distribution grids and may also be controlled by electricity utility companies.

7.3.3 Energy Potentials of Fuel Cells

Fuel cells generate electrical and thermal energy from a raw fuel (such as natural gas). Therefore, for fuel cells, their resource potentials are in theory only limited by the availability of the raw fuels.

In Hong Kong, the raw fuels that are or may be available include town gas, LPG, natural gas, and gas from waste (e.g., LFG, digester gas, gasified waste). *Table 7-3* summarises the electrical and thermal energy potentials of each fuel cell type by fuel. These are presented in terms of electrical and thermal energy outputs per unit volume of fuel input (kWh/m³ or MJ/m³).

Table 7-3: Fuel Cells Electricity and Thermal Outputs Summary

Type	Electrical Efficiency	Electricity Output per Unit Volume of Fuel (kWh/m ³)					
		Town Gas (17.27 MJ/m ³)	LPG (112.63 MJ/m ³)	Natural Gas (34.75 MJ/m ³)	Landfill Gas (18.848 MJ/m ³)	Anaerobic Digester Gas (21.505 MJ/m ³)	Gasified MSW (15 MJ/m ³)
AFC	50%	2.43	15.82	4.88	2.65	3.02	2.11
PAFC	38%	1.84	12.02	3.71	2.01	2.30	1.60
PEMFC	40%	1.94	12.66	3.91	2.12	2.42	1.69
SOFC	50%	2.43	15.82	4.88	2.65	3.02	2.11
MCFC	47%	2.28	14.87	4.59	2.49	2.84	1.98
	Thermal Efficiency	Thermal Output per Unit Volume of Fuel (kJ/m ³)					
AFC	35%	6,142	40,056	12,358	6,703	7,648	5,335
PAFC	50%	8,774	57,222	17,655	9,576	10,926	7,621
PEMFC	40%	7,019	45,778	14,124	7,661	8,740	6,097
SOFC	30%	5,264	34,333	10,593	5,745	6,555	4,572
MCFC	30%	5,264	34,333	10,593	5,745	6,555	4,572

It may be seen that the fuel cell resource potentials are completely dependent on their electrical and thermal efficiencies, and raw fuel energy content. The AFC and SOFC have the highest electrical power generating efficiencies of up to 50%, while the PAFC has the highest thermal conversion efficiency of 50%. The energy value of the raw fuel input is also crucial to the energy potential of fuel cell. For instance, the amount of electricity generated from a LPG-fuelled fuel cell would be six times more than one fuelled by town gas.

In practice, the potential for fuel cell deployment is governed by technical factors such as fuel availability, energy balance, and siting constraints, as well as economic considerations.

7.4 FUEL CELL DEPLOYMENT OPTION IN HONG KONG

Fuel cell applications to Hong Kong may be divided into two broad sectors: building integrated fuel cell (BIFC) and utility applications, each with a number of options as follows:

Building Integrated Fuel Cell

- ❑ *Residential* - Permanent domicile or living quarters including public and private housing blocks.
- ❑ *Commercial* - Office and other non-manufacturing facilities including institutional buildings.
- ❑ *Industrial* - Manufacturing facilities.

Utility Applications

- ❑ *Distributed Generation* - Electric utility owned and operated generators typically below 10 MW in size located at strategic sub-transmission or distribution grid locations

usually at substations.

- ❑ *Central Power Plant Generation* - Typically, power generators that are 100s of megawatts in size. Fuel cells can provide power to power plant ancillary equipment improving the power plant's net heat rate and reducing air emissions.

In order to formulate the *technical* options for each sector described above, a list of "influencing factors" specific to each sector has been formulated. Typical factors are:

- ❑ Energy Balance - Electric or thermal demand.
- ❑ Available Space - How large of a plant can be sited?
- ❑ Fuel Availability - What type and quantity of fuel is available?

For example, a fuel cell application for commercial buildings may have two likely influencing factors: peak electric demand of the facility, assuming no export of power, and available space for siting the fuel cell power plant. However, the available space may be the sole constraint that determines the maximum installed fuel cell capacity for commercial buildings. The following sections outline the potential options.

7.4.1 Building Integrated Fuel Cells

Building integrated fuel cells (BIFC) are distinguished by the location relative to the electric and thermal load they are serving, and the way they are operated to serve those loads. In BIFC applications, the fuel cell is typically located within the building's property boundary whether that is just outside of the building structure, within the building or on the roof. The fuel cell is interconnected to the building's main electric power buss on the customer's side of the electric meter. If the fuel cell is co-generating power and heat, its thermal output is interconnected via pipes and heat exchangers with the thermal load.

7.4.1.1 Residential

Because fuel cells are high initial cost generators, it is preferred, from an economic perspective, to operate them at high capacity factor. Based on the average residential electric demand profile, the capacity of a fuel cell power plant as a function of plant size has been estimated as shown in *Figure 7-7*.

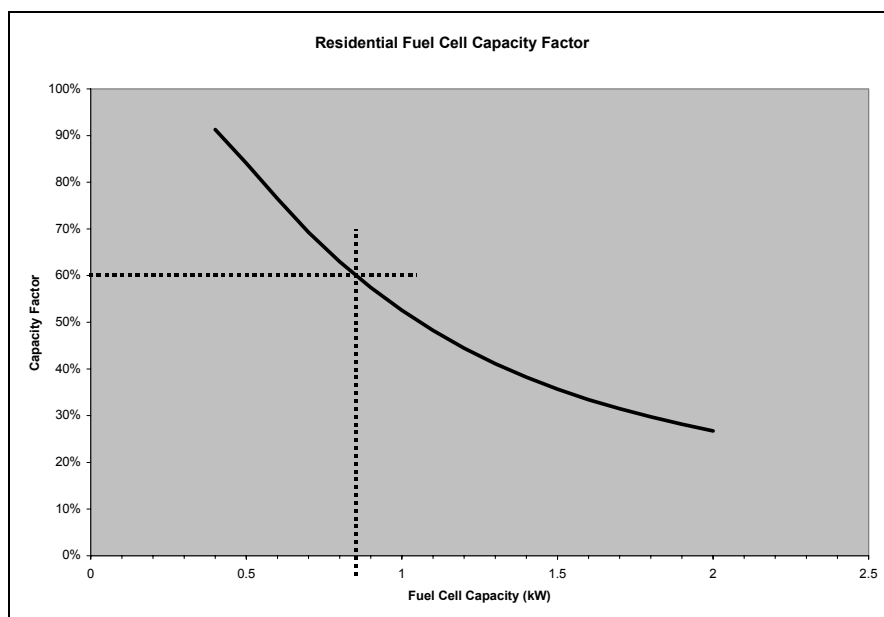

Figure 7-7: Residential Fuel Cell Capacity Factor versus Size

A capacity factor of 60% is our initial estimate of the minimum capacity factor for economically scaled fuel cell, although this is highly dependent on electric and gas fuel rates. For purposes of this assessment, this indicates that a fuel cell capacity size of 900 W per residential customer.

Another important constraint for residential fuel cell applications is the allowable space for plant installations. Since we are assuming that most of the residences are flats, either rented or owned, it is also assumed that there is little or no room for installation of fuel cell for each flat. Therefore, the fuel cell would be most likely installed in the basement of the building, which would also probably be highly space constraint. We have conservatively estimated that a fuel cell generator could serve 10% of the residential electric load. This equates to 213,200 customers or 192 MW of installed fuel cell potential.

For small individual residence loads (~1 kW) the most likely fuel cell technology compatible with the electric demand is the PEMFC. However, PEMFC's are rather intolerant of CO or CO₂, which can poison the fuel cell stack catalyst. This may be a problem with the high CO₂ concentration in town gas. PEMFC technologies that use membrane separation in their fuel processors (e.g. Idatech) are good candidates for this application.

Since it is most likely that the fuel cell would be serving a number flats in a single facility, the plant would be larger. Therefore, it is most likely that the fuel cell would be in the 200 to 250 kW range, which fits the IFC/ONSI PAFC, Westinghouse SOFC, Fuel Cell Energy MCFC and Ballard PEMFC units. However, the BALLARD PEMFC compatibility with town gas fuel or LPG is in question because of its low tolerance to CO₂.

7.4.1.2 Commercial

As in the residential application, fuel cell capacity factor gets smaller as the size of the fuel cell, relative to the demand profile, grows larger. The fuel cell capacity versus capacity factor for commercial customers is shown in *Figure 7-8*.

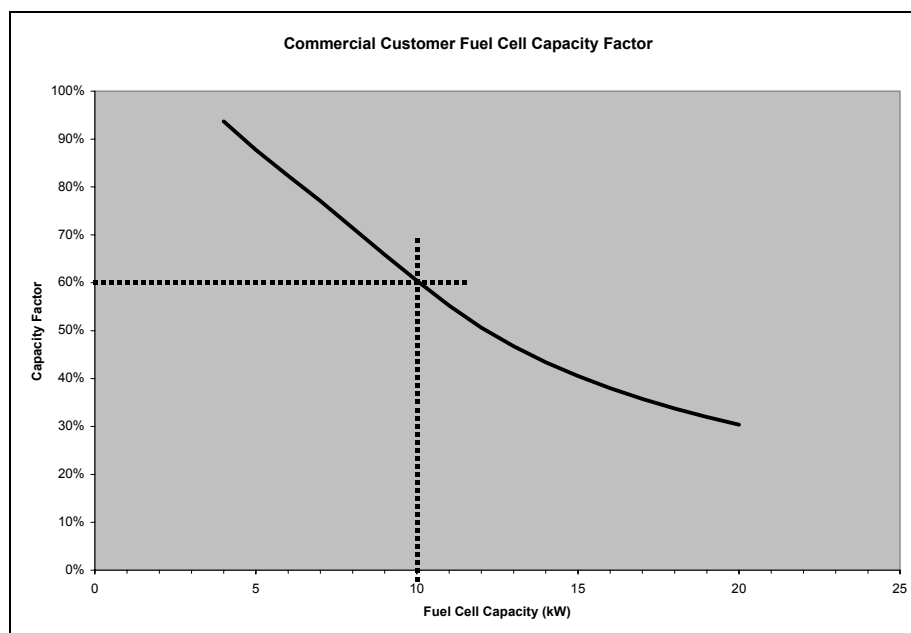

Figure 7-8: Commercial Customer Fuel Cell Capacity Factor versus Size

As shown in *Figure 7-8*, the maximum fuel cell size while maintaining at least 60% capacity factor is 10 kW per commercial customer meter. Similar residential, commercial customers are likely to be naturally aggregated in high-rise buildings. This would probably be best supplied by the 200 kW IFC/ONSI PAFC or the larger 250 kW SOFC and MCFC generators.

As in the residential sector, we would expect that space for fuel cell installation would be highly limited; probably only 10% of the commercial customer load can be served when space constraints are taken into consideration. The number of fuel cell applications is limited to those commercial customers that have access to gas fuel (68% of electric commercial customers). This translates into 290 MW of installed fuel cell potential.

7.4.1.3 Industrial

The average annual electric load factor for industrial customers is approximately 61% which is higher than commercial customer load factor (56%) or residential (39%). This is only significant in that we would expect the fuel cell capacity factor versus fuel cell size to be larger relative to the peak demand of the industrial customer than commercial or residential.

The relationship between fuel cell capacity factor and size for industrial customers (*Figure 7-9*) indicates that at a minimum 60% capacity factor the maximum fuel cell size is 17 kW per industrial customer. It is not clear whether it would be possible to aggregate several industrial customers into a larger load, however we do believe that space constraints will still be factor. However, for industrial customers we estimate that 30% of the industrial sector load could be served by a fuel cell. This assumes that industrial facilities would have more space available to site a fuel cell whether it is a small or a large manufacturer. We also believe that the fuel cell potential would be limited to those facilities that have access to gas fuel: 18,600 customers. These constraints yield a fuel cell potential of 95 MW.

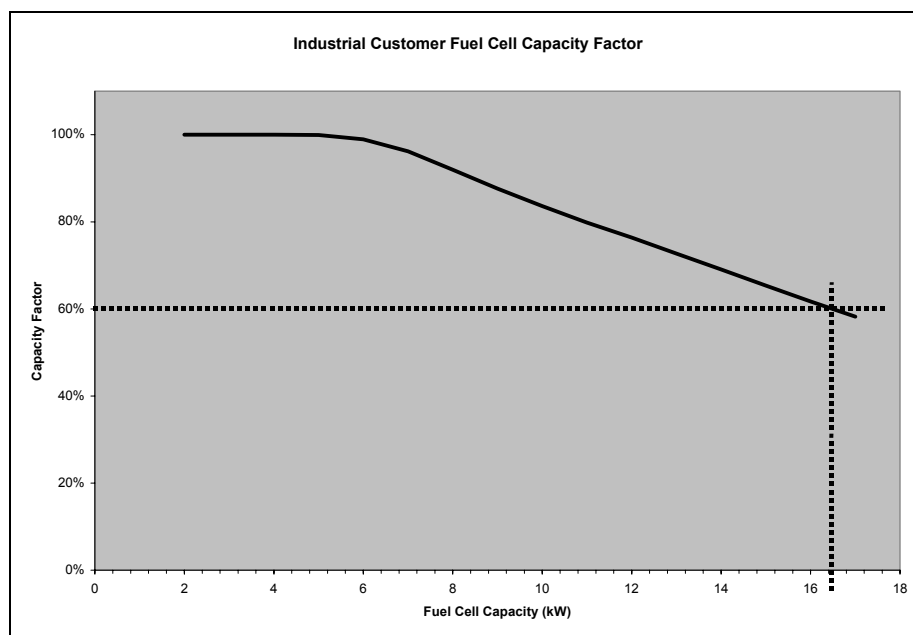

Figure 7-9: Industrial Customer Fuel Cell Capacity Factor

7.4.2 Utility Applications

7.4.2.1 Utility Distributed Generation

Distributed generators are small power plants (<10 MW) placed in strategic locations throughout a power delivery grid to provide ancillary services (e.g., voltage support, localised VAR generation and outage management) and to improve reliability of local circuits. Distributed generation has been explored by power utilities overseas as a means to provide more efficient, reliable and lower cost power delivery through existing transmission and distribution circuits. While this concept has been studied for sometime, widespread adoption has been slow.

Estimates by the Electric Power Research Institute and the Gas Technology Institute (formerly Gas Research Institute) suggest that distributed generation deployment, in the United States, could be as high as 25% of peak electric demand.

There is not sufficient local data to assess this potential fuel cell application in Hong Kong. However, a minimum estimate based on our experience in the United States may be made. We believe that distributed generators totalling at least 0.1% of peak demand could be deployed through out Hong Kong's electric grid to provide reliability, efficiency and cost reduction improvements. The peak demand for Hong Kong was 7,825 MW in 1999 (CSD, 2000). Therefore, our estimate of fuel cell distributed generator potential is 7.8 MW.

7.4.2.2 Utility Central Generation

Fuel cells are not suited for very large power plant configurations (>100 MW). However, they can provide key benefits to existing power plants by supplying electricity to ancillary loads to boost net generation, reducing emissions and providing back-up generation to existing black-start capability.

The fuel cell requires gas fuel for operation. Therefore, it would be natural for fossil fuel power plants to be targeted. However, coal and oil requires gasification before it can be used by the fuel cell which would add capital cost to the application. Central power plants that are natural gas fuelled are excellent sites for fuel cells because most fuel cell systems are designed for natural gas. *Table 7-4* shows the power plants in Hong Kong that may be suitable.

Table 7-4: Summary of Fossil Fuel Central Power Plant Ancillary Load Estimate

Power Plant	Owner/Operator	Available Fuels	Capacity	Estimated Ancillary Load (Rankine-10%, Brayton-5% of Capacity)
Black Point	CLP	Natural Gas	2,500 MW	250 MW
Lamma Extension	HEC	Natural Gas	1,800 MW	180 MW

Given lack of space on these sites, we estimate that fuel cell potential is probably limited to 1% of ancillary load. Based on these assumptions, the fuel cell potential for central power plant support is approximately 4.3 MW.

7.4.3 Summary

Table 7-5 summarises the potential options for fuel cell deployment in Hong Kong. These include building integrated fuel cells for residential, commercial and industrial applications, as well as utility distributed and central generation.

A likely upper bound potential for fuel cell power generation in Hong Kong has been estimated at 589 MW. This is equivalent to about 7% of the peak power demand in Hong Kong. However, each of the sectors where fuel cells may be applied carries varying uncertainty and technical risk.

Table 7-5: Fuel Cell Deployment Options

Technology	Resource Potential	System Type	Energy Generation Facility	Energy Form	Energy Transmission	Energy User/receiver	Energy Storage
Residential BIFC	192 MW (1 TWh/yr & 4.8 PJ/yr @ 60% Capacity Factor.)	Town gas or LPG fuelled FC application, installed in or near residential buildings providing power for the local load. Most likely, this would be a cluster of residential customers being power by a single fuel cell power plant block.	Grid isolated, BIFC system (including power conditioning, etc) Baseloaded @ 60% Capacity Factor.	AC & Waste Heat	Building Internal Wiring	Building services, e.g., air conditioning, lighting, etc	Not required
Commercial BIFC	290 MW (1.5 TWh/yr & 7.2 PJ/yr @ 60% Capacity Factor.)	Town gas or LPG fuelled FC installed in commercial building. Cogeneration opportunity. Possible absorption cooling for air conditioning with MCFC or SOFC. PAFC units have been installed on roofs and in basements.	Grid isolated, BIFC system (including power conditioning, etc) Baseloaded @ 60% Capacity Factor.	AC & Waste Heat	Building Internal Wiring	Building services, e.g., air conditioning, lighting, etc	Not required

Technology	Resource Potential	System Type	Energy Generation Facility	Energy Form	Energy Transmission	Energy User/receiver	Energy Storage
Industrial BIFC	95 MW (500 GWh/yr & 2.4 PJ/yr @ 60% Capacity Factor)	Town gas or LPG fuelled FC application installed in or near industrial facilities. Aggregating industrial customers maybe a possibility if in close proximity. Waste heat co-generation opportunity.	Grid isolated, BIFC system (including power conditioning, etc) Baseloaded @ 60% Capacity Factor.	AC & Waste Heat	Building Internal Wiring	Building services, e.g., air conditioning, lighting, etc	Not required
Utility Distributed Generation	7.8 MW (34 GWh/yr 0.16 PJ/yr @ 50% Capacity Factor)	Utility distributed generation, grid connected. Most likely will be town gas or LPG fuelled. Liquid fuels may also be an option.	Located at substations for grid support.	AC	Electric transmission and distribution grid	Utility power grid	Not required
Utility central generation	4.3 MW (38 GWh/yr & 0.18 PJ/yr @ 100% Capacity Factor)	Utility central power plant, grid connected.	Located at central power plants, as low emissions ancillary and black-start support.	AC	Internal power plant ancillary circuits	Power plant ancillary equipment: pumps, fans, etc.	Not required

7.5 FUEL CELL FOR WIDE-SCALE APPLICATIONS

Table 7-6 summarises the issues related to the deployment of fuel cells in Hong Kong.

Several raw fuels suitable for fuel cells are available in Hong Kong, though only town gas and LPG are currently supplied to the urban areas. Natural gas is supplied to selected power stations only. For all types of fuel cells, natural gas or LPG would be preferable than town gas, due to the former's higher energy value. Town gas can be used, recognising that the efficiency of the fuel cells would be reduced.

BIFC applications are beneficial by reducing electric demand on the grid, improving electric service reliability to the building, reducing air emissions from central power plants, and avoiding air emissions from gas fired boilers or space heaters. The key issue with respect to application of BIFC would be space constraints.

Fuel cells take up more room than equivalent capacity engine and gas turbine generators. Because of this, careful consideration of the location of the plant must be made prior to fuel cell installation. In addition to adequate space, the fuel cell power plant must have access to fuel gas, building electric circuits, and thermal load (if co-generating). Analysis of the various fuel cell types indicates that, on average, they require about 0.42 m²/kW of area. Therefore, for a 200 kW fuel cell, a space of 84 m² is required. The most likely location for space congested applications are in basement parking lots or mechanical equipment areas, or on rooftops. It should be noted that fuel cells are quite heavy pieces of equipment, so roof mounting would require special structural considerations.

Utility distributed or central generation requires adoption of the concept by the power companies. In addition, densely populated areas may have difficulties siting fuel cells as substations. Similarly, existing power plants in Hong Kong may not have much spare space for installation of fuel cells.

Table 7-6: Evaluation of Fuel Cell Deployment Options

Market Sector	Compatible Fuel Cell Technologies					Fuel Cell Performance Impact	Issues
	AFC	PEMFC	PAFC	MCFC	SOFC		
Residential BIFC		⊙	☒	☒	☒	Unit capacity for fuel cell is reduced by 10% to 15% from natural gas fuel specifications for town gas.	Space is a critical issue. Parallel operation with grid is dependent on utility co-operation. No rules exist for customer connection of self-generation.
Commercial BIFC		⊙	☒	☒	☒	Unit capacity for fuel cell is reduced by 10% to 15% from natural gas fuel specifications for town gas.	Space is a critical issue. Parallel operation with grid is dependent on utility co-operation. No rules exist for customer connection of self-generation.
Industrial BIFC		⊙	☒	☒	☒	Unit capacity for fuel cell is reduced by 10% to 15% from natural gas fuel specifications for town gas.	Space is a critical issue. Parallel operation with grid is dependent on utility co-operation. No rules exist for customer connection of self-generation.
Utility Distributed Generation			☒	☒	☒	Unit capacity for fuel cell is reduced by 10% to 15% from natural gas fuel specifications for town gas.	This application requires adoption of concept by utility. In addition, densely populated areas may have difficulty siting fuel cell as substations.
Utility Central Generation			☒	☒	☒	Unit capacity degradation may range from 0% to 20% depending on fuel.	Currently central power plants use quick-start reciprocating engines or gas turbines for black-start. Adoption of concept by power plant management crucial to success.

Legend:

- ☒ Fuel cell type compatible with little or no modification
- ⊙ Fuel cell type compatible but requires significant technology modification (i.e., additional costs).

7.6 REVIEW OF ENVIRONMENTAL ISSUES

BIFC systems would appear to be a preferable NRE option “environmentally”. The key advantage of BIFC systems is that they do not generally impact on the biophysical environment, being integrated into buildings. Though fuel cells do emit some air pollutants and noise, these are not considered significant issues relative to other options. Most types of fuel cells do generate CO₂ and trace amounts of NO_x and SO_x, as they mainly use natural gas (or other fossil fuels) as raw fuel.

7.7 ESTIMATE OF GENERATION COST

Levelised cost of electricity (LCE) in terms of \$/kWh was calculated for building integrated fuel cells. *Appendix A* contains the cost models that were developed to estimate the LCE for each of the wind energy development options, including the assumed deployment scenarios, equipment price drop trends, breakdown of raw cost data, as well as a comprehensive sensitivity analysis.

BIFC systems are integrated into buildings and do not consume additional natural land resources. However fuel cells are simply energy conversion machines, and do not generate energy. Therefore the generation cost of gas-fed BIFC is mainly dependent on fuel gas price. A sensitivity analysis indicates that a generation cost of BIFC is about \$2.03/kWh to \$2.4/kWh.

7.8 IMPLEMENTATION ISSUES

The key issue with respect to application of BIFC would be space constraints. Fuel cells take up more room than equivalent capacity engine and gas turbine generators. Because of this, careful consideration of the location of the plant must be made prior to fuel cell installation.

In addition to adequate space, the fuel cell power plant must have access to fuel gas, building electric circuits, and thermal load (if co-generating³). Analysis of the various fuel cell types indicates that, on average, they require about 0.42 m²/kW of area. Therefore, for a 200 kW fuel cell, a space of 84 m² is required. The most likely location for space-congested applications is in basement parking lots or mechanical equipment areas, or on rooftops. It should be noted that fuel cells are quite heavy pieces of equipment, so roof mounting would require special structural considerations.

Fuel cells are costly compared to conventional generation technologies. The cost of FC electricity could be as high as \$2.4/kWh, and is an order of magnitude higher than conventional fossil fuel technologies. Cost is a significant factor affecting the extent of fuel cell technologies being adopted in Hong Kong.

7.9 CONCLUSIONS

Fuel cells could potentially be installed as BIFC systems for residential, commercial and industrial applications, as well as utility distributed and central generation. A likely upper

³ Co-generation means production of both electricity and heat.

bound potential for fuel cell power generation in Hong Kong has been estimated at 589 MW. This is equivalent to about 7% of the peak power demand in Hong Kong.

The key technical issue with respect to fuel cell application in Hong Kong would be space constraints. There appear to be no significant environmental, health or safety issues associated with fuel cell technologies.

It is recommended that BIFC systems are suitable for wide-scale deployment in Hong Kong. Utility central or distributed generation using fuel cell technologies should be pursued with the power utilities, as they are most familiar with their generation and transmission systems. The power utilities would be in the best position to assess the viability of this concept.

8 ENERGY-FROM-WASTE

8.1 TECHNOLOGY IDENTIFICATION

Solid wastes and selected components of solid wastes, depending on local conditions, may be of value as a source of raw material for industry or fuel for the production of power. The recovery of resources and energy from wastes in a modern integrated waste management system comprises of:

- ❑ Materials processing and recovery systems (e.g., size reduction, separation, etc);
- ❑ Recovery of chemical conversion products, including heat and gases through for example, thermal oxidation (combustion) or thermal reduction (pyrolysis and gasification) processes;
- ❑ Recovery of biological conversion products, including compost and methane, through, for example, aerobic and anaerobic digestion processes;
- ❑ Recovery of energy from conversion products (e.g., using turbines and generator to produce electricity); and
- ❑ Landfill, as a disposal or storage facility for non-recoverable materials or process residues.

It is noted that recovery of materials (e.g., paper, rubber, glass, etc) from wastes is outside the scope of this study of renewable energy. Rather, the focus is on energy recovery. The above technologies are discussed below.

8.2 COMBUSTION WITH ENERGY RECOVERY

8.2.1 Overview

8.2.1.1 MSW Combustion

Heat contained in the gases produced from the combustion (thermal oxidation) of municipal solid waste (MSW) can be recovered by conversion to steam. In a modern waste-to-energy incineration facility (WEIF), combustion and energy recovery are generally accomplished in an integrated design for maximum effectiveness, economy and environmental safety.

In the description and evaluation of combustion technologies, the systems are distinguished from each other:

- ❑ Firstly, by the refuse (fuel) preparation steps (if any) and,
- ❑ Secondly, by either the extent of factory assembly or in the manner in which the refuse is combusted.

Over the years, two fundamental refuse preparation strategies have emerged:

- ❑ *Mass Burning* is where the refuse is combusted on a hearth or stoker as it is received *without* preparation. Stokers are designed to include drying, burning and ash burnout sections or zones with each of these sections requiring differing combustion air quantities. Burning unprocessed refuse avoids the substantial cost and commitment of land area for refuse shredding, screening etc. and produces a minimum total residue quantity: the inert (ash) in the waste plus the solid air pollution control reagents. The price to be paid from taking this approach is that the furnace combustion environment must be designed and operated to fully respond to any adverse process consequences arising from the heterogeneity of the waste. This technical challenge has been fully met by several firms throughout the world.
- ❑ *Refuse-Derived-Fuel (RDF) Burning* is where the refuse is first processed to generate a more homogeneous "fuel" i.e., RDF. RDF processes separate out the non-combustibles from the MSW. This in turn seeks benefits such as higher heat release intensity (with smaller, lower cost furnaces) and smaller flue gas quantities (with more uniform fuel, one expects to operate with lower excess air and, therefore, smaller (less costly) air pollution equipment. Running against these potential gains is the commitment of investment capital and land area for RDF preparation and an increase in the mass and volume of residue that must be landfilled.

Several different combustion and heat recovery designs are available for mass burn or RDF systems. Four types of combustion systems considered to be potentially viable to Hong Kong have been identified:

- ❑ Field-erected, mass burning waterwall systems;
- ❑ Modular, mass burning systems;
- ❑ Mass burning rotary combustors; and
- ❑ Fluidised bed systems burning refuse-derived-fuel (RDF).

International experiences suggest that WEIFs are considered as primarily a waste management facility, rather than a renewable energy generation facility in its own right. The sale of energy from the WEIF would be to partially offset the operating cost of the WEIF.

8.2.2 Combustion of Sewage Sludge and Livestock Waste

Combustion of *sewage sludge* and *livestock waste* has also been shown practical throughout Europe and the US. The process can remove pathogens, destroy organic contaminants and reduce the bulk of waste. As with MSW combustion, steam produced from boiler can drive a steam turbine to generate electricity.

8.2.3 Siting and Environmental Issues

The key environmental issue associated with incineration is air emissions. Refuse combustion creates flue gases which contain various pollutants including acidic gases, carbon monoxide, particulates, toxic metals, nitrogen oxides and trace organic compounds (including dioxins, furans and polynuclear aromatic hydrocarbons). To limit these pollutants to an acceptable level, an extensive air pollution control system will be installed. It has been found that with

the implementation of appropriate controls, the WEIF would not cause unacceptable health risk impacts in accordance with Hong Kong government risk guidelines. Likewise, similar conclusions have been made regarding the proposed sewage sludge incineration facility.

A one-Mtpa WEF would occupy about 10 hectares of land. If two 1-Mtpa WEFs were co-located, about 17 hectares of land would be needed. A site search exercise conducted as part of the WEIF feasibility study has revealed that only few suitable sites are potentially available for development of the proposed WEFs, due to intense competition for land in Hong Kong and also the perceived offensive nature of the facility. Land use compatibility is also a key issue in siting of a large facility like the WEIF, as the facility cannot be located in country parks, conservation areas, sites of special scientific interests, wetlands or urban areas. Though the proposed sludge incineration facility would occupy less land (about 5 hectares), similar siting issues are also likely to be encountered.

8.2.4 Summary

In summary, combustion of MSW, sewage sludge and livestock waste is a proven process for waste treatment. In terms of energy recovery, MSW is the most relevant in Hong Kong, as it accounts for over 51% of the total solid waste stream (9,269 tpd) and has a relatively high heat (calorific) value due to the presence of combustible materials.

Though it has been found that modern waste combustion technology would not cause unacceptable environmental impacts, the studies by EPD have suggested that siting remains an issue to be resolved due to the intense competition for suitable land in Hong Kong and the perceived offensive nature of the facility. In particular, certain sectors of the community are very concerned with dioxin emissions from combustion processes. This means that siting of an incineration facility would have to overcome public opposition, in addition to competition for land.

8.3 GASIFICATION

8.3.1 Introduction

Because most organic substances are thermally unstable, they can, upon heating in an oxygen-free atmosphere, be split through a combination of thermal cracking and condensation reactions into gaseous, liquid and solid fractions. *Pyrolysis* is the term used to describe the process. In contrast to the combustion process, which is highly exothermic, the pyrolytic process is highly endothermic. The characteristics of the three major component fractions resulting from pyrolysis are:

- ❑ A gas stream containing primarily hydrogen, methane, carbon monoxide, carbon dioxide, and various other gases, depending on the organic characteristics of the material being pyrolysed;
- ❑ A fraction that consists of a tar and/or oil stream that is liquid at room temperatures and has been found to contain chemicals such as acetic acid, acetone and methanol; and
- ❑ A char consisting of almost pure carbon plus any inert material that may have entered the process.

Although the details of the complex chemistry and heat transfer processes controlling pyrolysis reactions in wastes are not known, pyrolysis has been extensively studied for wood and synthetic polymers. It has been found that distribution of the product fractions varies dramatically with the temperature at which the pyrolysis is carried out. The energy content of pyrolytic oils has been estimated to be about 23 MJ/kg. Under conditions of maximum *gasification*, i.e., when most or all of the feedstock is converted to gas in preference to other products, it has been estimated that the energy content of the resulting gas would be about 26 MJ/m³. In comparison, the gross heat content of methane is about 38 MJ/m³.

8.3.2 MSW Gasification

Gasification is an emerging technology that has the potential to serve as an alternative to conventional MSW combustion. Here, the organic fraction of MSW is heated to drive off gases with substantial fuel values. Ideally, the gases should contain all the energy originally present in the feedstock. In practice, energy conversion efficiencies lie between 60% and 90% (Eden R, 2000). This gas stream can be cleaned and burned in a gas engine or gas turbine to generate electricity.

There are a number of methods of facilitating gasification reactions. Each has its merits and demerits. The two basic configurations that are often discussed are updraft and downdraft gasification. In an updraft gasifier, air is passed through the heat zone at a rate that is insufficient to support full combustion but is adequate for a proportion of the feedstock to burn and raise the temperature of the remainder to that at which thermal decomposition (pyrolysis) occurs. This is then drawn from the top of the gasifier. As the air passes up through the waste it also serves the function of drying biomass prior to its entering the gasification zone. Unfortunately, as the air passes through the waste it also commences the process of thermal decomposition. This generates oils and tars that are extracted out with the air leading to a loss of energy potential as well as contamination of the gaseous product.

The downdraft gasifier, as the name suggests, operates in the reverse direction with air being drawn through the biomass feedstock into the gasification zone. While the same level of drying is not achieved the fuel gas passes through the high-temperature zone, resulting in any oils and tars being either burned or decomposed.

A typical MSW feed will arrive at site mixed with a large percentage of non-combustible components. These will either need to be removed or passed through the gasifier. It is probable that a front-end separation process allowing recovery of recyclables would be advantageous to the whole process. This would allow recovery of materials of value as well as facilitate the removal of materials that will lead to difficulties within the gasifier itself.

One of the major difficulties will be associated with the variability of the feedstock. Unless there is some form of pre-sorting of waste streams, the waste types will vary significantly in organic make-up. This, in turn, will lead to operational difficulties related to moisture content stability and product gas calorific value variations. Whilst front-end buffering and mixing of the waste feed, as well as final product gas blending, may be employed to stabilise the system performance such problems are not readily assimilated by existing techniques. Buffering and mixing will increase operational costs as well as require additional operator intervention, neither of which assist with the optimal performance of the technology.

Drying of the MSW will not present a major problem as product gases may be employed to dry waste in a suitably designed drier. Product gas from a gasifier does, however, require attention. It will for example, contain particulate matter. It may also contain heavy metals, ammonia, hydrogen chloride, hydrogen sulphide, and NO_x. It is to be expected that the product gas will require treatment. Treatment technologies employed will include scrubbers, baghouse filters, electrostatic precipitators, and cyclone separators. Because the gas will emerge hot from the gasifier it will also need cooling. This cooling may be achieved by means of, for example, scrubbers in conjunction with removal of particulates and other soluble compounds.

8.3.3 Siting and Environmental Issues

In terms of environmental impacts, emission data generally show very low emission rates of dioxin, acid gases and other problematic pollutants. One of the key differences between gasification and combustion is that gasification occurs in an oxygen-deficient atmosphere. This in turn means that the hazardous by-products of combustion, such as dioxins and furans, have limited opportunity for formation. These latter are created by means of a cooling reaction in the presence of oxygen. Because of the high temperature in the gasifier and reducing conditions after the combustion zone, these compounds are not formed.

8.3.4 Summary

In general, the major problem associated with MSW as a feed to a gasification process is the *variability* of composition. This must be addressed, by one means or another, to produce a reliable and stable operating systems. Whilst there are significant grounds for optimism, there remain a number of areas requiring additional development to make the technology of MSW gasification both technically and commercially viable. These include pre-sorting of waste streams, the clean up of the product gas to remove potentially corrosive gases and the development of the systems required to maintain product-gas consistency in terms of gas composition and calorific value.

Nevertheless, gasification of solid wastes may become a competitive alternative to conventional mass burn or refuse derived fuel (RDF) combustors. While gasification may not offer exceptional economic advantages, gasification technologies tend to present a significantly lower air emission profile than do conventional combustion plants, especially emission of dioxins. This may merit investigation by environmentally sensitive communities or regional jurisdictions considering volume reduction technology. However, due to their limited experience, demonstration at small scales and since many are proprietary and one of a kind processes, refuse gasification technologies need to be evaluated in greater details before they can be adopted on a large scale.

8.4 LANDFILL GAS UTILISATION

8.4.1 Overview

As soon as municipal solid wastes (MSW) have been deposited in a landfill, the wastes undergo a number of simultaneous biological, physical, and chemical changes in the following (Tchobanoglous G et al, 1997):

- Biological decay of organic putrescible material, either aerobically or anaerobically, with

the evolution of gases and liquids;

- ❑ Chemical oxidation of materials;
- ❑ Escapes of gases from the landfill and lateral diffusion of gases through the landfill;
- ❑ Movement of liquids caused by differential heads;
- ❑ Dissolving and leaching of organic and inorganic materials by water and leachate moving through the fill;
- ❑ Movement of dissolved material by concentration gradients and osmosis; and
- ❑ Uneven settlement caused by consolidation of material into voids.

With the soil material and organic fraction of MSW, the end products of anaerobic decomposition are partially stabilized organic materials, volatile organic compounds (VOCs), and various gases. LFG, which is principally produced by the anaerobic decomposition, is widely regarded as source of renewable energy. Typically, the LFG found in Hong Kong's existing landfills consists of around 50 - 60% of methane (CH₄), and 35 - 40% of carbon dioxide (CO₂). In addition, a significant number of other compounds are found in trace quantities. These include alkanes, aromatics, chlorocarbons, oxygenated compounds, other hydrocarbons and sulfur dioxide.

Field experience has suggested that LFG appears within 3 months to 1 year after waste disposition, reaching a peak at 5 to 10 years, and then tapping off for periods up to 25 years or more. In the longer term, it may be possible to greatly increase the gas yields by adopting methods to optimise and conserve landfill gas production.

8.4.2 Energy Recovery

Because of the potential risk to the local and global environment from the escape of LFG, gas collection for the energy production must be designed to comply with environmental legislation. Under ideal conditions, a landfill gas collection system should be designed to ensure integration of effective environmental protection and energy recovery.

Several types of technologies are currently being used to convert the collected LFG to energy. As shown in the following *Table 8-1*, LFG utilization options generally include:

- ❑ power generation using internal combustion (IC) engines;
- ❑ gas turbines or fuel cells;
- ❑ direct supply of the gas as a medium-calorific value (CV) fuel for local commercial, industrial or residential needs; and
- ❑ processing the gas for supply as high-CV gas to piped gas systems or compressed gas vehicles.

Table 8-1: Summary of Landfill Gas Utilization Options

	Utilization Options		
	Power Generation	Medium-CV Fuel	High-CV Fuel
Technologies	Internal combustion engines	Direct combustion of the gas in a boiler or industrial furnace	Pipeline-quality gas
	Gas turbines	Gas fired chillers	Compressed gas vehicles
	Fuel cells	Industrial process heating	
		Leachate processing	

8.4.3 Summary

Landfill gas is a proven combustible and convertible fuel for electricity, heat and steam generation. In the UK, for example, landfill gas projects have been closest to full commercialisation among all renewable technologies.

It is evident that LFG is being used to produce energy in several different ways in Hong Kong. Available statistics suggest that LFG could represent a significant resource potential, though landfill gas from the decommissioned landfills will diminish over time. A more detailed resource assessment is shown in a later section of this report.

8.5 ANAEROBIC DIGESTION OF MSW

Conversion of the organic material in MSW to biogas (methane-rich gas) can be accomplished in a number of methods, including gasification and pyrolysis as considered previously, and anaerobic digestion. The technology of producing biogas from MSW by anaerobic digestion is described in this section. Unlike landfill gas generation, MSW anaerobic digestion involves biogas generation under more controlled environment in a specially designed facility. It may have a number of advantages over landfills:

- ❑ The separated organic fraction of MSW can be converted to energy in anaerobic digestion, and also used for the production of compost that can be used in agricultural or horticultural applications;
- ❑ The overall efficiency of waste management practices is likely to be improved through the removal of potentially problematic organic wastes and its product 'methane' in landfills;
- ❑ A potent greenhouse gas (methane) is recovered and beneficially used instead of being released to the atmosphere and contributing to global warming; and
- ❑ The enclosed system that enables all of the gas produced to be collected for use.

Anaerobic digestion, which is carried out in the absence of air/oxygen, occurs through the combination of a consortium of different microorganisms and processes. The following main process can be defined:

- ❑ Hydrolytic and fermentative microorganisms including common food spoilage bacteria break down complex wastes (higher molecular weight compounds) into their component sub-units, and then ferment them to short chain fatty acids, and carbon dioxide and hydrogen gases;
- ❑ Bacteria convert short-chain fatty acids to acetic acid (lower molecular weight intermediate compounds) with release of more carbon dioxide and hydrogen gases to provide main substrates for the methane bacteria; and
- ❑ Methane bacteria produce large quantity of methane and carbon dioxide from acetic acid, and combine all of the available hydrogen and carbon dioxide to produce more methane as well.

In addition to the biological processes themselves, anaerobic digestion technologies for producing methane/biogas from MSW also involve three basic steps:

- ❑ Step 1, preparation of the organic fraction of MSW for anaerobic digestion which usually includes receiving, sorting, separation, and size reduction.
- ❑ Step 2, addition of moisture and nutrients, blending, pH adjustment to 6.7, heating the slurry to mesophilic temperatures (35 - 40°C), or thermophilic temperatures (50 - 60°C). The thermophilic processes are more expensive to get up to and maintain at operating temperature, but have an advantage of sterilization of residues and greater methane yield.
- ❑ Step 3, gas collection, storage, and/or gas treatment if necessary.

In the process where MSW mixed with sewage sludge, the biogas collected usually contains 50 - 60% methane.

The gas yield of biogas is directly proportional to the composition and the biodegradability of waste feedstock (content of convertible COD), but its production rate will depend on the population of bacteria, their growth conditions and temperature of fermentation. In addition, there are a few issues that influence the rates of biogas generation from anaerobic digestion:

- ❑ composition of organic and green wastes changes seasonally;
- ❑ increases in wood/rotten component in the wastes which are not ideal for anaerobic digestion because degradation is slower; and
- ❑ seeking alternative sources of organic material to ensure continued operation of the digester.

8.6 RESOURCE ASSESSMENT

8.6.1 Introduction

This section assesses the potential amount of energy that may be recovered from solid wastes in Hong Kong. The focus is on MSW and two types of special wastes (sewage sludge and

livestock waste), components of the total waste stream having the most potential for energy recovery.

Currently, landfill gas is recovered for beneficial utilisation (e.g., electricity generation and town gas production) in Hong Kong, as discussed earlier. Also, there is extensive experience in Europe and the United States converting waste to energy. The assumptions for the energy potential estimations used in this assessment are mostly based on local and overseas case studies and literature surveys. *Table 8-2* is a summary of energy conversion factors for the purposes of this assessment. The electricity generation potential of each energy-from-waste (EfW) technology is obtained from the product of the estimated energy potential and the typical generation system efficiency.

Table 8-2: Assumed Energy Conversion Factors

EfW Technology	Energy Product		Prime Mover	Typical Electrical Conversion Efficiencies
	Form	Heating Value (MJ/ton of raw MSW or dry solid SS/LW)		
MSW Combustion	Steam	6,199	ST	32%
SS/LW Combustion	Steam	4,050	ST	32%
MSW Gasification	Gas	7,404	GT	35%
Landfill Gas Utilisation	Gas	1,618	GT	35%
Anaerobic Digestion of MSW	Gas	2,258	GT	35%
Anaerobic Digestion of LW/SS	Gas	3,546	GT	35%

Legend: SS = sewage sludge LW = livestock waste
ST = steam turbine GT = gas turbine

Note: LW consists of sludge from on-farm wastewater treatment plants and some dry manure. For the purposes of this assessment, it is assumed its energy content is similar to sewage sludge.

It is noted that landfill gas or biogas may be directly utilised in a number of applications (other than electricity generation), as reviewed earlier. However, for the purposes of this assessment, it has been assumed that the gas would be used to generate electrical energy to allow an easy comparison of resource potentials. The following sections assess the energy recovery potential from the following:

- ❑ Existing facilities; and
- ❑ Future facilities.

8.6.2 Existing Facilities

8.6.2.1 Landfills

Landfilling has been the solid waste disposal practice in Hong Kong for the past few decades. Currently, there are three operating landfills (WENT, SENT and NENT) with a total capacity of 135 million tons. In addition, 13 closed landfills, which were filled-up in the period of 1973 - 1996, have a total capacity of 72.5 million tons.

However, all closed landfills will have continuously reducing gas yield, and their resource potential is small compared to the three operating landfills. Hence, only the three landfills are

considered in this assessment. This is not to say that there is no landfill gas resource from the old landfills, but that emphasis is placed on the three large operating landfills which are likely to contain a much more significant resource potential.

To estimate the *projected* gas yields from the three operating landfills, data obtained from available landfill studies for EPD were used. The estimate shows that the quantity of annual gas production would peak at about:

- ❑ 40,000 m³/hr in around 2019 for WENT Landfill;
- ❑ 14,000 m³/hr in around 2012 for SENT Landfill; and
- ❑ 21,000 m³/hr in around 2011 for NENT Landfill.

Thereafter, gas generation will diminish with time over the next 30 to 40 years.

It is noted that there is a plan to extend the life spans of existing strategic landfills and to develop new landfills. Therefore, LFG will continue to be generated in the future, as long as waste is landfilled. In essence, these facilities would serve as “bio-reactors” to generate landfill gas (methane) from the wastes.

8.6.2.2 Sewage Treatment Works

Anaerobic digestion of sewage sludge is a common process in secondary wastewater treatment. This process produces low heating value gas (6 - 65% CH₄, ~22.4 MJ/m³). Currently the digester gas is used for internal combustion engines, which produce electricity and drive blowers, and combusted for sludge heating. Excess digester gas is flared.

In 1999, all regional sewage treatment plants in Hong Kong produce a total of 49,244 tons dry solids per day (tds/day). Digester gas production averages about 3,546 MJ/tds. Therefore, the estimated total energy potential of sewage sludge is 175 TJ, equivalent to 17 GWh of electrical output.

8.6.2.3 Livestock Waste

Currently, about 150 to 200 tpd (wet) of livestock waste is generated. This is either landfilled or treated at the Shaling Composting Plant. No energy recovery is practised at the composting facility.

8.6.3 Future Facilities

8.6.3.1 Waste Reduction Plan (WRP)

The Waste Reduction Plan (PELB, 1998) is the blueprint for waste management in Hong Kong. It has several objectives, including the following that are most relevant to energy-from-waste:

- ❑ To extend the useful life of the strategic landfills, through the *Bulk Waste Reduction Programme*; and
- ❑ To minimise the amount of waste produced that requires disposal, through the

Prevention of Waste Programme.

In terms of waste reduction targets, an overall reduction target of 40% for municipal solid wastes has been set for 2007, with respect to the base year of 1998. Table 8-3 shows the waste reduction targets nominated in the WRP, against the amount of municipal solid waste requiring disposal. If the targets in were achieved, the quantities of municipal waste requiring disposal by year 2007 would be reduced to 2.85 million tons.

Table 8-3: Waste Reduction Target and Projected Waste Requiring Disposal

	End of Final Phase Year 2007	
	Target Level (%)	Target Quantity (tpa)
Waste Avoidance, Minimisation and Materials Recovery	20	949,000
Bulk Waste Reduction Facilities	20	949,000
Municipal Waste Requiring Disposal (Landfilling)	N/A	2,850,000
Total	40	4,748,000

8.6.3.2 Projected Quantities of Sewage Sludge and Livestock Waste

According to a recent study, approximately 49,244 tons dry solids (tds) of sludge were produced in Hong Kong in 1999. In the year 2007, the estimated amount of sewage sludge would be increased to 137,271 tds.

Livestock waste projection is currently being assessed by the EPD, as part of a study on the longer-term arrangement for management of this waste stream. For the purpose of this assessment, it has been assumed that the current rate of 200 wet tons per day would be maintained.

8.6.3.3 Resource Potentials

With the implementation of the WRP, the energy recovery potential will be affected by the bulk waste reduction technologies to be adopted, as well as the amount of waste that can be avoided. This is because some bulk waste reduction technologies (such as combustion) would be more efficient than for example landfilling in terms of energy recovery. However, the amount of energy recovered could also be reduced, if waste is reduced through the waste prevention programme.

Figure 8-1 to Figure 8-3 show flow diagrams where different technologies are adopted for managing MSW and sewage sludge/livestock waste, as outlined below:

Option 1 (see Figure 8-1)

- *MSW Combustion.* Combustion is the most widely utilized EfW technology in the world, and it is commercially available. Assuming a heating value of 10,080 MJ/ton, and a conversion efficiency of 61.5%, each tonne of MSW can produce roughly 6,200 MJ of energy in the form of steam. By converting this amount of energy into electric power, it is estimated some 550 kWh of electricity would be recovered by conventional steam power plant with a typical efficiency of 32%. In 2007, a total 523 GWh of electricity would be

generated by combusting 949,000 tpa. This is equivalent to about 1.5% of the SAR's annual electricity demand (based on 1999 demand).

- *Sewage Sludge and Livestock Waste Combustion.* Although anaerobic digestion of sewage sludge and livestock waste is commonly practised, combustion is also a viable technical alternative. Each tonne of dry solid sewage sludge/livestock waste produces average 5,600 kWh of net electricity output. In 2007, a total 49 GWh of electric power would be generated from sewage sludge. For livestock waste, 3 GWh of electrical energy would be recovered annually by combusting total 7,300 dry tons of livestock waste. In total, this is equivalent to about 0.15% of the SAR's annual electricity demand (based on 1999 demand).
- *Landfill Gas.* If WRP targets were achieved, the quantities of MSW requiring disposal in year 2007 would be about 2.8 million tons. This amount of waste will generate landfill gas that have a total electricity output potential of about 448 GWh i.e., about 1.3% of HK's total annual electricity demand based on 1999 consumption figure. However, it should be noted that the landfill gas will be generated over many years, and this will be viewed as a long-term energy resource.

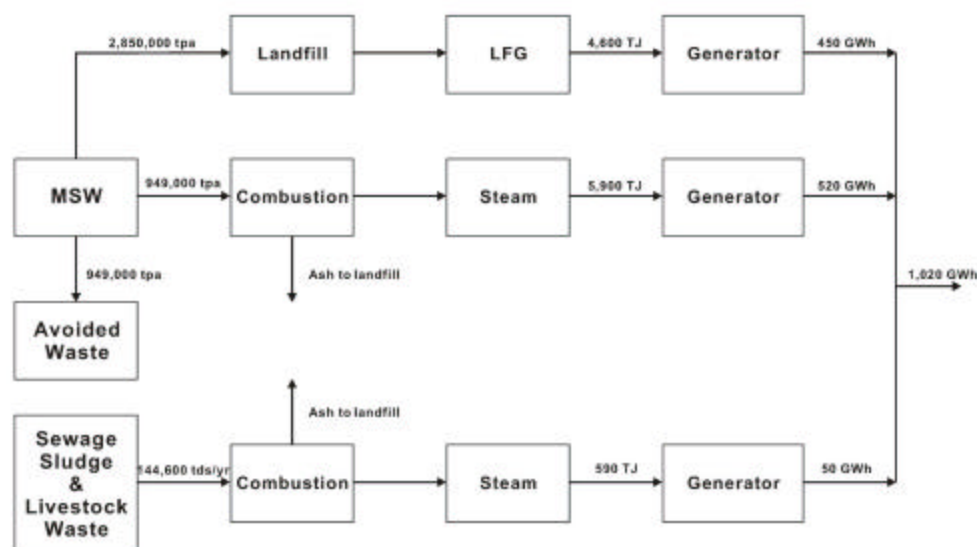

Figure 8-1: Material/Energy Flow Diagram - Option 1 (Year 2007)

Option 2 (see Figure 8-2)

- *Gasification* of organic wastes is not a new technology, and has been developed since the 1940s. However, it still has not been employed at the large scale contemplated for Hong Kong for MSW treatment. One of the barriers is that gasification requires an elaborate pre-sorting process to prepare the feedstock.

As a conservative estimate, it is assumed that 890 kg of synthesis gas may be produced from waste feed. The heating value of the synthesis gas for this kind of system typically is 7,404 MJ/ton of MSW. It is equivalent to 720 kWh of electric energy generated by a gas turbine for each tonne of waste input. Assuming that the efficiency of the electricity generating system is about 35%, in keeping with the 2007's WRP target, 0.95 million tpa of MSW would produce about 683 GWh of electricity (i.e., about 1.9% of the SAR's 1999 electricity demand).

- ❑ *Anaerobic digestion of sewage sludge and livestock waste.* According to the Sludge Treatment and Disposal Strategy Study (ERM, 1999), in 2007 all sewage treatment plants in Hong Kong will process a total of 137,271 tds/yr of sewage sludge. Anaerobic digestion of this amount of sludge will produce biogas with an electricity generation potential of about 47 GWh. In Hong Kong, about 7,300 dry tons of livestock waste are produced each year with an energy content of 26 TJ in the form of gas. It is equivalent to annual electricity output of 3 GWh.
- ❑ *Landfill Gas.* As per Option 1, the quantities of MSW requiring disposal by year 2007 would be about 2.8 million tons. This amount of waste will generate landfill gas that have a total electricity output potential of about 448 GWh.

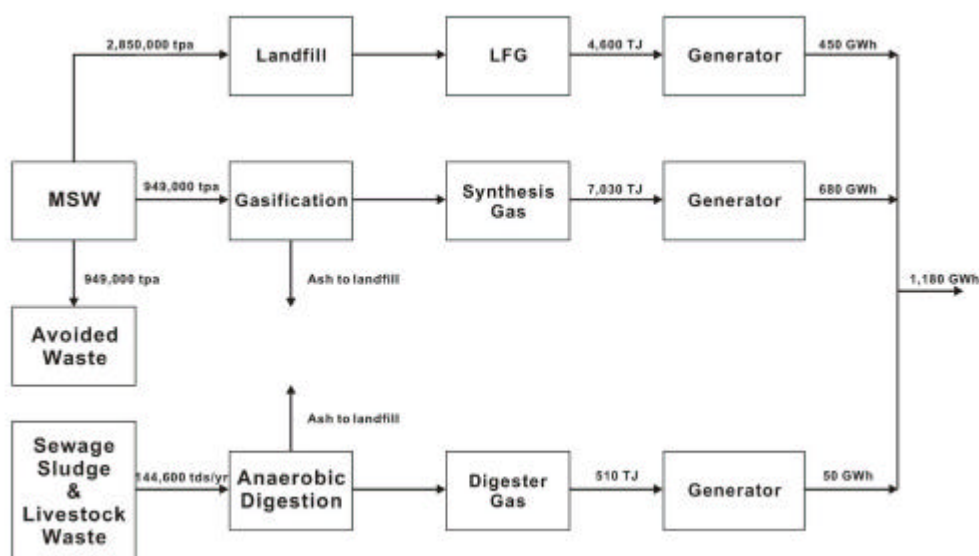

Figure 8-2: Material/Energy Flow Diagram – Option 2 (Year 2007)

Option 3 (see Figure 8-3)

- ❑ *Anaerobic Digestion of MSW.* As an alternative to recovery of gas from landfills, the organic fraction of MSW can be processed in a more carefully controlled environment (specially made digesters). Under these conditions gas yields are closer to the theoretical maximum value, and the digestion process can be finished within days rather than years.

According to IEA Bioenergy Brochure, a typical digester will produce 105 m³ of biogas with methane content of 55 - 60% for each tonne of raw MSW, that is about 2,258 MJ of useful energy each ton of waste. As with gasification and landfill gas, the product gas produced from anaerobic digestion can be then converted to electric power by gas turbine. In 2007, the resource potential would be around 208 GWh of electricity output.

- ❑ *Anaerobic digestion of sewage sludge and livestock waste.* As per Option 2, in 2007 all sewage treatment plants in Hong Kong will process a total of 137,271 tds/yr of sewage sludge. Anaerobic digestion of this amount of sludge will produce biogas with an electricity generation potential of about 47 GWh. In Hong Kong, about 7,300 dry tons of livestock waste are produced each year with an energy content of 26 TJ in the form of gas. It is equivalent to annual electricity output of 3 GWh.

- ❑ **Landfill Gas.** As per Option 1, the quantities of MSW requiring disposal by year 2007 would be about 2.8 million tons. This amount of waste will generate landfill gas that have a total electricity output potential of about 448 GWh.

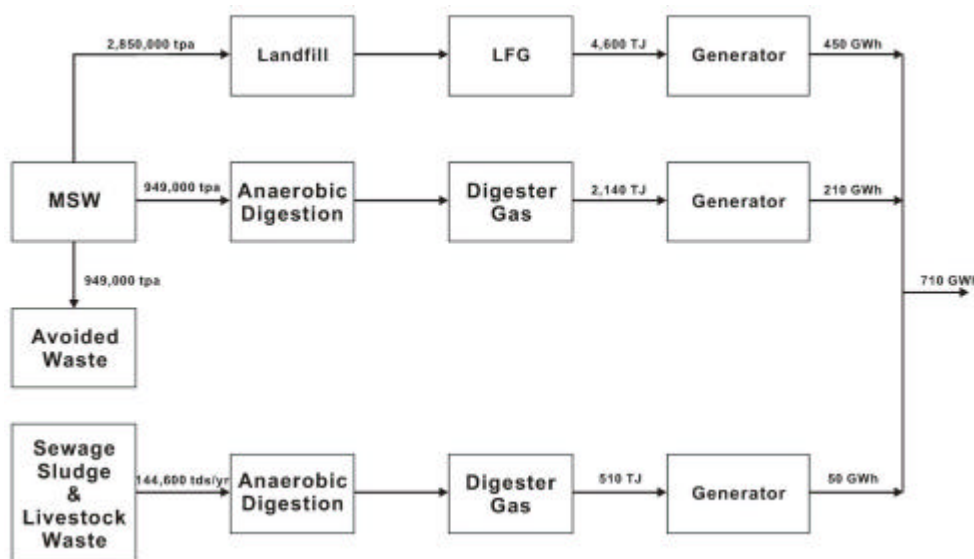

Figure 8-3: Material/Energy Flow Diagram – Option 3 (Year 2007)

8.6.4 Discussion

Under the WRP, landfilling will remain as the final waste disposal method, and a large amount of landfill gas will therefore continue to be generated in the future. It has been estimated that 2.85 million tons of MSW in landfills (i.e., amount to be disposed of at landfills in 2007) could eventually generate landfill gas with a total energy potential equivalent to 448 GWh of electricity. This is approximately 1.3% of the annual electricity demand in 1999.

As shown in *Table 8-1*, landfilling has the lowest energy conversion efficiency compared to other EfW technologies. Thermal processes (both combustion and gasification) are much more efficient in terms of energy recovery. *Table 8-4* summarises the energy potential of the different bulk waste reduction technologies under the three options.

Table 8-4: Energy Potentials for Bulk MSW Reduction Options

Option	Energy Potential from treating 949,000 tons of MSW in 2007 (GWh)
1 (MSW combustion)	523
2 (MSW gasification)	683
3 (MSW anaerobic digestion)	208

Irrespective of the technologies adopted, the above analysis suggests that MSW contain a significant energy resource potential. As an illustration, in 2007 under the WRP, it has been estimated that up to 1,131 GWh of equivalent electrical energy (consisting of 448 GWh as potential landfill gas resource and 683 GWh from MSW gasification) could be generated. This is equivalent to about 3.2% of the annual electricity demand in 1999.

As expected, energy recovered from anaerobic digestion of sewage sludge and livestock waste (50 GWh of electric power per year) is relatively small compared to the MSW, owing to the very small quantities of the SS/LW compared to MSW. This is not to say energy recovery from SS and LW is not warranted, as the energy may be used on-site to minimise demand from external sources.

8.6.5 Summary of Resource Assessment

There is a significant amount of energy resource in the existing landfills, including WENT, NENT, SENT as well as some of the closed landfills. Available data suggest that a large amount of LFG from the existing landfills is unutilised. The data also suggested that annual LFG production from all the existing landfills could potentially increase in the future, as long as waste is landfilled.

The implications of the Waste Reduction Plan (WRP) on energy from waste have also been reviewed. The WRP target for year 2007 is that 949,000 tons of MSW would be avoided, another 949,000 tons would be treated with bulk reduction technologies, while the remaining 2,850,000 tons would be disposed of at landfills. This means that despite implementation of the waste prevention and bulk waste reduction programmes, landfilling will remain as the primary final disposal method for the majority of the MSW at least in the near future.

Thermal processes are much more efficient than landfilling (which is essentially a biological conversion process) in terms of energy recovery. Therefore, thermal waste reduction (processing) technologies such as combustion and gasification would be conducive to maximisation of energy-from-waste.

Irrespective of the technologies adopted, MSW is a significant energy resource in Hong Kong. As an illustration, in 2007 under the WRP, it has been estimated that up to 1,131 GWh of equivalent electrical energy (consisting of 448 GWh as potential landfill gas resource and 683 GWh from MSW thermal processing) could be generated. This is equivalent to about 3.2% of the annual electricity demand in 1999.

Energy recovered from anaerobic digestion of sewage sludge and livestock waste is relatively small compared to the MSW. However, this energy may be utilised in-plant to minimise demand from external sources.

8.7 RECOMMENDATIONS

It has been found that waste (particularly MSW) is a significant energy resource in Hong Kong, capable of meeting up to a few percent of the SAR's annual electricity demand.

Energy-from-waste is compatible with the Waste Reduction Plan. There are several energy-from-waste technologies that may be adopted also as bulk waste reduction technologies. Some of these (such as MSW combustion) are commercially proven at large scale, while others (such as MSW gasification) are under development. It is recommended that these should be further investigated before a decision is made as to which technology should be adopted. However, it should be noted that these technologies are primarily for waste treatment. Energy recovery is practised normally to partially offset some of the operating cost of the facilities.

To this end, it is noted that studies on MSW waste-to-energy facilities, sewage sludge treatment facilities, livestock waste management, landfill extensions and identification of new landfills, and review of waste technologies have been commissioned by the EPD. These studies are currently underway and would provide a comprehensive evaluation of all relevant issues related to the implementation of these facilities and technologies. As such, it is proposed that energy-from-waste should not be further investigated in this study of renewable energy technologies. This is not to say energy-from-waste is not to be pursued. Rather, this is to avoid duplication of efforts. It is understood that the concurrent EPD waste studies would provide a more detailed assessment of the multiple issues associated with development of these facilities.

9 REVIEW OF OTHER RESOURCES/TECHNOLOGIES

9.1 OVERVIEW

As discussed previously, it has been found that solar PV technologies, wind energy systems and building integrated fuel cells are potentially suitable for wide scale application in Hong Kong. For the purposes of this Study, the following list of NRE technologies have also been reviewed:

- ❑ Biomass;
- ❑ Small-scale Hydroelectric;
- ❑ Tidal and Wave;
- ❑ Geothermal; and
- ❑ Independent Energy Storage Systems

9.2 BIOMASS ENERGY

Biomass energy technology is the utilisation of plant matter, to produce energy. The energy component of plant matter originally comes from solar energy through the process known as photosynthesis. The chemical energy that is stored in plants and animals or in the wastes that animals produce is called bioenergy. To harvest this energy, conversion processes such as combustion or burning of the biomass can be used to release the energy, often in the form of heat. The carbon is re-oxidised to carbon dioxide to replace, that which was absorbed while the plant was growing. Essentially, the use of biomass for energy is the opposite process to photosynthesis.

9.2.1 BIOMASS CONVERSION TECHNOLOGIES

9.2.1.1 *Direct Combustion*

Direct combustion is the main process adopted for utilising biomass energy. The energy produced can be used to provide heat and/or steam for small-scale applications, such as cooking and space heating. This type of application can be very inefficient with heat transfer losses of up to 90%, although the use of efficient stove technology can reduce the amount of loss.

On a larger scale biomass, such as energy crops, fuelwood, forestry residues, and bagasse, can be combusted in furnaces and boilers to produce process heat, or steam for either direct use in industrial processes, or to feed steam turbine generators for electricity generation. This method of obtaining the energy can be very economical if the biomass source is nearby. Power plant size is constrained by the local feedstock availability and is generally less than 25MW. Feedstock or fuel can be obtained from residues of ongoing agriculture and forest product industries, from harvesting forests. However, by using dedicated feedstock supplies,

such as dedicated plantations or herbaceous energy crops, the size of the plant can be increased to 50 - 75 MW.

Dedicated plantations, are normally “short-rotation intensive culture” (SRIC) plantations, of trees or of herbaceous plants, such as sorghum, switchgrass or sugarcane. The best type of trees for the energy wood crops are those which are fast growing and suitable for coppicing, such as poplar, willow, Eucalyptus and silver maple. Coppicing involves harvesting the tree after a few years and then allowing the tree to sprout again from the stump, followed by subsequent harvesting on a 2 - 5 year period. To enable the provision of continuous energy production, large tree plantations, that can provide a yearly harvest, with rotating plots, are necessary.

The process for energy crops normally entails, planting the plantation, pest control, removing under brush to prevent competition for nutrients, harvesting, wood chipping, storage and drying, transport and incineration.

Biomass can also be compacted at high temperatures and very high pressures. This process is known as briquetting and pelletising. The biomass materials are compressed in a die to produce briquettes or pellets. The briquettes have significantly smaller volume than the original biomass and thus have a higher volumetric energy density (VED) making them a more compact source of energy. The compacted state also makes the biomass easier to transport and store. The briquettes and pellets can be used directly on a large scale as direct combustion feed, or on a small scale in domestic stoves or wood heaters. The compaction process, however, consumes a certain amount of energy.

The combustion of biomass energy crops is considered a “Green” alternative to the burning of fossil fuels. The burning of fossil fuels emits millions of tons of carbon dioxide (CO₂) into the atmosphere, which contributes to global warming. Biomass may be grown sustainably in what is called a “closed carbon cycle”, where there is no net CO₂ contribution to the atmosphere. With the energy crop system, the next energy crop growing absorbs the CO₂ released during combustion. Most energy crops are perennials, and are harvested by cutting rather than up rooting. Therefore, the roots remain to stabilise the soil, absorb CO₂ and regenerate the following year.

9.2.1.2 Gasification and Pyrolysis

Aside from burning biomass, to produce steam and electric energy, a two-stage process known as gasification can be used to generate energy. Gasification is when biomass undergoes a partial combustion under a limited oxygen supply and at high temperatures in order to optimise gas production. In the first stage, the biomass undergoes partial combustion to produce a gas and charcoal, during the second stage; the charcoal is reduced to form carbon monoxide (CO), hydrogen (H₂), methane, carbon dioxide, and nitrogen. The gas is more versatile than the original solid biomass (usually wood or charcoal): it can be burnt to produce process heat and steam, or used in internal combustion engines or in gas turbines to produce electricity. The product gas can also be used to fuel spark ignition engine, such as car engines, or a compression-ignition engine, such as diesel engines.

Biomass gasification is being used at a scale of up to 50 MWe to improve the efficiency, and to reduce the investment costs of biomass electricity generation using gas turbine technology. High efficiencies (up to about 50%) are achievable using combined-cycle gas turbine systems,

where waste heat from the gas turbine is recovered to produce steam for use in a steam turbine.

Commercial gasifiers are available in a range of size and types, and can be run on a variety of fuels, including wood, charcoal, coconut shells and rice husks. The gasifier is a fluidised bed with silica media. The bed operates at a temperature of 650 – 760°C. The amount of oxygen is limited to suppress combustion and to produce a low Btu gas and a char. Then, both the gas and the char flow directly to the boiler for complete combustion to produce the biogas product.

Pyrolysis, the thermal degradation of biomass by heat, similar to gasification, but differs in that the biomass is heated without oxygen. Biomass feedstocks, such as wood or garbage, are heated to a temperature between 427 and 760°C, but no oxygen is introduced to support combustion. This conversion process produces a hydrocarbon rich gas mixture, a fuel oil, and a carbon rich solid residue (charcoal).

9.2.1.3 *Anaerobic digestion*

Anaerobic digestion is the decomposition of wet and green biomass such as wastewater (sewage), animal manure, or food processing wastes, through bacterial action in the absence of oxygen. The biomass is mixed with water, stirred and warmed inside an airtight container, known as a digester, which converts organic matter to a mixture of methane and carbon dioxide. This product is also known as biogas. The biogas, which is produced, can be burnt directly for cooking and space heating, or used as fuel in internal combustion engines to generate electricity.

Anaerobic digestion can also be used in combination with energy crops to produce energy such as using sugarcane to produce methane gas. Other energy crops, high in starch, such as cassavas and sweet potatoes can also be transformed to methane with this technology. It has however been found that among the food crops, sugarcane is the most productive.

This technology is primarily used in large-scale biogas plants. Biogas plants process livestock manure and organic waste to produce biogas. There is a wide range of animal waste that can be used as sources of biomass energy. The most common sources are manure from pigs, chickens and cattle (in feed lots) because these animals are reared in confined areas generating a large amount of waste in a small area. The treated biomass slurry at the end of the process is often used and sold as an effective fertiliser.

The biomass materials are mixed in pre-processing tanks, and then pumped into the digesting tanks, where the mix is heated and digested anaerobically, or without oxygen. The digestion process is assisted by a bacteria culture, which is introduced to the mix. During the biological decomposition process the bacteria produces the biogas. Biogas plants uses a continuous digestion process, where several times a day, the digesters are drained of a small amount of gasified biomass, and raw biomass is returned into the digester, to ensure a constant supply to the bacteria culture and a stable gas production. Typically, the biomass remains in the digesters between 12 and 25 days, depending on the processing temperature.

9.2.1.4 Fermentation

Fuel alcohol, more specifically ethanol, is produced from certain biomass materials that contain sugars, starch or cellulose. Ethanol is produced by converting the starch in the biomass to sugar, and fermenting the sugar to alcohol. Typically, the sugar is extracted from the biomass crop by crushing, mixing with water and yeast, and then kept warm in large tanks called fermenters. The yeast breaks down the sugar and converts the sugars to ethanol. A distillation process is then required to remove the water and other impurities from the dilute alcohol product (10 - 15% ethanol). The concentrated ethanol, which is 95% by volume after a single step distillation process, is drawn off and condensed back to a liquid form, which can be used as a supplement or substitute for petrol in internal combustion engines. Feedstocks such as wheat, barley, potatoes, waste paper, sawdust, and straw are typically used for the fermentation process.

9.2.1.5 Cogeneration

Large biomass power generation systems can have comparable efficiencies to fossil fuel systems, but the costs are higher due to the design of the burner, which facilitates the higher moisture content of biomass. However, by using the biomass in a combined heat and electricity production system, otherwise known as a cogeneration system. The economics are significantly improved. Cogeneration is the simultaneous production of more than one form of energy using a single fuel and facility. Furnaces, boilers, or engines fuelled with biogas can cogenerate electricity for on-site use or for sale. Cogeneration is viable where there is a local demand for the heat as well as the electricity, though this can be exported off the site to a distant user.

9.2.2 RESOURCE ASSESSMENT

9.2.2.1 Prerequisite for Sustainable Biomass Energy Resource

By far the largest potential source of biomass for energy is plantation biomass. For biomass plantations to be viable and to positively contribute to the energy supply, the goal must be to achieve and sustain high yields over large areas and over long periods, and to use efficient and effective conversion technologies. Potential land areas that can be considered for energy plantations must fulfil several key requirements, suitable climate for growing, workable topography, soil conditions, and available land space.

The prerequisites for a viable application of biogas technology, is a large supply of feedstock, primarily livestock and poultry manure and organic wastes, and close proximity of farms to biogas plant, to reduce the energy consumption and costs associated with the transport of the feedstock. The following assessment focuses on plantation biomass.

9.2.2.2 Assessment of Hong Kong Conditions

The Annual Moisture Index indicates that South East Asia is climatically suitable for plantation growth, because of the amount of rainfall and sunshine the region exhibits. According to the Hong Kong Observatory's 1999 statistics, the average annual rainfall for Hong Kong is 2,214.3 mm, and the average annual duration of bright sunshine is 1,948.1 hours, which is about 5.5 to 6.5 hours, mean daily sunshine.

Topographically, Hong Kong has hilly to mountainous terrain, with steep slopes and lowlands in the north. This may not be suitable for energy crop plantation development, because of the costs that are associated with the infrastructure for the transport of the energy feedstock, and maintenance of the plantation.

The soil conditions in Hong Kong are generally suitable for growing, particularly in the northern New Territories. This is where the bulk of Hong Kong's agricultural industry is located. However, moving away from lowlands in the north, the hilly and mountainous terrain over most of the land area in Hong Kong pose problems to plantation development, as some areas are rocky, and may not be suitable for plantation development.

Hong Kong does not have a large agricultural industry, as it contributes only to 0.1% of Hong Kong's Gross Domestic Product. Hong Kong has a total area of 1,098 km². A breakdown of land uses is shown in *Table 5-3*. From this table, it can be seen that in theory the areas of open space, woodlands, grass and shrubs and arable lands may be used for potential energy crop plantations. This land area totals 815 km². However, it should be noted that there is 415 km² area of country parks and special areas designated under the Country Parks Ordinance for protection of vegetation and wild life and for recreation. These areas may not be permitted for use as energy crop plantations for protection and conservation reasons. Therefore, the total estimated gross area potentially available for energy crop plantations would be close to 400 km². However, the actual land that may be suitable would be less, after considering environmental issues, topography and soil conditions.

9.2.2.3 *Biomass Energy Potential in Hong Kong*

By far the largest potential source of biomass for energy is plantation biomass. For biomass plantations to be viable and to positively contribute to the energy supply, the goal must be to achieve and sustain high yields over large areas and over long periods, and to use efficient and effective conversion technologies.

Given the large land area it requires and the very small energy yield, biomass energy technology is unlikely to be appropriate for wide-scale application in Hong Kong. It has been estimated that no more than 1.3% of Hong Kong's electricity needs can be met by biomass crops, even if 400 km² of land area (36% of the total area of Hong Kong) were utilised and converted into energy crop plantations. Further, the actual land area that may be available would be much less, if environmental constraints, soil conditions, and topography were taken into account.

9.2.3 **Conclusion**

In conclusion, given the large land area it requires and the very small energy yield, biomass energy technology is unlikely to be appropriate for wide-scale application in Hong Kong. It has been estimated that no more than 1.3% of Hong Kong's electricity needs can be met by biomass crops, even if 400 km² of land area (36% of the total area of Hong Kong) were utilised and converted into energy crop plantations. Further, the actual land area that may be available would be much less, if environmental constraints, soil conditions, and topography were taken into account.

9.3 SMALL-SCALE HYDROELECTRIC

9.3.1 TECHNOLOGY IDENTIFICATION

9.3.1.1 *Introduction*

Hydropower is considered renewable because the energy from the sun powers the global hydrologic cycle. The heat from the sun evaporates water from the sea, which falls as rain and finds its way into the rivers and ultimately back to the sea. The power is harnessed by means of mechanics. The flowing and falling water rotates turbines or wheels for clean and renewable power extraction.

Hydroelectric power is an established form of renewable energy that already provides a major source of electricity, approximately 19% of the world's electricity. The majority of hydroelectric power harnessed in the world today is produced from large-scale schemes. Much of this potential has been realised, but more sites can be developed. In addition, there is further scope for development of small-scale hydroelectric projects since:

- ❑ Large scale schemes have a capacity of hundreds of megawatts and usually involve the construction of a large dam to store water and to provide sufficient head for the turbine;
- ❑ Small scale schemes have a smaller capacity per site and commonly do not involve major construction of large dams and hence there is less environmental impact; and
- ❑ Micro scale schemes of a kilowatt scale, are also common for small villages and individual houses.

Large-scale hydro electric power is not considered in this present study, as it is unlikely that suitable conditions are available in Hong Kong. The focus will be on small-scale hydropower generation.

Small-scale hydropower refers to those produced from water, which flows from high points to low points, by the force of gravity. The power available in the flow is dependent on the vertical distance of fall, and the water volume. Small-scale hydroelectric systems are comprised of turbine generators and structures to channel and regulate the flow of water to the turbines. If a small dam is constructed to block the flow of water, a river or stream may be channelled through turbines connected to electric generators to produce power.

There are three basic systems available for small-scale renewable hydropower generation. These are elaborated below.

9.3.1.2 *Traditional Water Wheels*

Water wheels are the traditional devices used to convert the energy from flowing and falling water into mechanical power for direct use. The mechanical power has traditionally been used in grinding grain, and operating saws, lathes, drill presses, and pumps. Typically, the scheme is applied to an open channel of a river or stream, and the water wheel is large in diameter and slow turning. Water wheels work well in rivers and streams with large variations in flow.

In addition to mechanical energy, water wheels can also be used to produce electricity. Electric generators are more efficient when they run at high speeds, therefore, if a turbine rotates at a low speed, "step-up" gearing can be installed between the turbine and the power generator to increase the rotation speed. The water wheel having a large diameter and slow rotation, will require the rotational shaft to be geared up to a much higher revolution per minute (RPM), by the "step-up" gearing. This scheme is considered less efficient than fast rotating water turbines in the production of electricity.

9.3.1.3 Low Level Diversion Weirs (Run of River Schemes)

More commonly used, "Run-of-the-River" systems derive energy from a water flow without disrupting it as much as conventional hydroelectric power plants. Run-of-the-river hydroelectric plants utilise the river water as it passes through the plant without causing an appreciable change in the river flow.

Normally such systems are built on small dams or low level diversion weirs that impound little water, and the flow is diverted into the plant for power generation, before it joins back to the normal river channel. Often a reservoir or dam is not required, as the scheme does not include significant water storage. The plant would also not cause water quality changes such as higher temperature, low oxygen, decreased food production, siltation, increased phosphorus or nitrogen, or decomposition products associated with other hydroelectric systems. These systems are normally located on swift flowing streams or rivers.

Figure 9-1 and Figure 9-2 are conceptual illustrations of a run-of-river scheme.

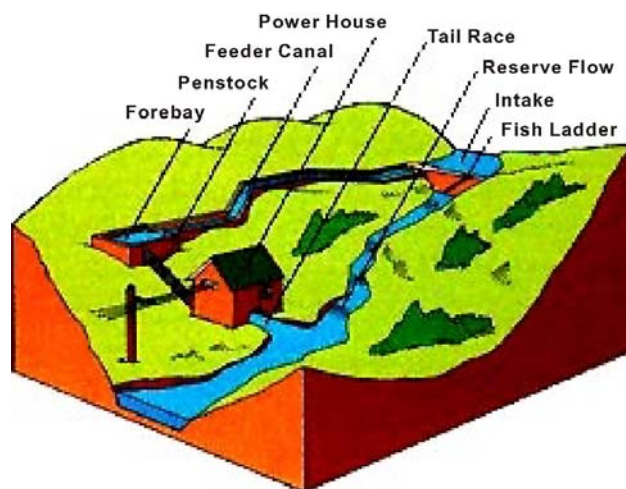

Figure 9-1: Small Hydro System (Run of River)

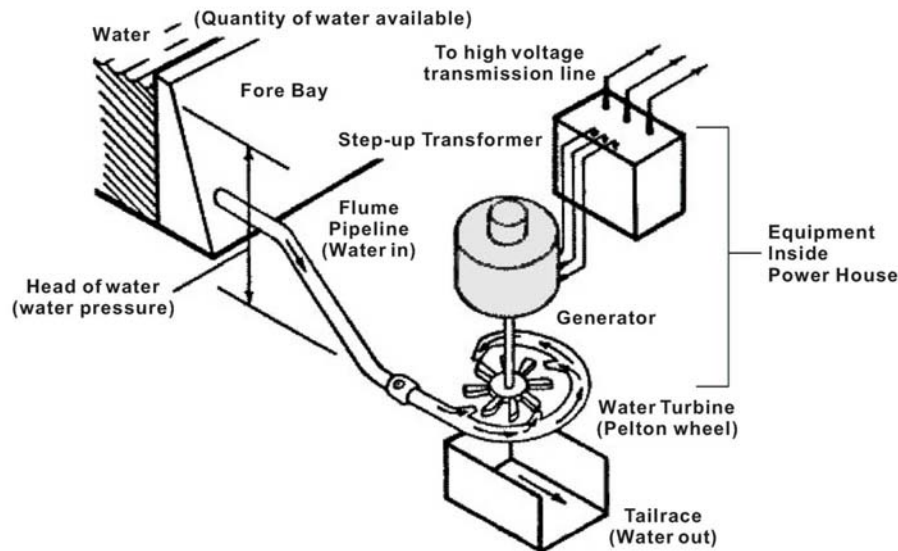

Figure 9-2: Details of Run of River Scheme Principle
(Source: Western Power Corporation)

Key elements include:

- ❑ **Feeder Canal** - Water flows down the feeder canal from the intake to the *forebay*. The canal is usually made of earth or concrete, and is fitted with a grating to keep out solid objects carried by the stream.
- ❑ **Forebay** - The *forebay* is a tank that holds water between the feeder canal and the *flume*, and acts as a hopper, which acts to help pressurise the water going through the flume. It must be deep enough to ensure that the *flume* inlet is completely submerged so that air is excluded from the power equipment.
- ❑ **Flume (a.k.a. penstock)** - The *flume* is a pipe connecting the *forebay* to the *power house*. It pressurizes the water, to create a pressurised stream to turn the turbine. The *flume* must also be capable of withstanding high pressures, and is therefore made of steel or high-density plastic.
- ❑ **Power House** - The *power house* stores and protects all the power-producing equipment and control devices, such as the turbine and generator. These devices can be operated and monitored either on site or remotely.
- ❑ **Tail Race** - The *tail race* is the flow of water out of the *power house* back into the stream.
- ❑ **Reserve Power** - Hydroelectric plants are designed to use only part of the total water flow under normal operating conditions. The reserve flow is the portion of the flow not normally used
- ❑ **Intake** - The *intake* is a buffer between the water supply and the hydroelectric plant. It is constructed of earth, masonry, concrete, or riprap. The shape is largely determined by the nature of the terrain.

- ❑ ***Fish Ladder*** – In some locations, a *fish ladder* is required to allow salmon to migrate upstream to minimise the biological impact of the power plant.

The intake structure or feeder dam/weir controls the flow of the diverted water to the forebay. A flume (a pipe) pressurises and carries the water from the forebay to the turbine. Small hydro power stations are comprised of turbine generators and the structures necessary to channel and regulate the flow of water to the turbines. The flow is directed at the wheel/blades by a nozzle or an injector allowing the flow to be adapted to the mechanical power required by the electrical equipment being driven. Water turbines spin at high speeds, and can be as high as 70 - 80% efficient in producing mechanical or electrical energy. While water wheels use water carried in an open flume or channel, turbines receive their energy from water carried under pressure.

9.3.1.4 *Retro-fit Hydro Schemes*

In some water supply or sewage schemes it may be possible to install a hydro turbine in place of a regulating valve, which wastes energy in normal operation. Since the water intake and the penstock pipework are already in place, these retro-fit installations can be very cost effective, and take advantage of an existing waterworks facility.

9.3.2 DEPLOYMENT ISSUES

9.3.2.1 *Benefits of Small Hydro Systems*

The advantage of small hydropower is that it is the only 'clean' and renewable source of energy available round the clock. It does not contribute towards climate change, acid rain, or other chemical pollution nor does it produce any solid or liquid wastes.

It is a technology that is proven and reliable, depending on the reliability of the source, and is fully commercialised. As such, the technology is available at low costs. The small hydro facility has relatively lower visual impacts and does not require large-scale flooding or civil engineering. The turbines and weirs may even benefit vegetation and fish by increasing the oxygen content of the water.

A further implication is that the power output of the system is not determined by controlling the flow of the river, but instead the turbine operates when there is water flow and at an output governed by the flow. This means that a complex mechanical governor system is not required, which reduces costs and maintenance requirements. The systems can be built locally at low cost, and the simplicity gives rise to better long-term reliability.

However, the disadvantage of small hydro systems is that water is not carried over from rainy to dry season. In addition, the excess power generated is wasted unless an electrical storage system is installed, or a suitable 'off-peak' use is found.

9.3.2.2 *Prerequisites for Deployment*

The prerequisites for successful implementation of a small-scale hydropower initiative include:

- ❑ a high rainfall catchment area;

- ❑ a river or water source with a suitable head of water;
- ❑ a water intake placed within a weir or a dam (not necessary for the waterwheels);
- ❑ a method of transporting this water to the turbine, through a pipe or channel (not necessary for the waterwheels);
- ❑ a turbine, generator, and electrical grid connection; and
- ❑ the return of water to the main flow.

The exploitation of hydroelectric power schemes is primarily dependent upon the topography, rainfall, the availability of funds, and energy production potential. It is also necessary to assess the visual intrusion upon the landscape and any changes to the local ecology that may be made.

9.3.2.3 *Siting and Environmental Issues*

It is noted that hydroelectric power generation does not contribute towards climate change, acid rain, or other chemical pollution nor does it produce any solid or liquid wastes. Water wheels and water turbines alone generally have a negligible effect on the environment.

However, a small hydroelectric facility, involving even low level diversion weirs or small dams, could impact on the natural environment by altering its flow regime. The weir may disrupt the flow of a river and form an obstacle to the free circulation of aquatic fauna.

Also, damming a river or stream can have a long-term effect on the environment surrounding the site. The stream flow is changed and the water table is usually raised behind the dam/weir and lowered downstream from the structure. A pond or lake, in essence, is being created where a stream ecosystem used to exist, silt may accumulate and become an ideal, albeit unwanted, breeding ground for mosquitoes.

Generally speaking, the visual impact of a small hydroelectric plant can be mitigated to some degree by blending the power generation plant into the surrounding landscape. The facility is not a massive structure, and can be partially screened with vegetation and local materials, to reduce the visual impact.

In conclusion, the consequent effects on water quality and ecology of a small hydro scheme must be carefully evaluated during the planning of the project to ensure that no acceptable impacts would result.

9.3.2.4 *Opportunities for Deployment in Hong Kong*

Low Level Diversion Weir (Run-of-River) Scheme

In Hong Kong, most of the rivers and waterways are located within country parks and special conservation area boundaries. There are approximately 415 km² of country parks and special areas which are designated under the Country Parks Ordinance for protection of vegetation and wild life, and for recreation.

Development of a run-of-the-river scheme requires the construction of a diversion of the river and a forebay, which holds the water temporarily until the water is released through the flume or penstock to power the turbine. This system would cause impacts to the local ecology and water flow regime, and is therefore undesirable in the generally sensitive country park areas.

Also, river flows in Hong Kong are subject to great variations throughout the year. Flows could cease at times of the year. Therefore, under normal "river-run" circumstances, the system would not provide a reliable source of power. Having water "storage" can offset the low flow periods for a more consistent power supply. However, the application of a scheme using large storage reservoirs will necessitate extensive earthworks with much significant ecological and environmental impacts during both construction and operation.

Water Wheels

The small scale hydro scheme using open channel water wheels may potentially be utilised under Hong Kong conditions, as they work well with large variations in stream flows and have minimal effect on the surrounding natural areas. While the power potential of this scheme is likely to be relatively small compared to the run-of-river system, it will have very little environmental or ecological impact. There may be local site-specific applications of technology. The resource potential of this system will be investigated in the next section of this report.

Retro-fit Schemes

Retrofit hydro schemes can be applicable in Hong Kong, as there are situations where the use of a small hydroelectric system can make use of wasted water energy, outside of a river system. More specifically, the energy from the water stored in Hong Kong's reservoirs that are subsequently released to the water treatment plants, by means of gravity flow. A small-scale hydro system can be installed at the tail end of the flow, before the water reaches the treatment plant to harness the energy. The installed system can also serve an additional purpose, of dissipating the velocity of the water flow into the treatment plant itself.

The case for the highest potential in Hong Kong is the flow from the High Island Reservoir to the Pak Kong Water Treatment Works. The gross head is approximately 30 m from the level of the top of High Island Reservoir to the inlet level at the Pak Kong Water Treatment Works. Taking into consideration, the distance, bends of the pipe, and friction, the net head can be estimated at about 25m. The potential energy is quite high, and currently, the energy is not utilised. It is proposed to further evaluate the energy resource potential of this and other similar cases in the next section of this report.

9.3.2.5 Conclusions

Small-scale hydropower is a developed technology used world wide with a wide experience base. It has the benefit of being commercialised, resulting in low costs of implementation. The three small hydropower schemes reviewed are: scheme using low level diversion weirs or "Run-of-River" Scheme; scheme using water wheels; and retro-fit hydro schemes.

The scheme using low level diversion weirs is not recommended for use in Hong Kong. This is because the quantity of energy that can be harvested would be relatively small, given the small catchment sizes and intermittent nature of the river flows. Also, these schemes could

likely cause significant amount of disturbance to the natural environment (e.g., impact to water flow, ecology, etc.).

The scheme using water wheels is recommended for further review and assessment of power potential that can be developed in Hong Kong. The retrofit scheme is also recommended for further review and assessment of power potential, for specific cases (e.g., the High Island Reservoir Scheme).

9.3.3 RESOURCE ASSESSMENT

9.3.3.1 Introduction

The energy resource potential of a small-scale hydroelectric scheme depends on the flow of water from high points to low points, by the force of gravity. Electrical power is then generated through a stream of water spinning a turbine, which in turn runs a generator. The power produced depends on the energy in the water, which is commonly expressed in terms of "head" (metres), and the water flow. Flow is the quantity of water flowing past a point at any given time. This value can vary both seasonally and annually, therefore, for an accurate estimation of resource potential of a particular site, it is important to collect long-term flow data (over several years).

9.3.3.2 Resource Potential for Water Wheel Scheme

The first system that is considered is the Run-of-River – water wheel scheme. The typical waterwheel type considered in this review, which does not involve extensive and unsightly water diversions, is the undershot vertical waterwheel. This is a large vertical waterwheel placed in a stream and is turned by the river's motion. This type of waterwheel is similar in technology to the tidal waterwheels, used in tidal energy generation.

The waterwheel plant could potentially be installed at the outlet of catchwaters or channels, to capture the water energy from the flow into Hong Kong's impounding reservoirs. The maximum theoretical potential for small hydroelectric power is calculated for the annual rainfall water yield into Hong Kong's major catchment area, as provided by Water Supplies Department (WSD).

Table 9-1 summarises the potential energy yield from waterwheels installed for Hong Kong catchments, as calculated from WSD data.

Table 9-1: Theoretical Water Wheel Energy Potential

Year	Annual Water Yield (million cubic metres)	Annual Flow (m ³ /s)	Energy Yield (kWh/yr)
1990	220.598	7.00	152,086
1991	180.211	5.71	124,242
1992	363.687	11.53	250,735
1993	360.228	11.42	248,350
1994	276.925	8.78	190,919
1995	302.481	9.59	208,538
1996	187.659	5.95	129,377

1997	224,239	7.11	154,596
1998	237,933	7.54	164,037
1999	106,367	3.37	73,332

The potential energy yield calculated from the past ten years of water collection data, ranges from a high of 251 MWh/yr to a low of 73 MWh/yr. The average energy yield for the past ten years is about 170 MWh/yr, which is negligible compared to the total electric power consumption of Hong Kong, 35.5 TWh/yr (1999 figure).

Hong Kong's catchment is approximately one third of the total Hong Kong land area. Therefore, a conservative estimate of the resource potential for Hong Kong as a whole, assuming the same average rainfall capture as that of the developed catchment areas, the total average energy yield is three times the yield of the catchment areas, 509 MWh/yr. Again, this is extremely small, 0.001% of the 1999 annual electricity demand.

The potential for the rainwater capture over the entire water catchment area would require numerous plants to be installed in the numerous rivers, streams, and channels (in the order of a hundred) feeding the impounding reservoirs. Therefore, the resource from one water wheel plant would be very small. The technology is also dependent on the flow of the rivers in Hong Kong, some of which exhibit no flow during the year.

However, while the resource potential from waterwheels is extremely small compared to the SAR's total electrical energy demand, there may be local site-specific application of this technology at remote locations within the water catchment or country park areas. As it is the objective of this study to focus on those technologies that are suitable for wide scale applications, it is recommended that the water wheel scheme should be explored separately, if deemed suitable by interested parties.

9.3.3.3 *Retrofit Scheme*

The second small-scale hydro system that may be implemented in Hong Kong is the Retrofit Scheme. A retrofit small hydro system can be installed to capture water energy from the water stored in Hong Kong's reservoirs that is subsequently released to the water treatment plants by way of gravity flow, given that there is sufficient flow and a large enough head.

A small scale hydro system can be installed at the tail end of the flow, before the water reaches the treatment plant to harness the potential energy of the water that is currently not utilised. The system can take advantage of existing infrastructure and the power produced, can augment the existing power supply either locally within the treatment plant or the energy can be fed to directly to the utility grid. The installed system can also serve an additional purpose, of dissipating the velocity and energy of the water flow into the treatment plant. The only key drawback to this system is that it may not be able to provide a continuous power supply, as the flow of water is dictated by the reservoir and/or the demand at the water treatment plant, and not by the energy demand.

The gross head is the initial level difference from the reservoir to the receiving facility. The net head is the gross head minus the losses within the water transfer or pipe system, which is a factor of pipe size, number of bends, and degree of bends. In the initial investigation and in consultation with WSD, the following three cases were found to have high potential for a retrofit system in Hong Kong:

- Flow from the High Island Reservoir, to the Shatin Water Treatment Works (see Figure 9-3)

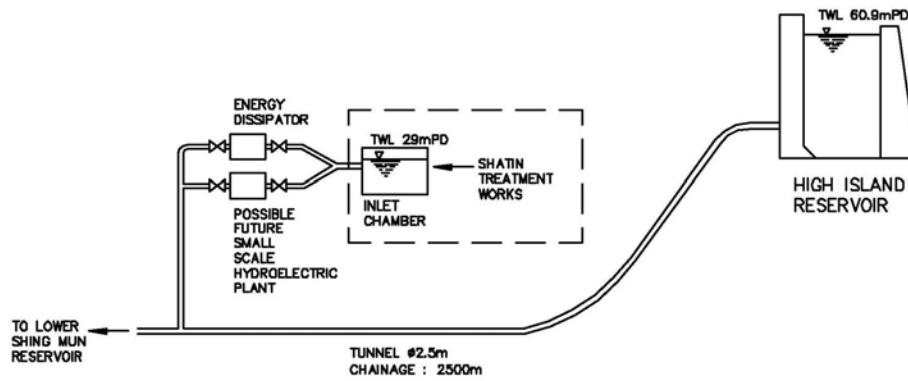

Figure 9-3: Conceptual Retrofit Hydroelectric System (High Island to Shatin Treatment Works)

- Flow from the Lower Shing Mun Reservoir to the Shatin Supply Basin (see Figure 9-4)

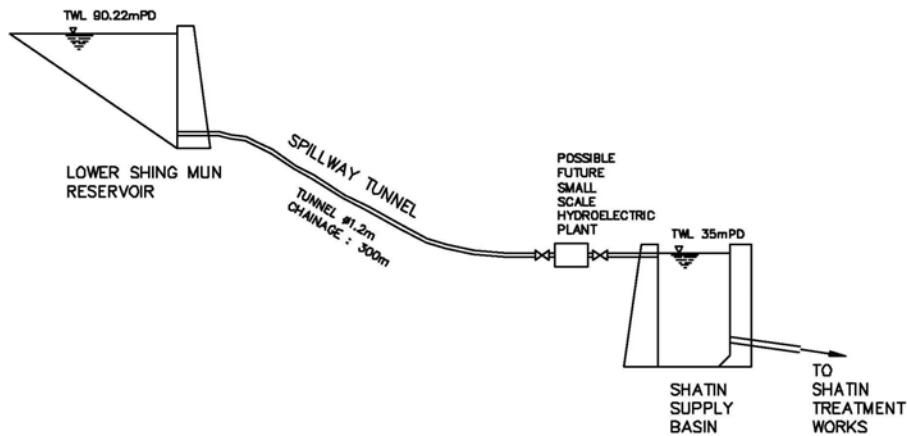
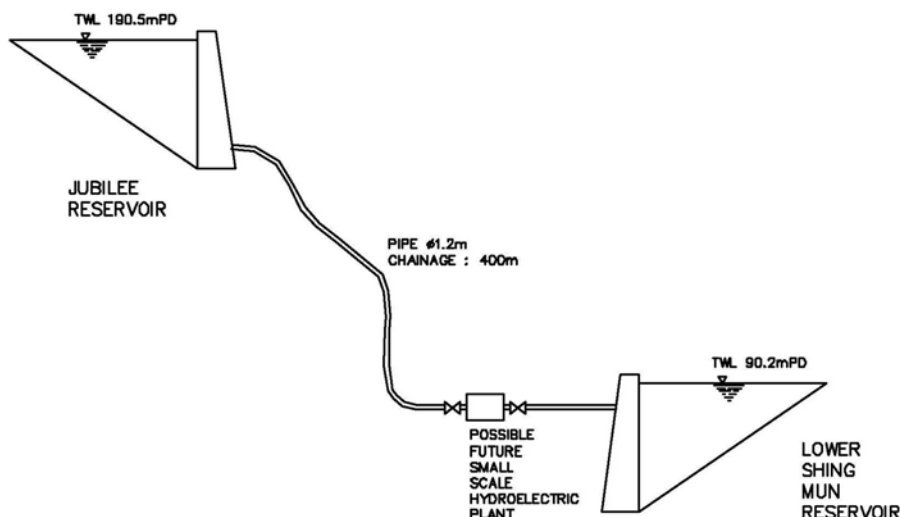

Figure 9-4: Conceptual Retrofit Hydroelectric System
(Lower Shing Mun Reservoir to Shatin Supply Basin)

- Flow from the Jubilee Reservoir to the Shatin Water Treatment Works (see Figure 9-5)



**Figure 9-5: Conceptual Retrofit Hydroelectric System
(Jubilee Reservoir to Shing Mun Reservoir)**

The maximum theoretical potential calculated for the above four cases are shown on *Table 9-2*.

Table 9-2: Small Scale Hydro Retrofit Scheme Energy Potential

Small Hydro Retrofit Sites	Average Power (kW)	Estimated Energy (kWh/yr)
High Island to Shatin Water Treatment Works	318	2,784,644
Lower Shing Mun to Shatin Supply Basin	364	3,186,997
Jubilee to Shatin	172	1,507,299
	Total:	7,478,920

It should be noted that for several of the above cases, there are months with no flow, and hence, no power production, as shown on *Figure 9-3* to *Figure 9-5*. The total energy for the above three sites is 7.5 GWh/yr. This is equivalent to 0.02% of the total electricity consumption of Hong Kong in 1999. The advantage of this scheme is that it uses the existing infrastructure, such as reservoir water storage, and water transmission system. Therefore, the impacts to the environment normally associated with hydropower are minimal.

This study is not to say that the above three cases are the only instances where small scale hydroelectric retrofit system can be used, only that the three sites chosen, were deemed to have very high potential, from the head and flow values flowing into their respective receiving facilities. Further site specific study is recommended to further outline potential sites in Hong Kong, if implementation of this technology is to be pursued.

9.3.4 CONCLUSIONS

The small hydro option of the run-of-river waterwheel scheme is not recommended for further evaluation as a technology suitable for wide scale application in Hong Kong, because the energy resource of the waterwheel scheme is not practicable, only 169 MWh/yr for the total Hong Kong water catchment. However, this is not to say waterwheels would not be suitable

for local site-specific applications. Rather, it is recommended that this should be pursued on a case-by-case basis outside the current study.

Likewise, the retrofit small-scale hydro option is recommended for further evaluation, by interested parties (for example, Water Supply Department). The retrofit system does not add any additional adverse impacts to the environment, as it will be installed in existing waterworks facilities. It utilises currently “wasted” energy, and would not require significant additional construction of infrastructure, (i.e., dams, piping, etc.). The flow may not be constant, but the energy can be used to augment the power supplied to the water treatment facility.

In a comparison of the two technology options in terms of energy resource, the total resource calculated for the three proposed retrofit sites is 7.5 GWh/yr. This is 14 times greater than the total resource potential estimated for the waterwheel scheme for the whole of Hong Kong (509 MWh/yr.), which would theoretically require numerous waterwheels to achieve.

9.4 TIDAL AND WAVE POWER

The ocean can produce mechanical energy from the tides and the waves. Tides are driven primarily by the gravitational pull of the moon, and waves are driven primarily by the winds. As a result, tides and waves are intermittent sources of energy which can be used to generate electricity by mechanical devices.

9.4.1 TIDAL POWER

Tides are created by the gravitational attraction of the moon and the sun acting on the oceans of the rotating earth, which causes the oceans to be raised and lowered periodically, according to a number of interacting cycles. It is one of the most predictable forces of nature. Water level rises during flood tides, and falls during ebb tides, a fluctuation which occurs approximately twice each day, or more precisely twice for every 24.84 hours, the period of the rotation of the moon around Earth. The difference between the consecutive high and low water levels is called the tidal range. The water head level difference due to tide can be captured and later released through turbo-generator to produce electricity. An impression of the tidal power is given in the Australian Renewable Energy Website and is reproduced in *Figure 9-6*.

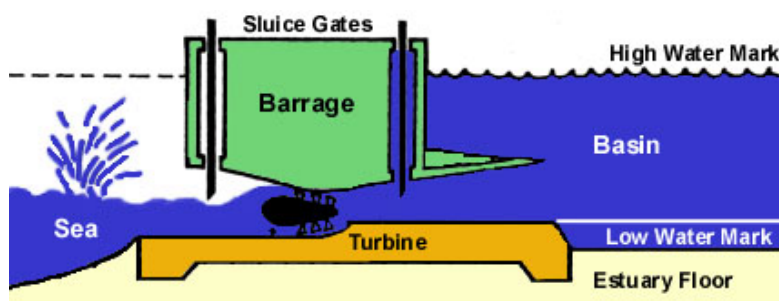

Figure 9-6: Impression of Tidal Power
(Source: Australian Greenhouse Office)

9.4.1.1 *The Capture and Conversion of Tidal Power*

Tidal power is captured by means of a barrage or dam built across an estuary to form an impounded basin. During floods, water will fill an impounded basin via a series of sluices which are then closed, creating a water level difference, or head of water with respect to the ebbing water seaward of the barrage. When the water level at the seaward side reduces further and the head is increased to a more substantial level, electricity is generated by releasing the water stored in the basin through a series of conventional bulb turbines, typically Kaplan turbines which will in turn operate generators. Large machines, as large as 8 metres diameter, are usually needed to produce sufficient output for relatively low head differences across a tidal barrage. This mode of generation where electricity is produced during the ebb tide period is called the “ebb-generation”.

Barrage can, in fact be built to allow power generation from both flood and ebb tide modes, made possible by modern turbine technology, namely, the “double-effect” turbo-generators. The two-way generation will improve the load factor of the power plant, two power generation cycles compared with only one for the one-way generation mode. However, due to the need to operate the sluices sooner near the end of tide turns, less energy could be stored in the barrage for later power generation in the two-way generation systems than in the one-way generation system. The “double-effect” turbines will also be less efficient than the single-effect ones. Two-way generation may not therefore produce more output than one-way ones.

9.4.1.2 *Status of the Technology*

Tidal Power Developments

The La Rance Station in France (*Figure 9-7*) is the only industrial-sized tidal power station in the world. It is a 240 MW power station inaugurated in 1966 and has been successfully running. It is equipped with twenty-four 10 MW units operating with 8.5 m tides. They are designed for double-effect operation.



Figure 9-7: La Rance 240 MW Station in France
(Source: Australian Greenhouse Office)

A number of small plants have been installed along the coast of China for multi-purpose application. In Jiangxia, Zhejiang Province of China, a rockfill dam was built in 1980 which was later altered to incorporate a tidal power plant capable of two-way generation with a tidal range of 5m. Elsewhere in Russia a small 400 kW facility was built near Murmansk which was later followed by a 17.4 MW experimental device built in Nova Scotia, Canada. The data

available from Johansson (Johansson et al, 1993) for overseas tidal power plant is summarised in Table 9-3.

Table 9-3: Summary of Overseas Tidal Plants

	Mean tidal range (m)	Basin area (km ²)	Installed capacity (MW)	Approximate output (GWh/yr)	In service
La Rance, France	8.0	17	240.0	540	1966
Kislaya Guba, Russia	2.4	2	0.4	-	1968
Jiangxia, China	7.1	2	3.2	11	1980*
Annapolis, Canada	6.4	6	17.8	30	1984

Note: * First unit in 1980, sixth in 1985

A number of other sites have also been studied worldwide for tidal power development. The Bay of Fundy of Canada, with very high mean tidal ranges above 10 m, has been recognized as the site with potential tidal power development. The Severn Estuary of the United Kingdom has been identified to be capable of installing 126 x 40 MW tidal power generating units. The Graolim Bay of Korea, Gulf of Kachchh in India, and Conway in North Wales are sites having mean tidal range of about 5 m with significant tidal power potentials. These investigations on the possible use of tidal power have not progressed further, however, largely due to economics.

Indicative costs

Tidal power projects require very high initial capital expenditure mainly due to civil works, which typically occupy 70% of the project cost. From the European Union data, the capital cost is estimated to be 2,300 ECU/kW at 1990 price which is obviously very site specific and is dependent on the size of the power plant.

In 1991 a study was commissioned by the EC to estimate the tidal energy potential of the EC which could be produced from barrages across estuaries. The study concluded that a technically feasible resource of 105.4 TWh/yr (from 64 GW installed capacity) was available, but only 51.8 TWh/yr would be available below 0.071 ECU/kWh at 1991 prices at 5% discount rate.

Tidal power projects require relatively long construction periods and hence will pose considerable risk to investment. As there are only two tides each day, tidal power generation facilities will have very low load capacity factors hence leading to long payback periods. Consequently, the unit cost of generation is highly sensitive to the discount rate used and project financing is uneasy. This may also explain for the almost complete lack of progress in tidal power development after the successful operation of La Rance Power Station in 1960s', and despite that the technology is well proven.

Site and Environmental Constraints

As mentioned previously, tidal power system will normally require the construction of a barrage or dam across an estuary. The environmental impacts associated with this would be on the positive side, the barrage protecting the coastline from storm surge tides, but the negative side, the changes in water levels which would modify currents, sediment transport and deposit, and estuarine ecosystem.

Therefore, it is important that any such structure could be designed to allow life, movement and reproduction of the species living in the water. Substantial physical or numerical modelling will be required to ensure that the significant change in flow velocity due to tidal power production will be acceptable.

9.4.1.3 Resource Assessment

Tidal Data

There are two tides each day and tidal levels are available from the Hong Kong Observatory for eight recording stations. To facilitate the calculation of tidal power resources, the 1999 tidal data are obtained. The data contain two pairs of high and low water levels for each day for each station and the corresponding time of occurrence. These data are processed and can be summarised as follows:

Table 9-4: Summary of 1999 recorded tidal data

Station	% Data Captured*	Maximum Tidal Range (m)	Average of Daily Maximum Tidal Range (m)
Shek Pik	77.81	2.56	1.30
Tsim Be Tsui	52.33	2.90	1.75
Lok On Pai	37.81	2.58	1.39
Quarry Bay	80.00	2.37	1.26
Tai Po Kau	69.59	2.38	1.36
Tai Miu Wan	60.00	2.02	1.14
Waglan Island	34.52	1.91	1.11
Average	58.87	2.39	1.33

Note: * % Data Captured = $100 \times (\text{number of days in which complete data are available}) \div 365$

The maximum tidal range is observed to be 2.9 m with an average of 1.33 m.

9.4.1.4 Calculation of Tidal Power Resource Potential

As discussed above, tidal energy is stored by means of an impounded basin and later released through turbines. The larger the impounded basin is, the more energy can be stored due to tidal level changes.

Theoretically, every metre of water level difference due to tide can produce a head convertible to power. For a constant cross-section area impounded water basin with a constant water level difference of H metres, the potential energy available from the water basin will be $4.91 H^2$ kJ/m². The constant H assumption implies that this is the theoretical maximum upper bound estimation for the tidal energy resources potential.

With the above formula and the 1999 tidal data recorded from the various stations, the theoretical maximum tidal energy which can be produced per day per unit area of an impounded water basin have been calculated as given in *Table 9-5*.

Table 9-5: Tidal Resource Potential

Station	Theoretical Maximum Tidal Energy (kJ/m ²)	
	Annual Total	Daily Mean
Shek Pik	4,782	13.10
Tsim Be Tsui	8,640	23.67
Lok On Pai	5,335	14.62
Quarry Bay	4,402	12.06
Tai Po Kau	4,859	13.31
Tai Miu Wan	3,557	9.75
Waglan Island	3,397	9.31
Average	4,996	13.7

It is seen that the average tidal energy resource potential for Hong Kong will be less than 13.7 kJ/m²/day or 1.39 kWh/m²/yr. The amount of energy available for tidal power generation is dependent on the size of the impounded basin that could be built. Nevertheless, the calculated upper bound resource potential per unit area is seen to be extremely small when compared to other NRE resources.

9.4.1.5 Options Evaluation

Preliminary Options

Suitable sites would entail an estuary upon which a barrage or dam can be constructed across. Obviously, there are other factors that need to be considered such as potential ecological impacts, coastal utilisation, foundation and water depth conditions.

Examining the geography of Hong Kong, the Tolo Harbour is seen to be the most optimum location that will allow the minimum amount of effort to build a dam across its mouth to form a basin with maximum water storage for possible tidal power generation. The electricity generated can be connected into the existing power grid for transmission and distribution to consumers. This option is shown in *Table 9-5* and its resources potential is evaluated in the next section.



Figure 9-8: The Impounded Basin Option at Tolo Harbour

Options Evaluation

For the basin formed as per *Figure 9-8*, the total area of the basin is calculated to be approximately 45.5 km². The tidal energy potential for Hong Kong is 13.7 kJ/m²/day as derived. Assuming that the basin area is approximately unchanged with change in water depth (due to large surface area and the small tidal water level changes), the maximum possible energy potential available from tidal water level change would be:

$$13.7 \times 45.5 \times 10^6 \text{ kJ/day} = 623,000 \text{ MJ/day or } 173 \text{ MWh/day}$$

Taking a turbine efficiency of 85% for hydraulic turbines (80 – 90% as reported by Binder, R.C., 1962), and a further loss of, say 3% in electrical generator and mechanical transmission, the maximum possible electricity from the conceptual tidal power installation would be 514,000 MJ/day. This can be translated to 143 MWh/day or 52 GWh/yr. Comparing with the total power consumption of 35.5 TWh in 1999, the maximum possible tidal energy from the conceptual tidal power station in Tolo Harbour would be 0.15% of the total power consumption in Hong Kong.

However, this is the theoretical maximum tidal energy that can be harvested from the possible option. As shown in *Table 9-4*, the mean tidal range in Hong Kong is 1.33m, with a maximum of 2.9 m recorded on one day in 1999. These are less than the generally recognised exploitable tidal range of 3.0 m (Johansson et al, 1993). This can be illustrated from the data available from Johansson (Johansson et al, 1993) for overseas tidal power plants, as shown in *Table 9-3*.

As the plant could generate a maximum only two times per day, the capacity factor of the plant will be extremely small, i.e. small plant utilisation factor which may lead to long energy payback time.

Tolo Harbour is recognised to have high recreational and ecological values as suggested in the Territorial Development Strategy Review. There are several environmental and associated constraints that must be addressed prior to development a tidal power scheme in the area. These include:

- ❑ Modification to tidal flow regime in and around the harbour;
- ❑ Short term water quality impacts during construction of the barrage or dam (e.g., sediment dispersion during dredging);
- ❑ Long term water quality impacts induced by changes in the flow regime (e.g., sediment deposition and scouring equilibrium). As Tolo Harbour is a topographically confined basin, any changes to the natural tidal flushing pattern will be of particular concern;
- ❑ The combined effects of water flow and quality changes on sensitive ecological receivers in and near the harbour, including for example, corals, seabird roosting sites, and two marine parks (see *Figure 9-8*); and
- ❑ Impacts on beneficial uses of the harbour including beaches, navigation, anchorage, and commercial fisheries (both culture and capture fisheries).

9.4.1.6 Conclusion

Tidal energy is harvested by means of a barrage or dam built across an estuary to form an impounded basin. The larger the basin, the greater tidal energy potential it can generate. Based on tide data from the seven recording stations of the Hong Kong Observatory, it is estimated that the mean tidal energy resources potential in Hong Kong is 13.7 kJ/day per m² of the impounded basin.

An option of building a dam across the Tolo Harbour to harvest the tidal energy has been formulated. The Tolo Harbour site will allow minimum amount of effort to build a dam across to form a basin with maximum water storage for possible tidal power generation. Calculation shows that the conceptual tidal power plant will generate electricity less than 0.15% of the total power consumption in Hong Kong.

Constraints on the possible tidal power plant development will be modification to tidal flow regime and impacts on water quality, marine and inter-tidal ecology, marine parks, waterway use, fisheries and recreation (beaches).

In view of the negligible resources potential in Hong Kong and the likely constraints, tidal power is not seen to be a priority for further pursuit at present stage.

9.4.2 WAVE

Waves are created by the interaction of winds with the sea surface, and have both kinetic energy in the forward movement of water, and potential energy due to the amount of water displaced from the mean sea level. The highest concentration of wave energy occurs between 40° and 60° latitudes, in each hemisphere. This is due to the prevailing trade winds. Wave energy devices interact directly with waves and use the energy of the waves in conjunction with electrical generators or turbines, either with direct impact or induced movement of air, to operate the turbines in producing electricity. The requirements of effective power generation for wave energy are high waves, and adequate wave speed of sufficient duration, which will also be site specific.

9.4.2.1 The Capture & Conversion of Wave Power

The earliest work on wave energy system is probably the utilisation of rise and fall of water surface to provide compressed air to drive a turbine. The small turbine placed on a buoy to generate electricity for navigation lights was developed in 1960s. Nowadays, wave power generation technology can be classified as:

- *Oscillating water column* (Figure 9-9) which generate electricity from the wave-driven rise and fall of water in a cylindrical shaft or caisson. The rising and falling water column drives air into and out of the top of the shaft, and in turn power an air-driven turbine, which can drive a generator to produce electricity. Hence this is sometimes called a pneumatic system.

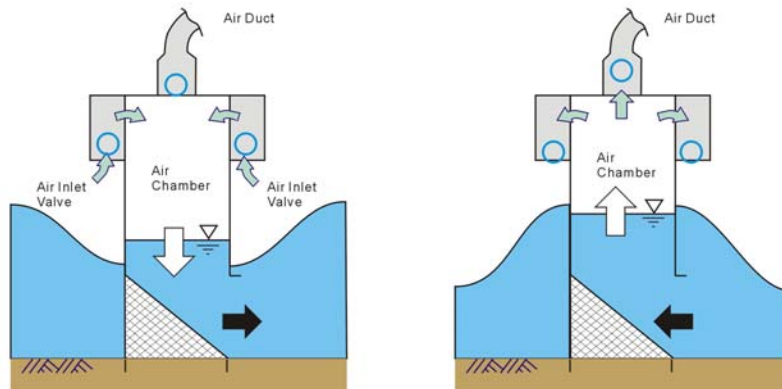

Figure 9-9: An Oscillating Water Column Energy Wave Energy Recovery Device
(Source: Itagemen 1992)

- ❑ *TAPCHAN*, or *tapered channel systems* (Figure 9-10) consisting of a tapered channel (hence the name TAPCHAN) to channel and concentrate the waves into an elevated reservoir. The narrowing of the channel causes the waves to increase their amplitude (wave height) as they move towards the elevated reservoir which would eventually spill over the walls of the channel and into the reservoir positioned several metres above mean sea level. The kinetic energy of the moving wave is converted into potential energy, as the water is stored in the reservoir. The stored water is then fed through Kaplan turbine and produce electricity as in standard hydropower technologies.

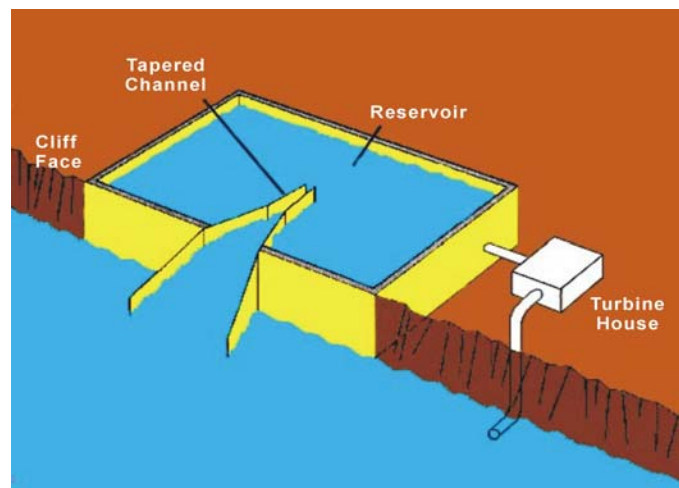

Figure 9-10: TAPCHAN System
(Source: Australian Greenhouse Office)

- ❑ *Floating devices* (Figure 9-11) which employ the harmonic motion of the floating part of the device to produce energy. In these systems, the floating object can be mounted to a floating raft or to a device fixed on the ocean floor. The rise and fall of the floating object according to the motion of the wave produce a motion that could generate electricity directly or drive a seabed mounted piston or hose pump, which in turn could operate a turbine and generator to produce electricity indirectly. In general, it is important to have relatively precise knowledge of the wave characteristics for effective

capture of the wave energy in any location.

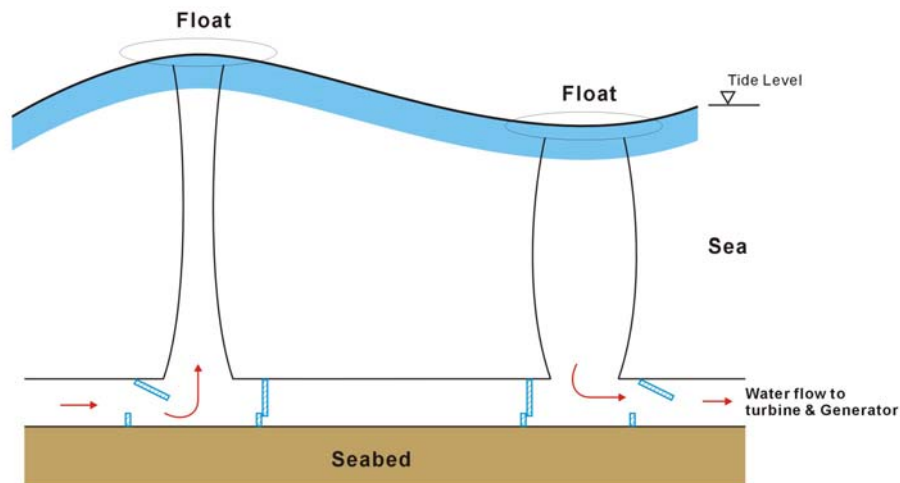

Figure 9-11: Hose Pump Operating Principle

9.4.2.2 Status of the Technology

Wave Power Developments

Most of the wave energy devices as mentioned above remain at the research and development stage. They have been developed or tested for driving water pumps, navigation buoys, calming inshore waters for mariculture, etc. as well as electricity production. Powering navigation buoys can be said as the only proven wave energy to electricity device.

Information from the European Union suggests that the largest unit built in the world is probably the 500 kW unit which is a shoreline pilot oscillating water column unit in Portugal. An earlier unit, which is also a shoreline 500 kW oscillating water column unit, was installed in Norway in 1985 but was destroyed in a storm three years later. The next size of wave energy unit is a 350 kW TAPCHAN demonstration unit installed in Norway in 1985. It was, however, destroyed in early 1990s due to modification work later. There have been other experiments of scale of the order of tens of kW in various countries reported by Carmichael and Falnes (1992) and European Union, such as the 75 kW oscillating water column unit in Scotland, the 30 kW oscillating water demonstration unit at Kujukuri in Japan, the 45 kW piston pump unit in Denmark, and hose pump prototype testing in Sweden.

Indicative Costs

Initial capital investment as reported by Hagerman (1992) is also high, ranging from US\$1,600 - 7,300/kW at 1990. This initial capital investment was based on wave energy equipment size, ranging from a unit for an oscillating water column of a 0.5 MW capacity, and a unit for an oscillating water column of a 1.5 MW capacity, respectively. The cost of wave power is undoubtedly site specific. For instance, the site preparation cost for TAPCHAN system will depend greatly on shoreline geology and topography. Additional cost will be needed for connection to existing power grids for offshore devices. For the North Atlantic, when the wave power is 50 kW/m, the cost of electricity is US\$9.23/kWh, assuming 12.5% discount rate and excluding submarine cable costs (Cavanagh et al, 1993). However, there are considerable

uncertainties in the economics of wave energy as the technology is not yet fully established and data are limited.

Site And Environmental Constraints

Apart from wave-powered navigation buoys, most wave power devices are placed at or near the shore. These on-shore devices must be able to reconcile with coastline utilisation. Careful considerations have to be made to avoid unacceptable impacts on marine life and shoreline, degradation of scenic sea fronts, conflicts with marine parks or site of scientific interests in Hong Kong.

For TAPCHAN system, special considerations must be given to ensure that modification to natural water flow, sedimentation will not cause unacceptable impact to the local ecology. Environmental considerations for TAPCHAN system will be similar to those for hydroelectric or tidal power.

For offshore devices, they must not interfere with marine shipping activities, mooring or anchorage lines with commercial and sport-fishing. Possible marine hazards will need to be carefully studied as wave energy devices are low above water, making them undetectable either by radar or sight. Connection of the power generated by the offshore devices into existing electricity grids will also be a major issue as well increased maintenance and service costs.

In Hong Kong, the greatest waves will be found in the southern part of the territory where the sea is relatively un-sheltered. The most suitable locations for wave energy recovery devices should be found in these areas. Very special attention will need to be given for any possible siting of inshore or near shore wave power plant with regards to visual, ecological, land and marine use. Siting an offshore wave power plant will also require careful considerations on the possible marine hazards and connection to grid. Wave energy recovery systems are also prone to damages due to storms if they are not suitably designed.

9.4.2.3 Wave Energy Resource In Hong Kong

Calculation of Wave Power Resource Potential

As mentioned above, wave energy is composed of both potential and kinetic energy. Combining the potential and kinetic energy together, the ideal total energy per wave will be:

$$\rho g H^2 L / 8 \text{ per width or } \rho g H^2 / 8 \text{ per area}$$

where, ρ is the water density

H, the wave height (the vertical distance from wave trough to wave crest)

L, the wave length, or length of a wave front

Actual waves can be considered to be a combination of a series of sinusoidal waves. Therefore, the actual energy will be smaller than those derived above as actual waves are not dissipative due to friction as contrast to the non-dissipative assumption used in the derivation.

Resource Potential in Hong Kong

Wave data collected by Hong Kong Observatory at Waglan Island for the year 1999 have been collected for calculating of the power potential from wave in Hong Kong. Based on the above formula, the total wave energy is thus estimated to be 27,600 MJ/m for the year 1999, with a daily average of 79 MJ/m. These can be translated into an energy density of 374 MJ/m² for the year 1999 and an annual average energy density of 1.06 MJ/m². It is very small even when compared to other NRE technologies (such as solar where the annual average energy potential is about 13 MJ/m²/day). Furthermore, only a fraction of this can be converted into electricity taking account of friction and machine irreversibilities. A total conversion efficiency of wave energy to electricity of 35% has been reported by Carmichael and Falnes (1992) for a wave energy driven pneumatic system. This would imply that a 10 kW of installation (to power a small home of 300 kWh of electricity per month) will take up about 35 m of shoreline.

9.4.3 Conclusion

Most of the wave energy developments are still at desktop stage without full scale testing at sea. It is seen that wave energy devices for sizeable electricity generation is far from fully established in Europe, neither will be promising in United States as also suggested by California Energy Commission, despite that wave energy potential will be greatest at these locations between 40° and 60° latitudes.

It is concluded that electricity from wave energy is considered not suitable for large-scale community use in Hong Kong at present. However this may be the technology worth considering in future when wave power generation technology become more established and found to be suitable for deployment in Hong Kong. Very detailed measurement of wave will then be needed.

9.5 GEOTHERMAL ENERGY

9.5.1 TECHNOLOGY IDENTIFICATION

9.5.1.1 Introduction

Geothermal energy is the natural heat extracted from the earth's crust. The energy is in the form of heat, which originates deep in the earth's molten interior. This heat energy is responsible for tectonic plates, volcanoes and earthquakes. It is a substantial resource, which has not yet been developed to its full potential, primarily due to the high costs involved compared to conventional sources.

The presence of geothermal energy is apparent in places where the earth's heat dissipates into the atmosphere through a carrier fluid, such as the warm waters that flow from geysers and spas, or through the release of hot gases or volcanic eruptions. The temperature in the earth's interior is as high as 7000°C, decreasing to 650 - 1200°C at depths of 80 - 100 km. Through the deep circulation of groundwater and the intrusion of molten magma into the earth's crust to depths of only 1 - 5 km, heat is brought closer to the earth's surface. The hot molten rock heats the surrounding groundwater, which is forced to the surface in certain areas. The simplest and most cost-effective approach would be to tap directly to these heat sources, to harvest the energy. This however, is very location dependent, as not all locations have these readily available heat sources.

Another alternative would be to extract the heat at depth. The deeper into the earth's crust, the higher the pressure, and greater the heat. The temperature increases at an average rate of 30 to 35 °C/km. The limit to this type of exploration, due to mainly economic reasons, is at about a depth of 5 kilometres. This type of energy can be used in different ways to generate electrical energy. Certain zones characterised by active tectonic movements, along with numerous local lithologic and hydrological factors, which contribute to highly conductive heat flows, render the zone suitable for geothermal exploitation.

Currently, the USA is the largest producer of geothermal electricity, with an installed capacity of 2,850 MW at 1998 (about 35% of world total). The Geysers Field in California is the largest producing geothermal facility in the world. It produces about 1,300 MW of electricity, which is enough to satisfy the residential needs of about 1.7 million people in California. The next largest producers of geothermal power are Italy (769 MW), Mexico (743 MW), Indonesia (590 MW) and Japan (530 MW). New Zealand, while not as large in terms of production capacity (345 MW), derives 75% of its energy requirements from geothermal sources.

9.5.1.2 Geothermal Resources

There are four types of geothermal resources: hydrothermal, geopressured, hot dry rock and magma. Currently, only hydrothermal resources are commercially exploited, as the other technologies identified, are not considered mature, and hence, still in development.

Hydrothermal

Hydrothermal resources arise, when hot water and/or steam is formed in fractured or porous rock at shallow to moderate depths (100 m to 4.5 km). This can be a result of either an intrusion in the earth's crust of molten magma from the earth's interior, or the deep circulation of water through a fault or fracture. High temperature hydrothermal resources, with temperatures from 180°C to over 350°C, are usually heated by hot molten rock. High-grade resources are usually used for electricity generation, while low-grade resources are used in direct heating applications. Figure 9-12 shows a schematic diagram of how the geothermal/hydrothermal energy can occur.

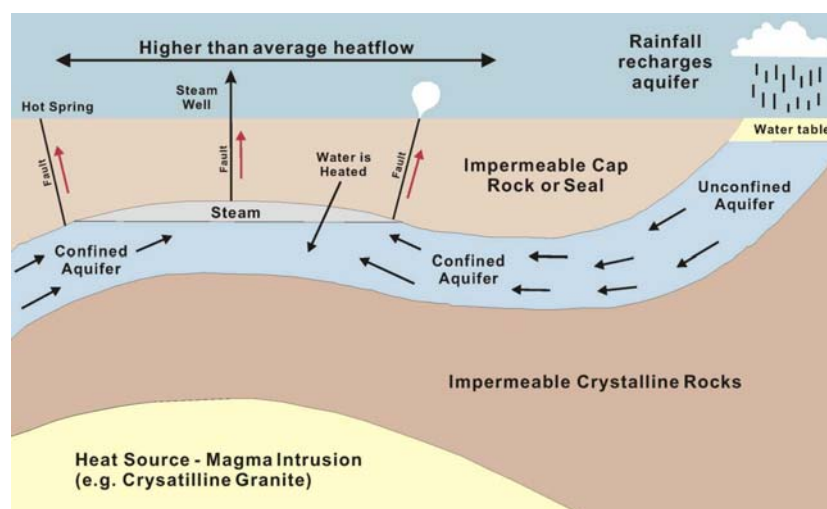

Figure 9-12: Geothermal/Hydrothermal Resource

Hydrothermal resources require three basic components, a heat source, such as, crystallised magma, an aquifer containing accessible water, and an impermeable cap rock to seal the aquifer. The geothermal energy is usually tapped by drilling into the aquifer, and extracting the hot water or steam.

Geopressured

Geopressured geothermal resources consist of hot brine saturated with methane, found in large, deep aquifers under high pressure. The water and methane is trapped in sedimentary formations at a depth of about 3 – 6 km. The temperature of the water is in the range of 90 - 200°C. Three forms of energy can be obtained from geopressured resources: thermal energy, hydraulic energy from the high pressure and chemical energy from burning the dissolved methane gas.

Hot Dry Rock

“Hot dry rock” is a heated geological formation formed in the same way as hydrothermal resources, but containing no water as the aquifers or fractures required to conduct water to the surface are not present. Under certain geological conditions, e.g. existence of young volcanoes or abundant high heat-producing granite rocks and sedimentary layers with insulating properties overlying these localised heat sources, the subsurface rocks of granite type can reach temperatures of 200 - 300°C within five kilometres of the surface.

Thermal energy stored in these hot rocks is harvested by injecting cold water at injection well bores. Thus, into Hot Dry Rock reservoirs, where an interconnected fracture network has been developed by stimulation, and producing hot water at production wells.

Magma

Magma, the largest geothermal resource, is molten rock found at depths of 3 – 10 km and deeper, and therefore it is not easily accessible. It has a temperature, which ranges from 700 - 1,200°C. The aim of a magma system is to extract heat by tapping into the magma chamber. Theoretically, fluid can be circulated in the top part of the magma chamber, which creates in effect a “downhole” heat exchanger. The heat will then power a closed Rankine-type cycle to generate electricity. This technology is still in its early development stages.

9.5.1.3 Geothermal Technology

Geothermal energy can be utilised directly or in the generation of electricity. The direct use of geothermal energy are the applications associated with using the direct heat or steam from the hydrothermal resources. These applications include, space heating, water heating, greenhouse heating, aquaculture, laundries and industrial processes.

Direct-use geothermal systems are typically comprised of a production facility, a mechanical system, and a disposal system. The production facility such as a well or borehole, delivers the heated water to the surface. The mechanical system, such as pipes, heat exchanger, pump and controls, are required to transport the energy to the direct use application. The disposal system is required to receive and store the cooled fluid. These are typically storage ponds or injection wells.

Geothermal energy can also be directly used by means of geothermal heat pumps. The device uses the relatively constant temperature of the earth's interior and uses it as either a heat source or a heat sink, thereby, providing for heating and for cooling.

The generation of electricity uses the geothermal resources at high temperatures and a number of energy conversion technologies. These include dry steam, flash steam, binary cycle systems, and hot dry rock technology. Geothermal electricity can be used for base load power, as well as for peak load demand.

Dry Steam Technology

The dry steam power plant is suitable where the geothermal steam is not mixed with water. Production wells are drilled down to the aquifer and the superheated, pressurised steam (180 - 350°C) is brought to the surface at high speeds, and passed through a steam turbine to generate electricity (see *Figure 9-13*).

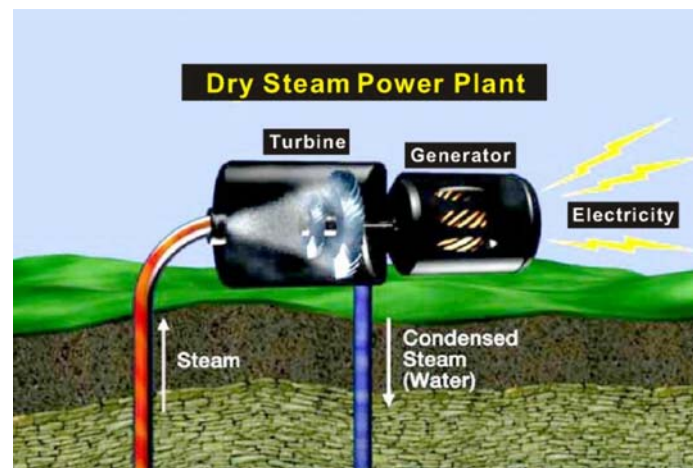

Figure 9-13: Dry Steam Power Plant
(Source: Geothermal Education Office, California, USA - website)

The waste heat is vented through cooling towers. The energy efficiency is around 30%, as the efficiency of the dry steam plants are affected by the presence of non-condensable gases such as, carbon dioxide and hydrogen sulphide, which reduces the efficiency of the turbines. Dry steam power plants are the simplest and most economical technology and therefore are widespread. The units commercially available range from 35 to 120 MW.

Flash Steam Technology

Single flash steam technology is used where the hydrothermal resource is in a liquid form. The fluid is pumped and sprayed into a flash tank, which is kept at a much lower pressure than the fluid. This causes the hydrothermal fluid to vaporise or "flash" rapidly into steam. The steam is then passed through a turbine coupled to a generator for electrical energy production. To prevent the geothermal fluid flashing inside the well during extraction, the well is kept at a high pressure (see *Figure 9-14*).

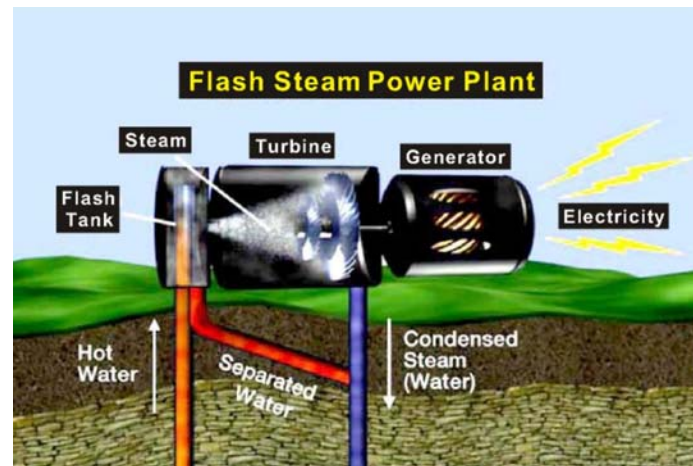

Figure 9-14: Flash Steam Power Plant

The majority of the geothermal fluid does not flash. This fluid is re-injected into the reservoir or used in a local direct heat application. Alternatively, if the fluid remaining in the tank has a sufficiently high temperature, it can be passed into a second tank, where a pressure drop induces further flashing to steam. This steam, together with the exhaust from the principal turbine, is used to drive a second turbine or the second stage of the principal turbine to generate additional electricity. Typically, a 20 - 25% increase in power output can be achieved, with only a 5% increase in plant costs. Flash steam plant generators size range from 10 to 55 MW.

Binary Cycle Power Plant

Binary cycle power plants are used where the geothermal resource is insufficiently hot to efficiently produce steam, or where the resource contains too many chemical impurities to allow for flashing. In addition, the fluid remaining in the tank of flash steam plants can also be utilised in binary cycle plants.

In the binary cycle process, the geothermal fluid is passed through a heat exchanger. A secondary fluid, which has a lower boiling point than water, such as isobutane or pentane, is vaporised, and expanded through a turbine to generate electricity. The working fluid is condensed and recycled for another cycle. All of the geothermal fluid is reinjected into the ground in a closed-cycle system (see *Figure 9-15*).

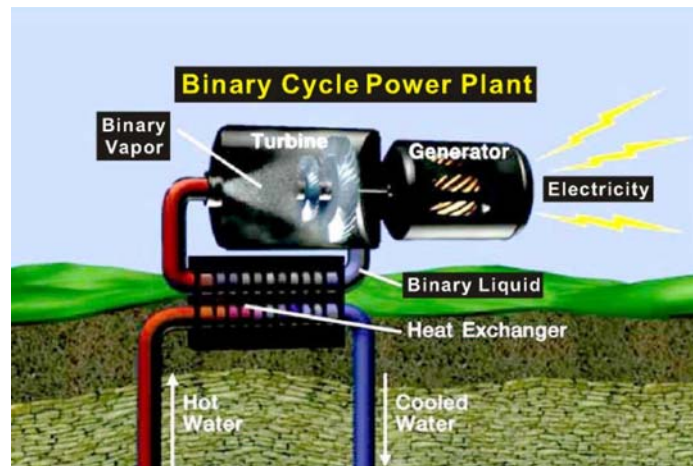

Figure 9-15: Binary Cycle Power Plant

Binary cycle power plants can achieve higher efficiencies than flash steam plants, and they allow the utilisation of lower temperature resources. In addition, corrosion problems are avoided. However, binary cycle plants are more expensive. The use of large pumps consumes a significant percentage of the power output of the plants. The unit sizes are typically in the range of 1 to 3 MW.

Hot Dry Rock Technology

The geothermal technology associated with hot dry rocks is the development of an artificial geothermal reservoir by drilling deep twin wells into the “hot” rock, or rock at a usable depth, and then forming a large heat exchange system by hydraulic or explosive fracturing. Water is circulated down the injection well through the created reservoir (which heats the water), and then up the production wells. A binary cycle system can then be used to generate electricity. This technology, however, remains “under development”.

9.5.2 DEPLOYMENT ISSUES

9.5.2.1 *Determining Geothermal Energy Resource Potential*

The geological conditions necessary to create a geothermal resource exist in very few parts of the world, most often along the Pacific Rim. In these areas, deep fractures occur in the earth’s crust, and molten material or magma is pushed close enough to the surface to heat geothermal reservoirs. Evidence of such activities may be seen by physical occurrences such as volcanoes, hot springs, and geysers. The areas with the greatest potential for geothermal electrical power production are indicated in *Figure 9-16*.

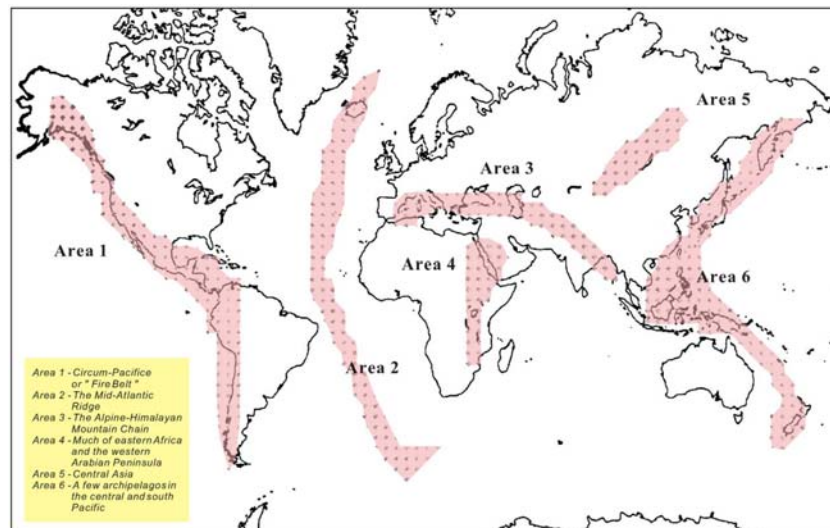

Figure 9-16: Regions of High Geothermal Potential

There are six regions where total heat flow and the concentration of geothermal energy are highest:

Area 1 - Circum-Pacific or "Fire Belt"

Area 2 - the Mid-Atlantic Ridge

Area 3 - the Alpine-Himalayan Mountain chain

Area 4 - much of eastern Africa and the western Arabian Peninsula

Area 5 - Central Asia

Area 6- a few archipelagos in the central and south Pacific.

All the regions coincide with discontinuities in the earth's crust. The regions are very active tectonically, experiencing frequent and often severe seismic activities. These six regions have the highest energy concentration, with the potential for geothermal exploitation. It should, however, be noted that the potential refers only to the exploitation of hydrothermal reservoirs that have an average depth of less than 2 km. At depths beyond 2 km, it starts to become less economical for most countries to develop.

To determine the resource potential of an area, there are several initiatives, which must be undertaken to ensure that there is a definite potential in a site, because the cost involved in geothermal energy extraction can be quite substantial. Prior to the costly initial investment into geothermal exploration, an investigation into the regional geology and geological history, and a geochemical analysis should be done, to eliminate unsuitable locations. Once the initial study areas have been used to screen the sites, the remainder can undergo a number of exploratory drillings. The drillings also involve substantial financial costs, but are necessary. This is called the feasibility phase, and typically a minimum of two to a maximum of six or seven, wells are drilled to verify the existence of a geothermal reservoir and to determine the physical characteristics of the geothermal fluid. The depth of the exploratory drillings can vary depending on the intended use of the energy. For low to medium temperature direct

uses, shallow drillings are sufficient for investigation, i.e., less than 2,000 m. For geothermal-electric production, the drilling depths are typically greater than 2,000 m.

9.5.2.2 *Siting and Environmental Issues*

When determining the location of a geothermal energy facility, not only should the availability of the resource be examined, but the environmental and visual impacts must also be taken into account. Geothermal energy must be used in situ to produce electricity, and because of this, the locality is important.

The environmental impacts can be in the form of noise and air emissions. The temporary environmental impacts are related to the exploitation and drilling, such as noise and dust. The permanent environmental impacts can result from well maintenance, and power plant operations, such as cooling tower plumes, noise, release of gaseous pollutants (H_2S , CO_2 , radon, etc.) and toxic elements, such as mercury and arsenic (although only present in trace quantities), solid waste and residual water disposal, micro-earthquakes, and subsidence. Some of the environmental impacts can be mitigated and controlled, such as residual water re-injection to control subsidence and micro-earthquakes, and scrubbers to control quality of emissions. Particularly, visual impacts such as an industrial facility and large cooling towers may not be suitable for urban areas, as it may not blend with existing urban landscape and architecture. Steam driven plants also emit heavy plumes of steam. Whilst relatively harmless, the plume does produce a visual impact (*Figure 9-17*).

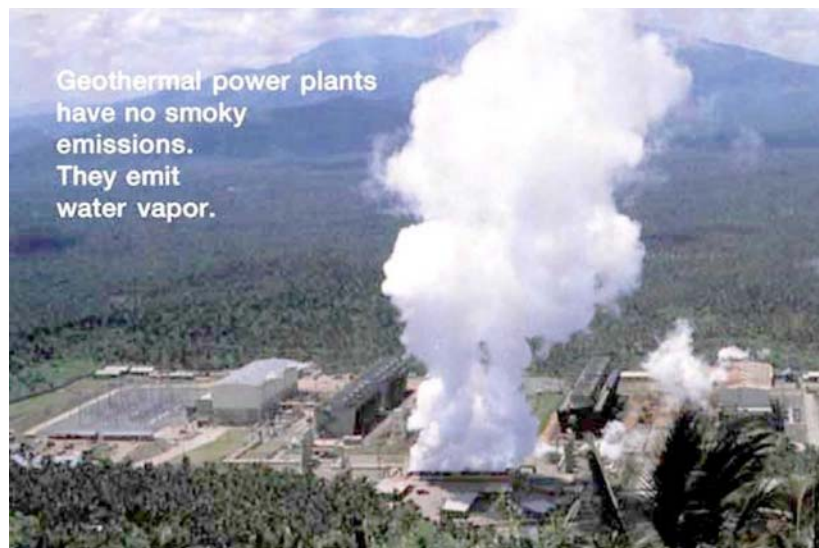

Figure 9-17: Steam Driven Geothermal Plant

9.5.2.3 *Assessment of Hong Kong Conditions*

Geology

The geology and subterranean features of Hong Kong are very indicative tools for assessing the possible geothermal potential. Mesozoic volcanic and intrusive igneous rocks dominate the solid geology of Hong Kong. This may initially suggest that Hong Kong may have high potential for geothermal activities, such as magma intrusion or heating of confined aquifers.

Indeed, the area of Hong Kong was highly volcanic at one point in its history, but the volcanic material that the geology of Hong Kong is mainly comprised of, dates back 65 to 200 million years, with very little that is later in age. This suggests that there has been no major volcanic activity since the Mesozoic Age.

Seismic activity such as earthquakes normally occurs along the boundaries of crustal plates. Hong Kong is situated within the Eurasian Plate, but is not close to the boundaries. The nearest boundary is with the Pacific Plate on the Circum-Pacific Seismic Belt, which runs through Japan, Taiwan, and the Philippines, this boundary is about 600 km away. Therefore, the probability of a major local tremor in Hong Kong is very small (*Hong Kong Observatory – Seismology Department web page*).

Information from the Hong Kong Geological Survey – Geological Map of Hong Kong, Memoir No. 2 (see *Figure 9-18*) shows many faults exist in the region around Hong Kong. A statistical analysis done by the Hong Kong Civil Engineering Department, Geotechnical Engineering Office, on trends which includes the logical extrapolation of geological features (faults and photolineaments) beneath superficial deposits concluded that it has found no evidence of active faults within the Hong Kong district. The details of Hong Kong fault zones are presented in the Hong Kong Geological Survey – Memoir No. 2. Therefore, the geology of Hong Kong also suggests that Hong Kong is not a geothermally active area.

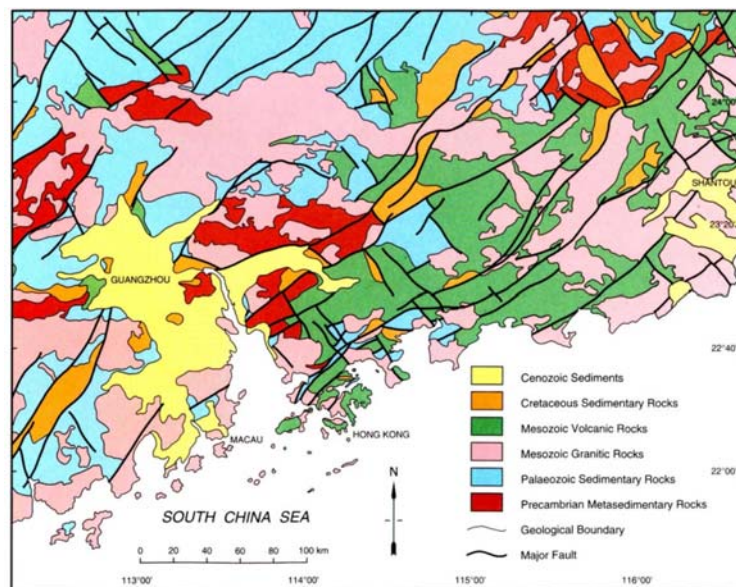

Figure 9-18: Regional Geological Map

Lastly, evidence that suggests that Hong Kong is not a geothermally active area, is the absence of physical occurrences such as volcanoes, hot springs, and geysers. This also means that hydrothermal resource, the only commercially exploitable geothermal energy source is not available in Hong Kong.

Siting, Environmental and Costs Issues

As mentioned earlier, geothermal energy has to be utilised in-situ to generate electricity in a centralised power station. It is likely that the size of a centralised geothermal power station would be similar to a conventional fossil fuel (e.g. natural gas) power plant of similar capacity,

as similar sized electricity generation equipment would be involved. Therefore, even if geothermal resource were available, siting of a large geothermal power plant would be problematic in Hong Kong due to intensive competition for developable land. Also geothermal power plants could also cause environmental impacts (e.g., visual, ground subsidence, and air emissions), making it unsuitable for location in or close to developed urban areas, and areas of conservation interest (e.g., country parks).

Further, the cost of developing geothermal energy sources is substantial. Given the geological data suggests that Hong Kong does not have an apparent geothermal resource, geothermal development is therefore unlikely to be economically justifiable. Geothermal development is only cost-effective for areas with evident geothermal potential, as the initial exploratory costs are high.

9.5.3 CONCLUSION

Currently, hydrothermal resource technology is the only geothermal technology with a proven and established history. All other geothermal technologies are still in the developmental stage. Therefore, hydrothermal is the only technology that should be considered at this stage.

However, Hong Kong does not have a meaningful hydrothermal potential, as is evidenced by the absence of volcanoes, geysers, and hot springs. The location of Hong Kong with respect to major geothermal zones also suggests that Hong Kong does not have a ready geothermal potential. Geothermal energy is, therefore, not considered a viable renewable energy source for wide-scale adoption in Hong Kong.

9.6 INDEPENDENT ENERGY STORAGE SYSTEMS

9.6.1 INTRODUCTION

Renewable energy resources may be divided into two main categories according to their availability. Firstly, there are those constant and continuous resources, including for example, biomass crops, energy-from-waste and geothermal. Secondly, there are those that are variable or intermittent in nature, and these may be sub-categorised to those which vary periodically or cyclically such as solar and tidal, and those which vary rather randomly such as wind and waves.

Although many renewable energy sources will probably be used first for the direct production of electricity, the potential for renewable electricity is somewhat limited by the intermittent and fluctuating character of some of the resources (e.g., solar and wind). In extreme situations, the peak demand for electricity may coincide with low production of renewable power, or high output of renewable power phases with low demand.

This mismatch of supply and demand means that power generation facilities using intermittent renewable energy sources are best connected to the electricity grids (which serve to smooth out variations in renewable power supply) to ensure a cost-effective and reliable power supply to the users. This practice is already adopted in several overseas countries. For example, in the UK, solar and wind power are connected to the National Grid without serious technical difficulties, though the amount of renewable power is not significant (less than 10%) compared to conventional power. Given the extensive coverage of the two electricity grids in

Hong Kong, it is proposed that grid connected renewable power systems will also warrant serious considerations, as a means to promote wide-scale adoption of renewable energy systems.

However, in remote island applications or areas where conventional grid electricity is not available, renewable power generation systems often will have to assume an *independent energy storage system*, or a *hybrid* (i.e., multiple sources/technologies) arrangement with *energy storage*, if a reliable supply of electricity is to be provided. The use of multiple sources or technologies (e.g., solar and wind) aim to maximise the quantity of renewable power that can be generated, while a storage system is needed to buffer the mismatch between power supply and demand. The concept of an independent renewable energy system is discussed in the following sections.

9.6.2 CONCEPTS AND TECHNOLOGIES

9.6.2.1 Energy Storage Systems

Integral to all independent hybrid systems is an energy storage system. The storage system will permit excess electricity generated during the periods of high availability of renewable and low power demand to be transported and stored, and release later during periods of low resources availability and high power demand.

The apparent suitable choice for energy storage is battery storage. Battery storage can operate at high efficiency, around 75%, but it is capable in storing very small amount of energy (average load less than 50 kW). They have short lifetime and are generally very costly energy storage device. The world is therefore in search of other energy storage systems like flywheels, pressurised-fluid systems, hydrogen storage system. The hydrogen storage system has emerged as a very promising option for storing energy from NRE.

As an energy carrier and a storage medium, hydrogen is produced through water electrolysis with very high conversion efficiency, typically 70 - 94% when electricity production by renewable energy in excess of demands. The stored hydrogen can then be converted to electricity, through fuel cell as already discussed in Chapter 7. Typically, fuel hydrogen has a specific gravity of 0.07 and a calorific value of about 12 MJ/m³. The hydrogen can be stored in gaseous form, liquefied form or as a metal hydride.

Liquefied hydrogen is the highest energy content form of storage that is attractive and commercially available. However, the high capital costs of liquefaction and storage makes this option less favourable than compressed hydrogen. Moreover, more than 30% of the energy value of hydrogen is needed to liquefy gaseous hydrogen and "boil-off" of cryogenic liquid which cause the method to be the lowest storage efficiency among all other hydrogen storage technologies.

Hydride storage is a relatively compact storage with reasonable efficiencies, but is still very much in the developmental stage and is not likely to be widely available in the near future.

Compressed hydrogen appears to be the most favourable for stationary power generation applications. Compressed hydrogen can be stored underground or aboveground, similar to natural gas, or town gas. Imperial Chemical Industries has stored 95% pure hydrogen in salt mine caverns near Teeside in the UK. Standard high-pressure vessel can hold up to 250 m³ of

hydrogen at pressures of 80 to 500 bar and a spherical tank can store more than 15,000 m³ at 12 to 16 bar. Provided safety requirements are fulfilled, hydrogen storage is no more dangerous than other energy storage.

9.6.2.2 System Concept

While experience has been gained with many new and renewable energy systems, as reviewed in the preceding chapters of this report, some of the technologies are still under development and immature. As hybrid systems are essentially a combination of new or renewable energy resources and technologies, and many are only “concepts” at this stage, the *combined* efficiencies and costs of hybrid systems are generally unproven. Nevertheless, this section presents a concept for hybrid renewable power generation system utilising hydrogen storage, as shown in *Figure 9-19*. This concept may be applied to a remote area (e.g., an offshore island) where conventional grid electricity is not available.

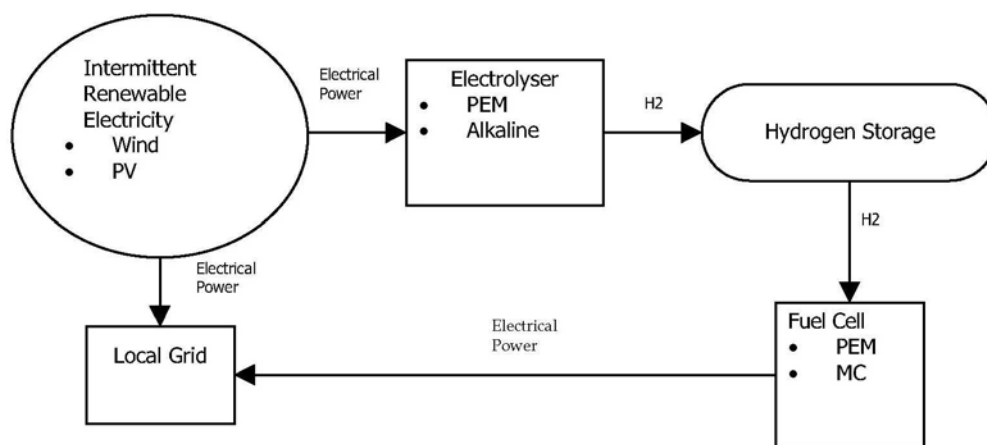

Figure 9-19: Concept of an Integrated Renewables and Hydrogen Storage System

Referring to *Figure 9-19*, the principal components for the integrated hydrogen storage and renewables system include a proton exchange membrane or alkaline electrolyser, gaseous hydrogen storage and a fuel cell (proton exchange membrane or molten carbonate) for converting hydrogen to electricity. The technologies associated with the individual resources (e.g., wind, solar) have been reviewed previously. Other associated issues that to be evaluated to ensure successful operation include:

- ❑ *Electrolyser Coupling with Intermittent Renewable Resources.* When electricity is supplied from random and periodical renewable resources such as wind turbines and/or photovoltaic panels, the electrolyser must respond to power fluctuations ranging from day-night cycle to short time wind speed variations. Therefore the operating conditions would be quite different from a constant power mode.
- ❑ *Power Conditioning.* The power conditioning unit or logic controller has a very important role in operation of hydrogen storage system. First, it is designed to rectify the output voltage of the renewable power source(s) and fuel cell in order to supply regulated electricity to the grid. Second, the renewable sources may generate either DC current from photovoltaic array or fuel cell, or AC current from wind turbine, so the unit is required to convert the renewable source and fuel cell DC current to AC to be delivered to the local grid.

- *Hydrogen Compression.* The requirements for compressing hydrogen are completely dependent on electrolyser technology and storage pressure in pressurised vessel. The PEM electrolyser has demonstrated differential pressure generation of 3,000 psi (207 bar) without any mechanical compression so there is no need for compression of hydrogen from electrolyser to storage if the storage pressure is 200 bar. On the contrary, the highest pressure for commercial alkaline electrolysers is 30 to 35 bar, the need of hydrogen compressor is inevitable if the storage pressure is higher than the electrolyser outlet pressure.

While the above concept may be applied to a remote or island area in Hong Kong, where conventional grid electricity is not available, its feasibility in terms of system efficiency, technical reliability and economic viability will require further assessment on a site-specific case.

9.6.2.3 *Indicative Cost*

Initial capital costs of the energy storage system described above is very high (around US\$ 4,500/kW at 2000 price), and it indicates the capital cost of hydrogen storage system takes the dominant role in the overall system costs. A study predicated that the levelised cost of delivering electricity from the integrated energy storage system and wind energy system to the load was around US\$ 0.57/kWh, assuming 4% discount rate and excluding infrastructure cost.

9.6.3 CONCLUSION

This technology in the hybrid use of new and renewable energy resources is less mature than the NRE technologies themselves. Nevertheless, the hybrid use of solar PV and wind power with fuel cells may be further evaluated for application in a remote area or offshore island community in Hong Kong, if deemed appropriate.

10 CATEGORISATION OF RENEWABLE ENERGY OPTIONS

Chapter 5 to 9 has reviewed a range of new and renewable energy technologies. *Table 10-1* summarises the categorisation of the NRE technologies:

Table 10-1: Proposed Categorisation of NRE Options

NRE	Notes	Category
Solar Photovoltaic (PV)	<ul style="list-style-type: none"> ❑ Grid-connected PV systems are potentially suitable for wide scale adoption in Hong Kong, in both “building integrated” and non-building integrated configurations, provided that the identified constraints (e.g., space) are overcome. ❑ Standalone PV systems may be suitable for site-specific applications. This should be assessed on a case-by-case basis separately. 	<p>Technologies with potential for wide-scale application</p> <p>Technologies for site specific application</p>
Solar Water Heating	<ul style="list-style-type: none"> ❑ Energy savings could be gained by using solar water heating in conjunction with in-line electric or gas water heaters in residential and other applications, if the identified (e.g., space) constraints can be overcome. The total saving on a territorial basis would be small, however, as energy consumed in water heating is only 8% of the SAR’s total power consumption. Recognising that solar water heating could be beneficial for individual application, it is recommended this technology should be further assessed in separate site-specific studies. 	Technologies for site specific application
Wind Energy	<ul style="list-style-type: none"> ❑ <i>Land based rural wind farms in geometric arrays</i> on flat land is not viable in Hong Kong due to significant siting constraints. ❑ <i>Land based rural wind farms in linear arrangements</i> installed on the ridges of mountains and hills could be connected to the grid and produce power for community use, if the identified constraints (e.g., visual, land use planning, etc) can be overcome. ❑ Individual <i>wind turbines</i> may be installed on the roofs of high-rise buildings in urban areas to produce power for community use, if the identified constraints (e.g., technical, environmental, safety, etc) can be overcome. ❑ <i>Near-shore</i> wind farms in array arrangements could be connected to the grid and produce power for community use, if the identified constraints (e.g., siting, environmental, etc) can be overcome. 	<p>Technologies that do not have potential for wide-scale application</p> <p>Technologies with potential for wide-scale application</p> <p>Technologies with potential for wide-scale application</p> <p>Technologies with potential for wide-scale application</p>
	<ul style="list-style-type: none"> ❑ Individual <i>standalone</i> wind turbines may also be suitable for site-specific applications at locations remote from the grid. This should be assessed on a case-by-case basis separately. 	Technologies for site specific application

NRE	Notes	Category
Energy-from-Waste	<ul style="list-style-type: none"> ❑ EfW technologies are compatible with the bulk waste management facilities contemplated under the Waste Reduction Plan, and should be further investigated in separate concurrent or ongoing studies managed by the EPD to avoid duplication of efforts. 	Technologies with potential for wide-scale application
Small-scale Hydroelectric	<ul style="list-style-type: none"> ❑ Run-of-river <i>waterwheels</i> would produce only insignificant power in Hong Kong, but could be suitable for site-specific applications at locations remote from the grid. This should be assessed on a case-by-case basis separately. There does not appear to be sufficient power for wide-scale community use of this technology. ❑ Turbine-generators could be <i>retrofitted</i> at some water treatment plants or other facilities to utilise currently “wasted” hydraulic energy to produce electricity for in-plant use. This should be assessed on a case-by-case basis separately. There does not appear to be sufficient power for wide-scale community use of this technology. 	Technologies for site specific application Technologies for site specific application
Wave Power	<ul style="list-style-type: none"> ❑ Wave energy is considered not suitable for large-scale community use in Hong Kong at present. However, site-specific applications at remote locations may be pursued on a case-by-case basis. 	Technologies for site specific application
Tidal Power	<ul style="list-style-type: none"> ❑ There does not appear to be an opportunity for wide scale application of these technologies in Hong Kong, given the very small resource potential, and significant siting and environmental constraints 	Technologies that do not have potential for wide-scale application
Fuel cells	<ul style="list-style-type: none"> ❑ Building integrated fuel cells (BIFC) may be applicable in Hong Kong, provided that the identified constraints (e.g., space) are overcome. ❑ Application of fuel cells by power utilities as distributed generation systems or as auxiliary equipment at gas-fired power stations are also potentially feasible, provided that the identified constraints (e.g., space) are overcome. 	Technologies with potential for wide-scale application Technologies for site specific application

In summary, it is proposed that the following NRE technologies are potentially suitable for wide scale application in Hong Kong:

- ❑ Solar photovoltaic systems
 - BIPV; and
 - non-BIPV;
- ❑ Wind energy
 - Rural wind farms in linear arrangement;
 - Individual urban wind turbines; and
 - Near-shore wind farms;
- ❑ Energy-from-waste; and
- ❑ Building Integrated Fuel Cells.

PART C

ISSUES & BARRIERS

11 THE OPERATING ENVIRONMENT FOR RENEWABLE ENERGY

11.1 INTRODUCTION

This chapter describes the current baseline in respect of renewable energy sources in Hong Kong, covering the policy, legal and regulatory issues relevant to establishment of a renewable energy market, and the existing status of renewable energy sources in Hong Kong. It provides an over-view of the current situation, and the most important aspects of the institutional and legal context for renewable energy market development.

The promotion of renewable energy technologies, which has implications for both energy supply and environmental objectives, lies at the interface of the policy responsibilities of the Environment, Transport & Works Bureau and the Economic Development and Labour Bureau. The report details some key aspects of energy and environmental policy, and moves on into complementary areas of legislation and regulation relating to development control, building standards and finance.

11.2 CONTEXT

Before delving further into the mechanics of making the supply of renewable energy a reality, it is worth stepping back and giving some thought as to why Hong Kong should be interested in renewable energy sources and technologies.

Internationally, renewable energies have been promoted for reasons that include:

- ❑ Strategic energy policies, in particular a desire to diversify energy sources and reduce dependence on fossil fuels.
- ❑ Environmental policies, on the basis that renewable energy technologies are associated with a reduced, or zero, output of local and global pollutants, especially air pollutants.
- ❑ Industrial policies, with the aim of building competitive advantage in technologies that are seen as providing new market and employment opportunities.
- ❑ A less well-defined desire to provide less resource-intensive, more 'sustainable' energy solutions.

In Hong Kong, the 1999 Policy Address promulgated a number of major policy objectives including:

- ❑ To improve Hong Kong's urban, rural and marine environment, and to optimise the use of resources so as to reduce pollution and waste; and
- ❑ To ensure the provision of sufficient, reliable and reasonably priced supplies of energy for Hong Kong.

As the brief for this study notes, the Secretary for the Environment and Food considered that to encourage the use of new and renewable energy in buildings should be one of the key result areas to reduce pollution arising from energy generation from fossil fuels. At the same time, the then Secretary for Economic Services proposed to study the feasibility and potential for further application and use of alternative forms of power generation and the means to promote and implement those with potential.

There is a particular interest in reducing emissions of air pollutants (e.g. CO₂, SO₂, NO_x). In respect of this policy objective it is important to note that there may be more than one means of meeting a given abatement target. Options include:

- ❑ Reducing the pollution intensity of electricity generation from existing power sources, through fuel switching and/or investment in pollution abatement technologies;
- ❑ Reducing overall energy consumption, by encouraging or mandating the adoption of more energy efficient technologies or behaviour by energy users; and
- ❑ Substitution of conventional power sources by renewable energy technologies.

Policy for renewable energy is thus best considered within the broader context of overall energy and environmental policy. A strategy for meeting a given set of policy objectives at least cost to society may involve all of the above interventions, or only a selection of them. Indeed, energy efficiency measures or fuel switching might provide the same environmental outcome (e.g. less CO₂), and possibly at lower cost than renewable energy. This study will help to inform such analysis in the future, by providing information on the potential, costs and issues associated with substituting conventional energy sources (not only electricity but also heat and fossil fuels) by renewable alternatives.

11.3 ELECTRICITY SUPPLY POLICY & REGULATION

Hong Kong is served by two independent, vertically integrated power companies, each providing generation, transmission, distribution and retailing of electricity in two spatially differentiated areas. Hong Kong Electric Co. Ltd. (HEC) serves Hong Kong Island, Ap Lei Chau and Lamma Island. CLP Power Hong Kong Limited (CLP) serves Kowloon, the New Territories, Lantau and a number of Outlying Islands.

In addition to the power stations, each company owns the transmission and distribution infrastructure within its given geographical area of supply. There is interconnection between the two systems, used for emergency, economic power transfer and reduction in the spinning reserve requirement. Electricity is supplied at 50Hz and 220V single phase or 380V three-phase. A number of industrial/commercial consumers are supplied at 11kV or 33kV¹.

Electricity is generated from coal, industrial diesel oil, natural gas and nuclear power (at the Daya Bay nuclear power plant in Guangdong). CLP also has the right to use 50% of the existing 4 x 300MW capacity of the Phase 1 Guangzhou Pumped Storage Power Station at Conghua (off-peak power from Castle Peak and Daya Bay is stored at Conghua and used to

¹ CDM. 1998. *Feasibility Study of Waste-to-Energy Facilities*. Specifications are set in the Electricity Supply Regulations.

meet peak demand in Hong Kong). In permitting expansion and replacement of generating capacity, the Government has encouraged a move towards cleaner fuels in recent years. This has been facilitated by external developments, such as the availability of natural gas from Hainan gas-fields routed via Shenzhen.

This paper does not attempt to describe in detail all aspects of the regulation and supply of electricity in Hong Kong, but instead highlights issues of particular relevance in the context of this Study. For more information the reader is referred to the Hong Kong SAR Government's website, the websites and public documents of the power companies², and other recent reports³.

11.3.1 Policy Objectives

Government policy objectives in respect of energy supply are explicit, viz:

- ❑ To ensure that the energy needs of the community are met safely, efficiently and at reasonable prices; and
- ❑ To minimise the environmental impact of energy production and promote the efficient use and conservation of energy.

These policy objectives fall under the purview of the Economic Development branch of the Economic Development and Labour Bureau (EDLB) and the Environment Branch of the Environment, Transport and Works Bureau (ETWB). EDLB leads on issues relating to the objective of ensuring that the energy needs of the community are met efficiently, safely and at reasonable prices. ETWB leads on issues relating to the objective of minimising the environmental impact of energy production and promoting the efficient use and conservation of energy. The two bureaux keep each other informed and work closely together on issues that span the two different areas.

The 2001 update on EDLB policy objectives⁴ develops aspects of these objectives in more detail, with the following specific areas identified:

- ❑ Ensure reliable sources of energy supply
- ❑ Administer regulatory requirements for the energy sector
- ❑ Ensure energy needs are met efficiently and safely
- ❑ Promote demand side management in the electricity sector

Energy efficiency, and a concern to limit the environmental impacts of power generation have recently become more prominent in the sector, with a stated intent to promote the use of natural gas as a fuel for power generation and other uses, where feasible and economically viable.

² www.hec.com.hk; www.chinalightandpower.com

³ e.g. *Interconnection and Competition in the Hong Kong Electricity Supply Sector*. ERM.1999.

⁴ *Energy, Postal Services, Meteorological Services and Competition*. Policy Objective and Key Result Areas. EDLB, 2001.

11.3.2 The Schemes of Control

The Government has entered into a Scheme of Control Agreement (SCA) with the Hong Kong Electric Co. Ltd. and Hong Kong Electric Holdings Ltd. (HEC/Holdings), and another with CLP Power Hong Kong Limited (known as China Light & Power Co., Ltd. before 5 March 1999), ExxonMobil Energy Ltd. (known as Exxon Energy Ltd. before 4 July 2000) (CLP/Exxon) and related generating companies CLP/Exxon, Castle Peak Power Company Limited (CAPCO). The latest SCAs date from 1993/1994 and expire in 2008⁵.

The SCAs provide the framework for monitoring the power companies' affairs to protect the interests of consumers. They require the power companies to seek the approval of the Executive Council for certain aspect of their financial plans, including projected tariff levels and the agreement of Government to the annual tariff adjustments. The SCAs set out the terms of a 'rate of return' financial regulatory system that determines the permitted return on net fixed assets related to those activities of the power companies that are monitored. A power company may have other operations that are not subject to the Scheme of Control, for example in other markets outside Hong Kong and in fields other than electricity generation and supply.

For CLP the Permitted Return is the sum of 13.5% of the total value of its average net fixed assets (ANFA) and 1.5% of shareholders' investments made after 30th September 1978 for acquiring fixed assets. The same rules apply to HEC, except the threshold date is 31 December 1978. The key parameters are thus the fixed assets of the power companies that are included in the calculation of ANFA for the purposes of determining the Permitted Return. Deductions are made from the permitted return to give the net return. These deductions include interest on borrowed capital of up to 8% p.a. on the average balance of the Development Fund; interest up to a rate of 8% p.a. on the funds from growth in consumers' deposits after 30 September 1998 for CLP and after 31 December 1998 for HEC; and excess capacity adjustment (if any).

In calculation of the Basic Tariffs, power station operating costs are taken into account. These can include expenditure on power purchase from sources outside Hong Kong - as with CLP's purchase of electricity from Daya Bay. These Mainland facilities are not included in the calculation of net fixed assets.

The SCAs are not franchises and do not provide exclusivity of generation, distribution or supply to the power companies within their geographic areas. In principle a third party power producer would, subject to due process, be free to build generating capacity and distribute power to consumers. In practice, and given the vertically integrated nature of the sector, there are significant barriers to entry into the market, for example the cost of building a viable, alternative distribution system. The two power companies are thus, in effect, monopoly providers of electricity services within their individual regions of operation. This arrangement is reflected in a contract between the two agreeing not to market to each other's customers⁶, while the absence of competition provides the rationale for government intervention to regulate profits and performance.

⁵ The SCA for HEC expires 31 December 2008. The SCA for CLP runs from 1 October 1993 to 30 September 2008.

⁶ *Interconnection and Competition in the Hong Kong Electricity Supply Sector*. Consultancy study undertaken by ERM, paragraph 3.2.15.

The text of the Scheme of Control Agreements sets out the terms of the relationship between the government and the power providers, and the dimensions of the public interest in the cost and continuity of electricity supply:

'The Government recognises that the Companies and their shareholders are entitled to earn a return which is reasonable in relation to the risks involved and the capital invested in and retained in their business, and in return, the Government has to be assured that service to the consuming public continues to be adequate to meet demand, to be efficient and of high quality, and is provided at the lowest cost which is reasonable in the light of financial and other considerations.'

Tariff structures vary between the two electricity companies. In the determination of the tariff rate chargeable to consumers, the power companies will take into account the following adjustments:

- ❑ A rebate through the Rate Reduction Reserve, which is funded by a deduction from the Permitted Return of an annual charge equal to 8% of the average balance of the Development Fund. The Development Fund is a fund that accounts for the difference between the Permitted Return and the actual Scheme of Control Net Revenue. If the actual Scheme of Control Net Revenue for any year exceeds or is less than the Permitted Return, the excess will be transferred to or the deficiency will be deducted from the Development Fund up to the balance of the Development Fund.
- ❑ A rebate or surcharge through the Fuel Clause Recovery Account to pass on the actual costs of fuels consumed to customers.

Current retail tariffs are in the range of HK\$0.8 - HK\$1.1/kWh for most consumers. A recent study found local domestic tariffs to be in the middle range of international prices⁷. The marginal rates paid by consumers increase as consumption rises, although the companies provide special tariff arrangements for particularly large customers.

The terms of each SCA provide for an Interim Review in 1997/1998 and then again in 2003 at which, *'Each of the Companies and the Government will have the right to request modification of any part of the Scheme Of Control.'*

The 2003 Interim Review is of particular interest in the context of this study, since it provides an opportunity for government and/or the utilities to bring issues of mutual interest 'to the table'. This could include (potentially) a package of measures to promote renewable energy technologies, though adoption of the approaches discussed later in this report is not necessarily contingent upon them being addressed through the Interim Review mechanism.

The Scheme of Control Agreements have a pervasive influence on the current market for new and renewable energy technologies. With the expiry of the current agreements in 2008 not far over the horizon, the issue of how the electricity supply market is regulated beyond 2008 will become a steadily more important factor where new investments in renewable energy schemes are being considered. The present uncertainty about the post-2008 regulatory environment provides a backdrop to this study and must be considered in the development of our recommendations. EDLB has committed to map out the broad direction for the post 2008 regulatory regime of the electricity supply market in 2003.

⁷ *ibid.*

It is also relevant to consider the situation in the Mainland China. The Mainland's electricity industry has been going through a period of change for several years. Box 11.1 details how China has proposed to structure her energy market in order to increase the contribution from renewable energy sources.

Box 11-1: Renewable Energy Policy & The Electricity Market in Mainland China

The central Government has made a commitment in the 10th Five Year Plan (2000-2005) to an aggressive program of renewable energy development. Under the 10th and 11th Five Year Plan, the State Development Planning Commission proposes to introduce a Mandated Market Share (MMS) policy for renewable energy that will:

- Include a legal obligation to reach a stipulated target for the contribution of renewables to total electricity demand.
- Introduce an instrument to share the incremental financial cost and benefits among the regions in China, through trading.
- Allow passing the incremental financial cost of renewable electricity to electricity consumers.
- Introduce fiscal and other incentives (e.g. lower VAT) that will reduce the risks of investing in new technology, and the incremental cost burden on electricity consumers.
- Support market infrastructure development, technology improvement and cost reduction.
- Simplify approval procedures for new investment projects in fields such as renewable energy."

11.3.3 Electricity Ordinance

The Electricity Ordinance (Cap 406) provides the Director of the Electrical and Mechanical Services Department with a variety of powers in relation to the standard, security and delivery of electricity supply, and the safety of electrical installations and of electrical products. In respect of connections to the electricity supply, which emerges as an important issue in the consultations, the Ordinance says the following:

(1) Where a fixed electrical installation complies with this Ordinance an electricity supplier shall, within a reasonable time after being requested to do so by the owner of the installation connect the electricity supply to the installation

(2) Subsection (1) does not oblige an electricity supplier-

(a) to supply electricity where it is impracticable or unsafe to do so because of the location of the owner's premises; or

(b) to supply electricity to an owner who does not agree to the supplier's usual contractual terms or to provide reasonable evidence of credit worthiness; or

(c) to supply or continue to supply electricity to an owner of an electrical installation who has failed to perform his contractual obligations to the supplier.

(3) If an electricity supplier refuses to connect the electricity supply to an owner's electrical installation, he shall give the owner the reason for the refusal.

The actual or potential impact of new and renewable energy projects on the quality of supply can be used by existing power utilities as a justification for their unwillingness to connect such schemes. However, extensive overseas experience (e.g. Germany, Netherlands, UK) show that supply quality is unaffected by renewable connections, if technical specifications and utility standards are complied with.

The Ordinance also authorises suppliers to disconnect installations that pose risks to the stability of supply:

(1) *An electricity supplier may without notice disconnect the supply of electricity from all or part of an electrical installation if he considers it necessary to ensure the safe and stable operation of the supplier's or another person's electrical installation.*

(2) *At the request of the owner of the disconnected installation, the supplier shall give the owner the reason for the disconnection within 2 weeks after the date of the request.*

Subsidiary legislation under the Electricity Ordinance, such as the Wiring Regulations and Electricity Supply Regulations, details the specifics of electricity supply protocols and electrical product and installation standards.

11.3.4 Other Energy Suppliers

The third major energy utility in Hong Kong is The Hong Kong & China Gas Company Ltd. (HKCG), 'Towngas'. HKCG produces town gas by cracking naphtha and adding hydrogen. The gas distributed by HKCG is a mix of methane, hydrogen and carbon dioxide, with a calorific value about half that of natural gas. Bottled LPG is also sold in Hong Kong for heating and cooking. There is no regulatory framework comparable to the Scheme of Control Agreement, as such, governing HKCG's activities but an Information and Consultation Agreement is in place. The objective of the Agreement is to increase the transparency of HKCG's operations, tariff-setting mechanism and the justification for tariff increases."

11.4 ENVIRONMENTAL POLICY IN RELATION TO RENEWABLE ENERGY

Environmental policy, including the environmental aspects of energy policy, falls under the purview of the Environment Branch of the Environment, Transport & Works Bureau. The major environmental policy issues of interest when considering the environmental impact of energy production in the current context are:

- ❑ Policy towards greenhouse gas emissions
- ❑ Policy towards local and regional air quality, and the regulation of air pollution

The regulation and controls of renewable energy installations, which may themselves have environmental, planning and landscape impacts is discussed in sections that follow.

Greenhouse Gases

The Hong Kong SAR is not a party to the UN Framework Convention on Climate Change of 1992 in its own right. The Government has indicated that its policy is, 'to contribute to international efforts to stabilise greenhouse gas concentrations in the atmosphere'⁸. The details of the policy on greenhouse gas emissions are under development.

⁸ Economic Services Bureau (1998). *Energy Policy from an Environmental Perspective*. ACE Paper 48/98.

A recent study for the Government⁹ determined that carbon dioxide (CO₂) constituted over 83% of the total emissions of the six greenhouse gases in 1997 (including carbon dioxide, methane, nitrous oxide, hydrofluorocarbons, perfluorocarbons and sulphur hexafluoride). 97% of the total CO₂ emissions were estimated to have come from the energy sector, within which about 64% came from power generation.

GHG emissions from the electricity sector are influenced by factors that include:

- ❑ Consumer demand for electricity
- ❑ Fuel sources : the mix of coal, oil, gas and nuclear - and potentially renewables

The last 10 years have seen:

- ❑ The inclusion of nuclear power in CLP's power sources, brought in from Daya Bay
- ❑ A switch, for new generating sets, from coal and oil towards natural gas
- ❑ The introduction of Demand Side Management programmes to promote reduction in demand through investment in energy saving and energy efficient technologies.

Renewable energy technologies have the potential to contribute to the GHG control agenda in Hong Kong as part of a multi-strand strategy for the substitution and reduction of conventional fossil fuels.

Regional and Local Air Quality

The state of air quality in Hong Kong has attracted extensive interest and concern in recent years. Key pollutants include sulphur dioxide, particulates and nitrogen oxides. A wide range of measures has been introduced to address this problem.

Electricity generation is one of the major sources of Hong Kong's air pollutant emissions. Data published in the former Planning, Lands and Environment Bureau's *Clean the Air* report suggest that in 1997 power stations contributed 33% of Hong Kong's particulate emissions, 65% of the sulphur dioxide and 45% of nitrogen dioxide.

There is consensus that air quality is having an impact on morbidity and mortality in the community, with impacts on well-being, productivity, health care services, etc. Other impacts may include ecological damage and increased building cleaning costs.

Pollution output per kWh can be reduced by changing the fuel mix of the two utilities away from coal and oil towards cleaner fuels (such as natural gas and renewables), by cleaner, more efficient generating technologies, and by pollution abatement (e.g. flue gas desulphurisation). Such measures are offset by increasing demand for electricity (i.e. higher overall output). The established policy of promoting natural gas as a fuel for power generation where viable supports moves in this direction.

⁹ *Greenhouse Gas Emission Control Study*. ERM for Environmental Protection Department, 2000.

To the extent that renewable energy sources displace the combustion of fossil fuels, emissions of local air pollutants will be reduced directly as a result of any move towards renewables.

11.5 RE PROJECT DEVELOPMENT

As with any other form of development, new and renewable energy (RE) projects are subject to due process under the established legislation and regulations, which cover such issues as development control and building standards. Internationally, the amenability of this regulatory environment to the often unfamiliar issues raised by renewable energy projects has proven to a significant barrier to RE investment.

This section discusses some of the key components of this legislative and regulatory environment in Hong Kong. The strategy that follows presents a set of recommendations for raising awareness and generating guidance about renewable energy projects and the issues they raise among key parts of the administration. These activities, set in the context of the renewable energy programme as agreed at that time, should assist in minimising the administrative barriers to the implementation of RE projects and may highlight areas where specific, focused attention to administrative process is required to deal with specific issues.

11.5.1 Planning and Lands Related Issues

11.5.1.1 *Private land*

The development of land based renewable energy installations will be subject to planning and lease controls. In planning terms, a renewable energy installation may be interpreted as a “public utility installation” or a “utility installation for private project” (see *Table 11-1* below)¹⁰. A project is considered as a “public utility installation” if it serves more than one private development e.g. a wind farm serving the local community on an outlying island. A series of photovoltaic panels set up to supply electricity to one private residential estate would be considered as a “utility installation for private project”. If “public utility installation”/“utility installation for private projects” uses are permitted in the zoning of the development site (e.g. “open storage” zoning and “commercial” zoning), the owner of the land can set up renewable energy installation provided that the lease conditions of the land will not be violated. However, the development needs to comply with Chapter 7 of the Planning Standards and Guidelines on utility services.

¹⁰ Town Planning Board. Definition of terms used in statutory plans.
http://www.info.gov.hk/tpb/index_e.htm

Table 11-1: Definition of Terms in Statutory Plans

Term	Definition	Remarks
Public Utility Installation	Means any tank, structure, building or part of a building built on, over, or under ground level for the provision of water, gas, electric, broadcasting, television and telecommunication services to serve the local district.	It includes pumphouse, electric substation & telephone exchange, but excludes such major installations as sewage treatment plant, electric power station, gas works, radar, telecommunication electronic microwave repeater, television and/or radio transmitter installation to serve wider geographical area. It also excludes building wholly or principally used as an administrative or business premises of an utility company.
Utility Installation for Private Project	Means any tank, structure, building or part of a building built on, over, or under ground level for the provision of water, gas, electric, broadcasting, television and telecommunication services to serve particular private development.	

In certain types of zonings, such as “residential” and “agriculture”, a “public utility installation” may be a permitted with or without conditions, subject to the project proponent applying to the Town Planning Board (TPB) for planning permission. The planning application to the TPB is submitted through the Planning Department (PlanD). PlanD will circulate the application document to a number of relevant departments for comments. Planning Department will consider land use compatibility, visual and landscape impacts. Other departments such as Civil Engineering Department and Environmental Protection Department will consider the technical feasibility and environmental impacts of the proposed development. The relevant District Office, representing the local community, will also be consulted.

Considerations for wind farm development may include local community objections to visual impacts and impacts on feng shui. The latter is a recognised issue for project development in the New Territories. Departmental comments and public views will be submitted with the planning application to the Town Planning Board for consideration. The Town Planning Board may reject or grant planning permission with or without conditions. The installation can be developed only when the required planning permission is secured, and providing that the lease conditions of the land are not violated. The developer also has to satisfy all the conditions imposed by the Town Planning Board, if any, and to follow the planning guidelines on utility services.

11.5.1.2 Government land

The above assumes that the land is privately owned (usually by the project proponent). If the development site concerned is on government-owned land, the situation is more complicated. In all cases the project proponent has to approach the relevant District Lands Office (DLO), which may grant the required development right. If the development site is on land zoned “country park”, the project proponent must apply to the Agriculture,

Fisheries and Conservation Department for development permission under the Country Park Ordinance before approaching the DLO. If the land is not covered by any statutory plans, the project proponent can liaise with the relevant DLO directly.

The DLO may grant the land to the project proponent as a short term tenancy (STT), for which an annual rent is payable, or a private treaty grant (PTG). The period of an STT can be as long as 7 years, beyond which the STT may be renewed on a quarterly basis. In contrast, the length of a PTG is around 50 years and normally a premium would have to be paid based on the industrial value of the project. If policy support is secured from the Government, the project proponent may be able to negotiate a nominal rent or for the premium to be waived.

The District Lands Office will consult the headquarters of the Lands Department on any territory-wide concern. The period required for the process is uncertain – successive rounds of comments and response can delay a decision.

The Lands Department controls all unauthorized structures. PV panels on roofs of village houses are reportedly tolerated. Consultations suggest that provision of attractive, standard designs for integrating PV into houses (for example) would be regarded as a step forward.

11.5.1.3 Offshore developments

Placement of wind turbines in nearshore or offshore locations clearly involves development and ‘occupancy’ of the seabed, both for the turbines themselves and for the cables connecting the turbines to the main electricity grid. Within the HKSAR boundary, the seabed is owned by the government, which may grant rights for development. The Lands Department may consider the project as reclamation, and prepare a gazette notice for the proposed development under the Seabed and Foreshore Ordinance. Authorisation of a development right under the Seabed and Foreshore Ordinance will be granted only when all issues have been resolved. Public views, and especially objections from fishermen, will be solicited in the gazettal process. There are precedents for fishermen to receive compensation for the impact of reclamation projects on fisheries. It is understood that there are also precedents for power companies to pay a premium to the government for use of the seabed for submarine cables.

11.5.2 Environmental Impacts

Though promoted for their environmental benefits, renewable energy installations may themselves have environmental impacts in construction and operation.

It is likely that any large renewable energy installation (such as a wind farm or waste to energy facility) will require an environmental permit for construction and operation under the Environmental Impact Assessment Ordinance (EIAO). This would certainly be the case if the project is defined as a public utility electricity plant, or is proposed to be located in a country park or conservation area, or involves reclamation (all “designated projects” under the Ordinance).

In order to obtain an environmental permit for a designated project, the project proponent must go through the statutory environmental impact assessment process. Firstly, the project proponent is required to apply for an EIA study brief by submitting a project profile. There

is the opportunity for the public and the Advisory Council on the Environment (ACE) to comment on the project profile on environmental issues before the Director of the Environmental Protection Department (EPD) issues the EIA study brief.

The project proponent may then proceed with the EIA study following the procedures and guidelines outlined in the Technical Memorandum on the EIA process, and then seek approval of the EIA report under the Ordinance. The public and the ACE may comment on the EIA report before it is approved.

The Director will take comments from the ACE and the public into account before issuing the EIA study brief or approving the EIA report. Other authorities (government departments and bureaux) are also consulted prior to issue of the EIA study brief and approval of the EIA report.

The project proponent must apply for an environmental permit, which can be obtained on approval of the EIA report. Obtaining an environmental permit should not be an issue if the report meets the Technical Memorandum's and EIA study brief's requirements. However strong public objections on environmental grounds may slow the process if the EIA report has to be modified to take these into account. If the applicant is aggrieved by a decision of the Director, he may lodge a notice of appeal within 30 days of receipt of the notice of the decision.

11.5.3 Building and Construction Issues

The Buildings Department (BD) controls all private development in Hong Kong under the Buildings Ordinance and allied legislation. Any person who intends to carry out building works is required by law to appoint an authorized person, and where necessary a registered structural engineer, to prepare and submit plans for the approval of the Building Authority under the Buildings Ordinance. They are also required to appoint a registered contractor to carry out the building works.

Authorized persons, registered structural engineers and registered contractors have statutory responsibilities for supervising and carrying out building works and submitting stability certificates and test reports. When breach of statutory provisions is identified, the Building Authority may order works to cease or to be remedied. Offenders are also liable to prosecution or disciplinary proceedings.

The Building Department will check plans for compliance with the law, and refer them to other relevant Government departments for examination in their areas of concern. This centralised proceeding system ensures that all statutory technical standards, safety standards and other requirements under the law are met.

Any building-integrated new or renewable energy installations (PV for example) would have to comply with the codes of practice and standards in order for approval of the building plans to be obtained. The specific standards concerning PV include those on wind effects, cladding and curtain wall systems requirements. The Building Innovation Unit assists innovative and unusual development proposals (such as large solar panels on the roof) to obtain approval. Short circuits in PV panels are not easily detected, and fire retardant cables are required. The Fire Safety Ordinance applies.

Before work starts, consent to commence building works is required from the Building Authority, and the Building Department will monitor sites where work is in progress and inspect sites regularly, particularly at critical stages for safety assurance and for compliance with statutory requirements under law. The Building Department also makes final checks before issuing an occupation permit.

11.5.3.1 Green buildings initiative

Amongst a series of new initiatives and measures, the Building Department has initiated a comprehensive review of the Buildings Ordinance and Regulations with a view to modernising the legislation and facilitating the construction of environmentally friendly and innovative buildings.

The Department has also released a practice note on green features for new building developments, which was jointly prepared with the Lands Department and the Planning Department. This note sets out incentives provided by the government to encourage the design and construction of green and innovative buildings. The package of incentives includes a list of 'green' features that may be exempted from the Gross Floor Area (GFA) and Site Coverage (SC) calculations. The joint practice note states that the list would be continuously reviewed and revised in line with ongoing development of green buildings and new incentives.

11.6 FINANCIAL ISSUES

This section covers financial incentives and sources of project funding potentially available for renewable energy projects in Hong Kong.

11.6.1 The General Investment Environment

Hong Kong's economic policy with regard to industry and services may be described as *laissez-faire*. Subsidies, grants, price controls, quotas and interventionist mechanisms are scarce.

Energy consumption is not taxed in Hong Kong. There are no 'eco-taxes' (e.g. carbon tax or SO_x/NO_x tax) to internalise local or global pollution costs associated with electricity generation from fossil fuels. At present renewable energy projects would therefore need to compete on the basis of straight financial criteria alone.

The business environment is not, however, devoid of investment incentives. Hong Kong accounting rules include generous terms for depreciation of certain types of capital expenditure. The initial allowance is 60% in the year in which the expenditure is incurred. The annual allowance ranges from 10% to 30% for different types of plant and machinery. The total depreciation allowance for the first year can thus be as high as 72% (i.e. 60% plus 30% of the remaining 40%)¹¹. A 100% immediate write-off for new expenditure on plant and machinery specifically related to manufacturing, and for new expenditure on computer hardware, software and systems development was introduced in 1998.

¹¹ <http://www.info.gov.hk/fb/bdgt98/english/booklet/booklet.htm>

Indirect incentives mechanisms have also been deployed. A relevant example is property development where, as noted above, the environmental attributes of buildings can now be taken into account in calculation of gross floor area.

11.6.2 Project Finance

In its current demonstration phase of RE project development, local projects have sourced a variety of public and private funding sources. The importance of private sector investment would be expected to increase if positive conditions are created for renewable energy project development.

11.6.2.1 Research, Development and Demonstration Funding

A wide variety of funding sources has been used to finance the renewable energy 'demonstration projects' that already exist (or are currently planned) in Hong Kong. The main sources of finance for these projects have been:

- ❑ Government - through Departments (principally the Architectural Services Department), through the university sector and through public funding programmes such as the Innovation and Technology Fund.
- ❑ The Corporate Sector - the two power companies have both co-financed demonstration projects involving renewable energy technologies, and have contributed to their development in terms of personnel (staff time). Other corporate sponsors have included major transport firms.
- ❑ Independent Funds - the main example here is the Jockey Club, which has supported Friends of the Earth's 'Earth Station' project.

11.6.2.2 Private Finance

Hong Kong is a regional centre in East Asia and China for project finance. Hong Kong also has a long domestic tradition of private sector provision of infrastructure and services. There is, however, very limited experience in the region of development of major renewable energy schemes (except for large scale hydropower projects), and 'boutique' RE financiers of the kind found in Europe and North America are not thought to be established in Hong Kong at this point.

At present, the principal barrier to private investment in RE technologies is the basic financial viability of projects, particularly in an operating environment where the power generated cannot be sold directly into the local market. For smaller scale schemes, such as BIPV and LFG projects there is little reason to expect that availability of finance would be a problem once sufficiently attractive rates of return emerge.

11.7 THE STATE OF RENEWABLE ENERGY DEVELOPMENT IN HONG KONG

11.7.1 Introduction

By international standards, Hong Kong's renewable energy sector is still at a very early stage of development. There have been a number of small-scale solar power demonstration projects, and a few (very) small wind turbines are in operation. One fuel cell demonstration project is under development. The application that is most advanced at the present time is the utilisation of landfill gas, but even this is limited in extent for reasons discussed further on. There is at present no waste incineration with energy recovery, although the options for such use of such technologies, and the environmental issues that they themselves raise, are currently under detailed consideration.

Energy-from-waste schemes aside, existing projects are generally relatively small scale initiatives implemented by local corporations, the universities, government funds or departments, or non-governmental organisations. Tables 10.2 – 10.4 list the projects identified during stakeholder consultations and the literature review for this study. The Tables show that new and renewable energy technologies make a negligible contribution to overall electricity supply at present. However, Stage 1 of this study has shown that the potential technically achievable renewable resource is significant. Understanding what is required to close this gap and putting in place measures to do so is the prime challenge for the RE strategy.

11.7.2 Energy from Waste

Though not strictly a 'renewable' energy source, energy recovery from waste is of significant interest in the context of this study. This section reviews experience and consultations in relation to landfill gas, municipal solid waste incineration and sewage sludge treatment, although only the former two are considered in detail.

11.7.2.1 Landfill Gas

Landfills in Hong Kong can loosely be divided into two groups: the current generation of strategic landfills now in use (SENT, NENT, WENT), and old landfills used in the period 1973-1996 and at various stages of rehabilitation (there are 13 of these). Restoration contracts have been let for twelve old landfills, though many of them have peaked in their generation of landfill gas.

The three current strategic landfills are operated by the private sector under design-build-operate contracts with Government. These contracts last until the end of the landfill life. They include a requirement for restoration work once the landfill is full, and the installation of a landfill gas (LFG) recovery system. The contracts allow the Contractor to make use of materials recovered from the site, whether from the land or from the permitted waste (subject to the payment of a royalty to government on the associated profits). These provisions apply to landfill gas utilisation. There is also a provision for the government to take over part of the site and instruct the contractor (in return for payment) on the use of such materials, in the event that the contractor does not use or propose to use the materials.

The development of landfill gas resources is more advanced than any other alternative energy source in Hong Kong. Three projects are described below.

Table 11-2: Energy from waste projects installed or under development

Description	Implemented by
Landfill Gas (LFG)	
Generation of electricity from LFG for on-site use: WENT - 2.7MW SENT - 1.94 MW NENT - 1.9MW Jordan Valley - 218kW Tseung Kwan O Stage I - 155kW	Landfill operators
Use of LFG for heating in leachate treatment process on site: WENT, SENT, NENT, Gin Drinkers Bay and Tseung Kwan O Stage II/III landfills	Landfill operators
Shuen Wan Landfill: approx. 1200m ³ /hr of LFG is conveyed to a gas production plant owned by Towngas. The LFG is used as an alternative fuel to substitute for naphtha in process heating applications as part of the town gas production process.	Hong Kong & China Gas Company (HKCG)
Potential use of landfill gas as fuel for the waste trucks on their route between the refuse transfer stations and the landfill	Swire SITA/HKCG
Waste to Energy Incinerator Facility The power generation capacity for WEF is 75MW gross or 52.5MW net export for each 3,000 tpd facility.	EPD

Note: In an arrangement unique in Hong Kong, power generated at SENT is exported to CLP.

Shuen Wan Landfill : The Shuen Wan landfill was closed in 1995. In addition to the passive vent trench installed around the perimeter of the site, eighty-seven gas extraction wells were installed to control off-site migration of gas. The collected gas was flared until September 1999 when a new scheme to treat and compress the gas was brought into operation. After evaluation of various options, approximately 1100 cu.m./hr of gas is now fed through an underground pipeline to a Towngas production plant where it is used to provide process heating under a 10 year contract between HKCG and the Hong Kong Landfill Restoration Group. From September 1999 to the end of year 2000, about 14 million cu.m. of LFG were exported.

Jordan Valley Landfill : The Jordan Valley landfill is one of five landfills recently restored under the Urban Landfill Restoration Contract. Twenty LFG/leachate extraction wells and a flare stack were installed, together with a leachate pre-treatment works. A LFG-to-electricity utilisation scheme was implemented, the power being used to meet the electricity demand of the leachate treatment process. Gas volumes were too low for use off-site to be seen as viable.

NENT : 500m³/hour of the LFG generated at NENT is utilised in a 1.9MW on-site power plant. It is converted to electricity, which is used to power the leachate treatment plant and meet other on-site power needs. The operator has expressed a willingness to invest in

power generation facilities to make use of the remainder of the gas, but there is at present no market with the power utilities for the electricity so generated. In consultation, this was attributed to the incentive structure created by the Scheme of Control Agreements. Other options are currently being explored.

Some sources have suggested that the nature of landfilled waste in Hong Kong (heterogeneity, organic content) has had a negative impact on the reliability and predictability of LFG arisings. However, based on discussions with landfill operators, it is not yet clear whether the problem is any greater in Hong Kong than elsewhere, or whether the issue is simply one of having a profile of gas generation over time that is different to expectations based on experience in North America or Europe.

11.7.2.2 Thermal Treatment of Municipal Waste

Thermal treatment of municipal waste offers significant reductions in waste bulk, which is an attractive proposition given Hong Kong's scarce, and rapidly diminishing, landfill capacity. There are, however, environmental issues associated with particular thermal waste treatment technologies such as incineration that will need to be worked through with the community before broad-based support for this technology can be expected. These issues include air emissions, for example.

At the present time there are no active municipal waste treatment facilities, but proposals for integrated bulk waste treatment facilities are currently under consideration by the administration. These proposals are subject to detailed analysis in separate studies for the Environmental Protection Department.

Earlier studies on Waste-to-Energy Facilities (WEF) in Hong Kong examined the feasibility of providing 6,000 tonne per day capacity on either one or two sites. Facilities were judged equivalent to two units each with 75MW generation capacity, or one of 150MW capacity. Taking into account internal power consumption (at 30%) the export capacities were adjusted to 52.5MW and 105MW respectively.

In larger jurisdictions, where individual waste facilities operate in a market environment, obtaining a reasonable price for WEF generated power is an important component of the overall financial viability of the project. In Hong Kong, where waste management facilities are government projects (though privately operated), the terms on which power can be sold impacts on the net cost to the government of the project, since private contractors can be expected to factor energy related revenues into their bid prices. In the course of these earlier assessments discussions were held with the power companies and the purchase of power from the incinerators was recognised as a significant issue.

A further option considered was investment in a WEF by one (or both) of the power companies. There are quantifiable operational advantages from a WEF being integrated into power company's operations. Furthermore, if the WEIF were accommodated within the terms of the SCA, the problems associated with the purchase of 'external' power by the utility would be removed. Such an option, however, may not be preferred from the point of introducing new players in the electricity market.

11.7.2.3 Other Wastes

Enhancement of sewage treatment processes will increase the volume of sewage sludge requiring disposal. A number of options are under consideration for managing this sludge, including incineration (it is possible that an incinerator would be operational by 2010). Data obtained by the consultants suggest that such a facility would be in a position to export approximately 12,000MWh of surplus power each year. The institutional and financial issues discussed above for MSW apply equally to sewage sludge incineration.

11.7.2.4 Summary

Hong Kong's landfill sites produce large quantities of landfill gas. With the active encouragement of EPD, the landfill operators, working with Towngas and others, have made considerable efforts to find uses for this energy source. So far results have been mixed. Despite some successes, most gas is still flared off. At present 40% of the available LFG is being utilised for power generation, leachate treatment and town gas production.

The three strategic landfills, Tseung Kwan O landfill, Shuen Wan landfill and PPVL, are estimated by EPD to produce a maximum 38,430m³/hr of LFG consisting of 50-60% methane in 2000 (23,300m³/hr from the three strategic sites alone). At 35% conversion efficiency this is equivalent to 687 GWh of electricity – about 1.9% of Hong Kong's annual demand.

The options for more rational use of this resource are constrained by the lack of a market for LFG electricity. Where LFG is being converted to electricity it is only for on-site applications, such as powering leachate treatment systems. Other applications, such as LFG injection to the domestic gas supply and use as transport fuel, are technically possible but generally not attractive in commercial terms because of the higher capital costs involved. The relative remoteness of some landfills is also an issue, and the general absence of a market for electricity generated from LFG is attributed to the power company's response to the SCA incentive structure rather than major technical barriers.

There are no thermal MSW treatment facilities in Hong Kong at present, but those that are planned offer significant potential for energy supply providing issues of public acceptance (of the facility) and export for sale (of the generated electricity) can be addressed. In energy terms these are the largest of the alternative energy source projects in prospect for Hong Kong.

11.7.3 Wind Energy

Hong Kong has had little experience with wind turbines, other than very small-scale demonstration projects.

Table 11-3: Wind projects installed or under development

Description	Implemented by
Hybrid Photovoltaic / Wind Turbine system at the Ming Fai Camp on Cheung Chau. The 2kW wind turbine will be installed on the roof and supply electricity to some of the guest rooms.	Caritas

<p>Green School Project Demo. PV on the roof and vertical façade. Small wind turbine on the roof. The project includes a Building Energy Management System. Although still at the design stage, the power generation is not likely to be more than 2-3kW.</p>	<p>Funding from the CLP Research Institute and the Innovation and Technology Fund</p> <p>ArchSD are building the school for the Education Department</p>
---	--

A particular issue that emerged during consultations was the space required for wind farm developments. With 600 kW turbines standing perhaps 60 metres tall and needing to be spaced several hundred metres apart, finding appropriate sites was regarded as a major problem if anything more than individual turbines was to be considered.

Some consultees advocated placing onshore turbines in selected areas of the Country Parks (windspeeds are highest on high ground, making the ridge lines the preferred location from a technical perspective). However, others regarded the prospective visual impact of the turbines in such locations as unacceptable. The fact that Country Parks are protected from all but the most essential infrastructure development must also be noted. The onshore space constraints inevitably lead to a consideration of nearshore and offshore locations. Turbine spacing and blade height is such that the passage of small vessels should not be impeded around the turbines – reducing the potential impact on fishing activities.

The planning and land issues relating to wind farm development are referred to above. It is fair to expect that the lack of local experience in relation to wind turbine installations will result in initial applications taking some time to process, although these are potentially major international projects where a ‘local’ supply side is not normally needed.

11.7.4 Photovoltaics (PV)

Most of Hong Kong’s experience in the use of PV panels has been in relation to building integrated photovoltaic (BIPV) systems. The majority of these have been one-off projects sponsored by the government, tertiary education institutions or major corporations. Recent examples include:

- ❑ A partnership between Hong Kong University and Hong Kong Electric on the installation of a demonstration BIPV scheme on the HKU campus (48 m², 5-6 kW PV curtain glass panel, grid connected).
- ❑ A Green School demonstration project, supported by CLP Research Institute and the Innovation & Technology Fund, with technical assistance from ASD, and incorporating PV panels on the roof and vertical façade.

Table 11-4 details some of the projects installed or under development.

Table 11-4: Solar PV projects installed or under development

Description	Implemented by
<i>Building-integrated</i>	
1.2kW vertical photovoltaic panel array on university building. Connected to grid.	Hong Kong University in association with the Hong Kong Electric Co Ltd (HEC)
13kW solar panels on Science Park building.	Science Park Corporation/Architectural Services Department (ArchSD)

<p>PV system at two toilets in for the AFCD offices in Quarry Bay supplies around 1kW for the electrical loading within the toilets. Agriculture, Fisheries and Conservation Department (AFCD).</p>	
<p>Hybrid Photovoltaic / Wind Turbine system at the Ming Fai Camp on Cheung Chau. The 3kW PV modules will be integrated into the skylight and supply electricity to some of the guest rooms. Due to be completed in October 2001</p>	Caritas
<p>A 5 kW PV roofing consisting of 100PV modules attached with insulation foam will be installed on the reception building of the Kadoorie Farm and Botanic Garden. It will be grid connected. In addition to PV electricity generation, the thermal insulation on the roof will reduce air-conditioning loading. Due to be completed in November 2001.</p>	Kadoorie Farm/Hong Kong Polytechnic University
<p>No 1 Peking Road: new development which will include a 700sq.m. PV panel supplying around 45kW to the building (less than 5% of the total energy requirements). This will not be grid connected. The PV installation will cost the developer around HK\$9million.</p>	Private Developer
<p>Green School Project Demo. PV on the roof and vertical façade. Small wind turbine on the roof. The project includes a Building Energy Management System. Although still at the design stage, the power generation is not likely to be more than 2-3kW.</p>	<p>Funding from the CLP Research Institute and the Innovation and Technology Fund ArchSD are building the school for the Education Department.</p>
<p><i>Other</i></p>	
<p>Photovoltaic System on bus shelter in front of the Tsimshatsui Mosque. The PV system will supply electricity to the LED signage board and advertising panel</p>	Kowloon Motor Bus

11.7.4.1 Building-Integrated PV

As shown in *Table 11-4*, most of the PV installations in Hong Kong have been BIPV projects. For this study consultations have been conducted with technology providers, architects, property companies, government departments and academic specialists to investigate the legal, institutional and practical issues involved in PV application in Hong Kong. Consultees in the PV sector identified two main barriers to the greater uptake of BIPV systems:

- ❑ Connection - the lack of transparency with regard to connection standards and costs, and the conditions under which connection can be refused.
- ❑ Comparatively long pay-back periods on PV investments.

The PV installations under consideration have, in most cases, been capable of supplying no more than 5% of a commercial building's energy demand. However, the power companies'

caution in permitting (or rather not permitting) the grid connection of such schemes has meant that designers have had to isolate the PV circuit from the building's main power systems. This increases the complexity and cost of the project (e.g. by requiring investment in energy storage/batteries), and so decreases the viability of the proposed investment.

For buildings with negligible potential export from BIPV, the utility supply to the building is normally sized to cater for the maximum demand of the building, without any allowance for BIPV capacity. This seems to be the situation that is likely for most installations in Hong Kong and therefore should not pose a design problem if adopted for installations where PV output is small compared with the building demand. The utility system should normally be able to provide full back-up capacity. Feeding back into the grid is seen as a mainly economic design issue – international experience suggests no major technical barriers.

Anecdotal evidence collected in the course of the study suggests that the BIPV schemes adopted so far have tended to have a pay-back periods far longer than those usually considered acceptable by the private sector – a differential which, if it persists, is clearly a major barrier to the wider uptake of BIPV by the private sector. Consultations also point to the continued availability of energy saving investment opportunities that can deliver similar environmental outcomes to BIPV (i.e. reduced air pollution through avoidance of combustion of fossil fuels) at considerably lower cost.

For building developers evaluating energy efficiency and BIPV as alternative options for new developments, consultations suggest that energy efficiency investments tend to present fewer implementation problems. The grid connection issues do not apply to energy efficiency projects, which can reduce (net) building energy demand by a similar amount.

The Housing Authority has investigated PV systems for housing developments, but is putting greater effort into energy efficiency where the gains are seen as cheaper and larger. A key issue highlighted for the financial viability of BIPV building components was cost-equivalence to other more conventional components.

In order to address these cost barriers within the current regulatory framework, local PV contractors are looking at ways to promote PV systems as alternative curtain wall materials. Indicative figures quoted to the consultants were aluminium cladding at HK\$2000/m², stone cladding at HK\$9000/m² and PV panels in the middle at around HK\$6000/m². Contractors expect the cost of PV installations to fall in the future, while their performance (in energy conversion terms) is also expected to improve.

The developer's requirements for performance and lifetime of the curtain wall, and the requirements of the Buildings Department (which oversees application of the Buildings Ordinance) are important. Contractors consulted have followed local practice for curtain wall glass. Safety may also dictate that standard PV panels are modified. For example, the contractor for a new high-rise office development incorporating a 700sqm, 45 kW PV panel reported that, under the BD code of practice on wind loading, the glass had to be 4mm thick (rather than the usual 3mm) and should be tempered, increasing costs by 10-20%. Costs had also been increased because the panels had to be custom made, and the fact that there is no possibility of grid connection further increases the complexity and cost of the linkages to internal building systems. In this instance, the PV power will be used for curtain wall ventilation – cooling the building and reducing air-conditioning requirements.

In discussing factors influencing decisions on BIPV investments, another property company mentioned disturbance factors to tenants (e.g. if materials have a shorter life than current materials), maintenance and repair. No information was available about how BIPV performance held up over prolonged periods, the demonstration projects identified all being relatively recent. One consultee suggested that the ambient humidity and pollution may contribute to the accelerated corrosion of connections, with potential impacts on equipment lifetime and maintenance requirements. Cabling is reportedly governed by CLP and HEC safety rules, but since there has been little independent power generation in the past the utilities' only have 'standard' rules in this respect.

11.7.4.2 Other PV Applications

Hong Kong has many thousands of cuttings and slopes that require on-going maintenance and investment. The Civil Engineering Department has been looking at options for innovative use of these areas and in this regard is making an application for funding for a study on the potential application of PV panels on slopes. The concept is of these installations providing power for public facilities (such as schools or street lighting), but it is not expected that such schemes would be financially viable at current PV cost levels.

There are other examples of more large-scale PV installations that might potentially be of interest in Hong Kong. These PV Power Stations (PVPS) might, for example, be located on large industrial buildings (e.g. storage sheds in the port area) or along covered transport corridors (MTRC has expressed some interest in this possibility). The main characteristic of such an installation is that it would feed directly into the grid rather than meeting part (or even all) of the load of the building or site where it was located. Such installations are not expected to be large in number, and face the same barriers as other PV systems identified above.

11.7.5 Fuel Cells

Consultations suggested that at the present time there are no commercial scale fuel cells operational in Hong Kong, either in the university sector or in private commercial properties. This is expected to change with the completion of a demonstration project at the Science Park site, where a 250kW scheme is under development.

There are some international examples of fuel cells being used as back-up power supplies for office buildings, substituting for standby generators. Limited initial consultations with office developers suggest the fuel cell solution to such requirements has not yet been adopted locally, and there is a comparative lack of familiarity with the technology.

12 KEY ISSUES AND OPTIONS

12.1 INTRODUCTION

The consultations and analysis undertaken in Hong Kong echo international experience that there are many non-technical issues that act as barriers to realisation of renewable energy potential. This experience shows that there is a set of what might be termed 'generic' market barriers that affect the development of the renewable sector as a whole, as opposed to individual. Collectively these can reduce the financial viability of RE projects and discourage investment. They include:

- ❑ The regulations and incentives under which power providers operate - which tend to drive investment towards conventional generation as the least cost option
- ❑ The pricing of conventional power – especially whether pollution costs are internalised in through taxes or standards, and thus whether there is a 'level playing field' for renewables
- ❑ The ability of third party renewable energy power generation projects to get connected to the electricity grid
- ❑ The standards and charges applied to such third parties, simply with respect to that connection to the grid
- ❑ The power purchase prices available to renewable energy projects, and the security of such power purchase agreements
- ❑ Awareness and understanding of RE technologies in the commercial sector
- ❑ Awareness and understanding of the benefits of renewable energy in the community.

In addition, there are barriers that are more specific to individual technologies, examples being community concern at the visual and noise impacts of onshore wind farms, architects' unfamiliarity with the properties and performance of PV panels and the complex approval procedures for energy-from-waste projects.

Many of these issues apply in Hong Kong. The present chapter discusses in general terms how the barriers that have been identified might be overcome, based on the following hierarchy of measures:

- ❑ The policy framework for renewables
- ❑ Generic 'enabling' measures to provide market access to renewable energy technologies
- ❑ Technology-specific measures

This discussion forms the basis of the proposed strategy and action plan elaborated in the chapters that follow.

12.2 SETTING A POLICY AND LEGISLATIVE FRAMEWORK

Governments have an important role in building support for renewable energy as a concept and creating the conditions in which a viable market for RE projects can emerge. The variety of barriers to RE market development and the important linkages with the regulation of electricity markets mean that policy support is vital, even for RE technologies that are relatively well-developed and cost effective.

The exploitation of renewable energy sources is best considered as part of the energy and environmental policy portfolio. RE is a new policy issue in Hong Kong, but the technologies clearly have the potential to contribute to a set of existing policy objectives. In particular, RE can contribute to those policies relating to regional air quality, greenhouse gas emissions and the environmental impact of energy supplies.

The development and adoption of a renewable energy strategy and action plan, together with commitment to a set of targets for renewables' contribution to energy demand, will signal the government's support for these technologies. The strategy should state clearly the rationale for providing support for the development of the renewable energy market in Hong Kong.

Any support for new and renewable energy technologies is necessarily provided within the existing policy and legislative framework. In developing the strategy, one key issue is the extent to which options that address the key barriers to renewable energy deployment require additions or changes to other policies, legislation and contracts. For Hong Kong, the formal instruments of primary concern are the Scheme of Control Agreements and the Electricity Ordinance.

The 2003 Interim Review of the Scheme of Control Agreements (SCAs), and the subsequent expiry of these agreements in 2008, are important milestones in the future programme for RE development in Hong Kong. It is clear that the requirements of renewable energy markets need to be taken into account if changes to the structure and regulation of the energy market are contemplated in the future, whether in the context of the SCAs or more generally.

The consultants have, in general, sought to develop solutions within the existing legislative and regulatory frameworks rather than propose root-and-branch reforms. Consultations suggested that complete reinvention of the framework for energy regulation for the purposes of supporting renewable energy was not credible at the present time - either for the energy companies or government - but was also, in all likelihood, unnecessary in the early stages of the market's development provided a number of key 'enabling' changes could be made.

Evidence suggests that considerable progress can be made in nurturing the early development of the renewable energy sector through incremental changes, while the broader policy positions on the future organisation of electricity supply, linkages with the mainland and other emerging issues are considered.

Renewable energy strategies must recognise the interests of the various stakeholders involved. Trade-offs are inevitable, but there are still opportunities to find 'win-win' solutions that satisfy the key requirements of all the major interests.

Within this broad framework, there are many different policy approaches. Box 12-1 shows some of the ways in which policy support has been used to assist the development of the renewable energy sector in some European markets.

Box 12-1: Policy and Legislative Frameworks to Encourage RE

The European Commission's White Paper on Renewable Energy Sources (1997) set out an objective to double the share of renewable energy use in the EU-15 countries from 6 to 12% of gross national energy consumption by 2010 (equivalent to a 22% share of electricity produced). In 2000, this was followed by a proposal for a Directive on renewable energy in the internal electricity market, which was recommended by the EU Parliament for adoption in July 2001. The directive aims to create a framework to facilitate medium-term increases in RE electricity production in the EU, through establishing national indicative targets for uptake of RE by 2010 by each member state, guarantees that national support schemes will be maintained for at least seven years and so maintain the confidence of investors, and provision of priority access to the grid for renewable energy projects.

National policies and support programmes have been implemented in all EU member states to complement the terms of the directive. Member states have differing priorities in terms of their principal reasons for supporting RE deployment.

Countries that do not have indigenous fossil energy resources consider RE as an important component of overall energy policy. RE provides a secure, indigenous source of energy that is available in a variety of forms, and can substitute for current conventional energy sources, both fossil fuels (particularly coal and oil) and nuclear. Using indigenous RE resources helps to reduce imports of fuel, and keeps investments in energy resources within the country. For example, Austria has few indigenous fossil fuel resources, so its energy policy strongly supports measures to improve the country's security of energy supply and to reduce the amount of energy imports. As part of this policy, Austria has a strong and long-standing level of active political support to renewable energy both at national and regional level.

RE is recognised as an important component of a country's overall strategy to achieve CO₂ emission reductions and thereby support compliance with Kyoto Protocol obligations. RE can play an important role in a more sustainable energy policy. Many countries are unable or unwilling to consider nuclear as a component of their energy mix, even though it does not produce CO₂.

Sweden: Swedish energy policy aims to support the development of conditions for efficient use and cost-effective supply of energy, while at the same time moving towards an ecologically sustainable society. An important component of this development is to implement measures to replace the electricity production losses (about 4TWh) from scheduled nuclear power plant closures from 1999 onwards. Expansion in the use of RE, together with energy efficiency measures, is the main means of achieving this.

Denmark: Denmark's 1996 Energy 21 energy strategy set targets to reduce CO₂ emissions by 20% by 2005 and by 50% by 2030 (compared with 1998 levels). (These targets are in line with IPCC recommendations for global reduction benchmarks). It focuses on a range of CO₂ reduction measures: energy savings, consumption of natural gas and oil stabilised, coal consumption abolished. For RE, this strategy aims to expand the use of RE to 17-19% of total primary energy consumption by 2010 (currently 10%), including energy from waste, and 35% by 2030.

Developing indigenous energy resources such as RE contributes to improving sustainable growth, creating more business opportunities and more jobs. This is particularly beneficial for rural areas, where secure employment may be limited. Jobs are created not only in construction, installation and maintenance, but also in manufacturing industries both for domestic markets and exports.

12.3 SECURING GRID ACCESS

Some part of the future stock of renewable energy projects is likely to come from third party sources, i.e. power generators other than the two existing electricity companies. Under the current Scheme of Control Agreements (SCAs), there is no obligation on the power companies to offer grid access to independent generators, although discussions to allow such arrangements have taken place and some progress is apparent. Ultimately, third party open access to the electricity grid can only be guaranteed through regulatory change to these Agreements.

Consultations and project promoters' experience indicate an apparent reluctance by CLP and HEC, founded on technical and commercial arguments, either to accept grid connection of sites providing non-utility owned generation, or to pay for any third party electricity exported to their grids. Within Hong Kong, there appears to be only one instance of a small generator (about 2MW) being connected to the grid: a landfill gas generator spills surplus power (about 4 ~ 6GWh per year) to CLP, but without payment by CLP.

For larger projects, where power is not absorbed by local site demand, access and export to the grid is essential to provide a market for electricity generated from renewable sources. For even a few percentage points of overall electricity demand to be met by RE, export to the grid is an essential requirement. Embedded sources (such as building-integrated PV) that primarily offset part of a given site's demand are unlikely to provide, even in aggregate, a significant proportion of the renewable energy contribution for Hong Kong as a whole.

Thus, significant RE targets are unlikely to be achieved unless most of the RE systems are connected to the electricity grid and receive revenue for their electricity outputs from the utility operators. These conditions cannot, at present, be met.

Even in the medium term, the various credible programmes for RE are unlikely to involve a total of more than about 100 connections, a sizeable proportion of which may be existing (connected) commercial buildings where BIPV systems are retrofitted. Nonetheless, this picture still indicates that a significant number of new grid connections are likely to be required for both small, embedded systems like BIPV and for larger "exporting" RE generation.

On the assumption that it is not realistic to expect fundamental reform of the SCAs in advance of 2008, the consultants have focused on how grid access can be addressed under the current regulatory framework. There is scope to reconfigure the current incentive structures to facilitate grid access, and address other barriers through agreement on appropriate technical standards.

The proposed strategy addresses these difficulties, and outlines the actions needed to address the real and perceived problems of grid connection. These can be divided into two broad categories:

- ❑ Those associated with the technical issues, capital cost and management of the process of obtaining grid connections, and secondly
- ❑ The absence of general arrangements with HEC and CLP to allow them to recoup the costs of renewable energy investments and to pay independent suppliers for any

renewable electricity exported into their systems.

Third party access to private grids is only of use if it provides access to a market for energy input, or to grid services (such as market balancing mechanisms, reactive power control, inverter synchronisation etc.). In Hong Kong, there may well be customers willing to participate in a market in renewable electricity, but unless at least bilateral agreement between independent generators and these customers can be realised such arrangements cannot operate. The role of the grid is central to this activity. Clearly this is a fundamental issue that is unlikely to be opened in advance of the 2008 SCA review. In the interim, it is useful to consider what practical steps could be taken towards using the private grid/power systems in a more limited role, solely focused on creating a market for renewable energy. There are several key issues:

- ❑ What are the costs of connection and can they be accurately assessed?
- ❑ Are power companies willing to become involved if most of these costs are sensibly supported?
- ❑ Are there real technical barriers that would prevent the technical operation of RE generation?

Of these issues, the most important is the identification of the true costs involved. In association with this, there is some merit in considering how these costs would be shared by power utilities and generators if there were to be large-scale RE generation, or if embedded generation was more widely promoted (perhaps through a DSM-type programme). The key issue here is whether power companies or generators should pay for the costs of “deep” reinforcement of the power networks. These matters are discussed in more detail in the Strategy.

12.4 CREATING A MARKET FRAMEWORK

12.4.1 Introduction

Grid access may be necessary, but alone it is not sufficient to establish a viable market framework for renewable energy technologies. This requires a number of additional barriers to be addressed, including:

- ❑ Awareness of renewable energy technologies in general, and the opportunities and benefits that they offer;
- ❑ Understanding of specific renewable energy technologies, and how they may be used in specific, relevant applications;
- ❑ High cost of some renewable energy technologies, particularly in relation to the value of the energy that they provide (cost-effectiveness);
- ❑ A higher level of risk (real or perceived) inherent in some renewable energy projects, for example in comparison with conventional power projects;
- ❑ Lack of an appropriate, accredited ‘supply side’ capable of designing and implementing

RE projects and providing (or sourcing) the most effective technologies;

- ❑ Issues relating to the planning and permitting of renewable energy projects, based on their novelty and the fact that their existence was rarely anticipated by the regulations (or regulators) involved;
- ❑ Inherent conservatism on the part of many (architects, financiers etc) who will play a part in deciding whether or not an RE projects actually goes ahead;
- ❑ Structural and institutional barriers, for example in the commercial sectors where project developers (who will pay the capital cost of an RE project such as BIPV) will not usually benefit from any income generated (for example, in reduced energy costs to the tenant).

The most appropriate response to these barriers will depend on the nature and scale of the technology and the status of its development and cost-effectiveness. For example:

- ❑ Small scale technologies such as BIPV demand an effective network of local suppliers, while large-scale projects like major wind farm developments are generally implemented by international companies and consortia;
- ❑ Technologies that are at an early stage in their development require R&D to improve their cost-effectiveness, while more developed technologies are better placed to compete in the market place;
- ❑ Where relatively well-developed technologies are not yet fully cost-effective, government support for early projects can help to 'kick start' the market and achieve the economies of scale that are needed;
- ❑ Issues of risk and conservatism are often addressed through demonstration projects and the promotion of independently-monitored results from those projects;
- ❑ Government can also act to reduce risk by removing administrative and institutional barriers, for example within the planning and permitting processes;
- ❑ Public awareness campaigns (locally or more widely) can also help to reduce public opposition to individual RE projects or more widely (a particular issue in relation to energy-from-waste).

Less developed technologies involve more risk, and here the focus must be on identifying and addressing the key components of that risk. The options available to government here include:

- ❑ Support for R&D to improve the performance and/or reliability of the technology;
- ❑ Support for demonstration projects and information campaigns to address (in particular) perceptions of risk that are not in fact born out in practice;
- ❑ Assistance with the identification and assessment of potential sites, in order to reduce site-related risks and uncertainties (including planning issues);

- ❑ Accreditation of technologies, suppliers and designers/installers/maintainers, together with the underwriting of performance guarantees;
- ❑ Public awareness campaigns to address perceptions of risk (e.g. environmental impacts) at a project-specific level.

More developed technologies involve less risk, and the economic viability of the application will become the key consideration. Here the options include:

- ❑ Support for demonstration programmes that involve a significant number of installations and which will therefore help to establish the market;
- ❑ Government 'in house' RE purchasing programmes and project initiatives;
- ❑ Incentive, grants, soft loans and tax breaks for RE project developers;
- ❑ Provision of favourable tariffs for specific RE technologies;
- ❑ Establishment of a renewable energy 'obligation' (% of power from RE sources) on utilities, with costly penalties for non-compliance.

Small-scale technologies in particular will require the establishment of a credible 'supply side' capable of implementing projects quickly and effectively. Options here include:

- ❑ Accreditation of technologies, suppliers and designers/installers/maintainers, together with the underwriting of performance guarantees;
- ❑ Tax breaks for supply side companies wishing to establish manufacturing facilities, distribution centres etc;
- ❑ Support for the preparation of project implementation and design guides, and their subsequent distribution/promotion.

Market stability is another important component of the necessary framework. This applies particularly to the regulatory and financial framework. Project developers need a 'bankable' income stream over several years in order to raise finance for the project, and it must also be clear that standards will not be arbitrarily increased in a manner which imposes additional 'downstream' capital costs.

12.4.2 Supply Side Issues

As highlighted above, the key to the emergence of a viable renewable energy sector is creation of a stable investment climate and the conditions necessary for a market to function. Hong Kong is at the start of this process, and it is inevitable there are some important issues to be addressed.

CLP and HEC's policy towards renewable energies is evolving, but very much framed within the context of Hong Kong's existing energy policy and the Scheme of Control Agreements. As would be expected given the given operating framework, they have focused on providing electricity (a) from their own generating sources (b) at lowest cost,

through development of large-scale conventional power plants. Discussions with the power companies indicate a willingness to adopt and support renewable energy, but contingent upon changes to the regulation environment in which they are obliged to operate.

Investment by CLP and HEC in additional generating capacity (evaluated by EDLB and requiring the approval of the Government) is triggered in advance of a capacity constraint being reached. As elsewhere, the power companies therefore operate with a safety margin of surplus generation capacity. In these circumstances, and with fully integrated systems from generation through to retail distribution, there is no need or incentive for the companies to purchase power from third parties within Hong Kong (unless perhaps such power was available at less than the marginal baseload generating cost – a challenging requirement). Third party assets would fall outside the scope of the asset base used in the calculation of the companies' Permitted Return¹.

There is currently no established practice or precedent of independent power producers selling power to distribution companies or directly to customers. Aside from meeting their own independent energy needs, project promoters are in effect only able to offer their electricity to their local power company – HEC or CLP.

There are no terms in the Scheme of Control Agreements setting out the basis for power purchase by CLP or HEC from third party producers (the SCAs are not franchises or exclusive arrangements). Not surprisingly, the SCAs do not specifically mention renewable energy sources, and do not place obligations on the power companies to buy such renewable energy as may be generated in the areas under their jurisdiction. The reader may recall the preamble to the SCA and its requirement that power is, 'provided at the lowest cost which is reasonable in the light of financial and other considerations'.

In similar vein, there is at present no mechanism for the power companies to recover from general tariffs the additional costs that may be associated purchase and re-sale of renewable energies from third parties. Nor is there provision in the SCAs for 'green power' tariffs for renewable-sourced electricity to be offered to the market.

The compulsion on utilities or energy suppliers to deliver a given percentage or specified volumes of energy from renewable resources underscores most renewable energy support programmes overseas. This statutory obligation does not exist in Hong Kong and the financial aspects of the power sector are regulated by contract (the SCAs) rather than by statute. There appears to be little prospect of introducing an obligation in Hong Kong before 2008 and so the consultants have thus explored how a renewable energy market could be created in its absence.

International experience of renewable energy purchase exhibits a wide diversity of support arrangements, reflecting the wide range of degrees of liberalisation of energy markets and the degree of implementation of renewable energy. The form of financial support for RE typically evolves as the sector develops, but also depends on the main technologies involved and their status of development in technical and economic terms.

¹ There is scope for exceptions to this general rule – e.g. CLP's interest in the Daya Bay Nuclear power station in Guangdong is not included in the ANFA calculations. Daya Bay power is accommodated through CLP's power purchase expenses being included in the operating expenses that are taken into account in the setting of tariffs.

Many RE programmes start with the obligation on utilities to absorb and then deliver specified volumes from identified RE technology types. These arrangements are often supported by a levy on customers that is then recycled into support mechanisms for, say, hedging prices paid to renewable energy generators. As the programmes mature, the obligation to deliver specified volumes of renewable output is maintained, but the technology choice is left increasingly to market forces (backed up by certification schemes) and the level of levy on customers is reduced.

This evolution has stimulated the development of wind power and other technologies but has involved the initial offering to developers of unit purchase rates that are significantly higher than market prices. Over time, with improvements in the technology, greater experience of the applications, reduced risk and economies of scale, tariff levels can converge on the lower (market) rates, even where the longer-term support contracts with the RE generators are maintained.

12.4.3 Demand Side Issues

Public attitude towards new and renewable energy sources is an important determinant of a successful renewable energy programme. Renewable energy technologies can challenge popular perceptions of acceptable land uses, and of the trade-offs between global goods and local environmental impacts. A classic example here is the visual impact of wind turbines in rural landscapes. Furthermore, to the extent that renewable programmes require financial assistance and that subsidy is funded through general or opt-in electricity tariffs, the public's willingness to pay for clean 'green' energy is a critical success factor.

The consensus from consultations was that public knowledge and understanding of renewable energy is at a relatively low level. This is understandable, given the limited exposure that most people in Hong Kong will have had to renewable energy sources and projects. While the conventional power stations are all too visible, most existing RE projects have been LFG schemes safely hidden away on landfill sites or PV demonstration projects fixed to relatively obscure university, corporate or government buildings. The 'demonstration' impact of such projects on the public has probably been modest at best. The activities of Friends of the Earth are perhaps the most notable exception to this general rule, with the initiation of the wind measuring station on Po Toi attracting much press interest, the development of the Earth Station project and other events such as a solar car race also being popular.

If it is too early to expect support for RE from the general public, the position in the corporate sector is less clear cut. On the one hand, business in Hong Kong is generally perceived to be highly cost-conscious, especially at the small and medium sized enterprise (SME) level. On the other hand, a number of key sectors of the Hong Kong economy are dominated at their upper levels by only a few firms, examples being banking, property and retail development, and public transport. Some are major power consumers (e.g. MTRC, KCRC, the major property firms). In some cases these firms, being closer to international shareholder pressures for greater corporate social and environmental responsibility, have well developed energy and environmental policies. The scope for successful marketing of green power tariffs to such companies is undetermined, but perhaps more promising than with the general public consumer. The following quotation from an MTRC corporate environmental report illustrates this distinction:

“At present, since MTRCL cannot choose to obtain its electricity from non-polluting sources, about 1% of the emissions from the power stations which supply our electricity are in effect, the Corporation’s emissions”.

The opinion section of the same report continues,

“As a major user of energy it would also be desirable if the Corporation could promote greener supplies of energy such as renewables, either by using its influence in the energy supply market, or by exploring other ways of generating power in its own operations.”

Perhaps the most interesting aspect of a demand-side analysis of power consumption in Hong Kong is the significance of government power purchases. The consultants were not able to obtain a complete inventory of power consumption by all government facilities, but the data collected and anecdotal evidence suggest the government is the largest single power consumer in Hong Kong. Government Purchasing Agency data on shared office buildings alone suggest an annual consumption of 303 GWh, worth HK\$256M in 2000-2001. To this must be added WSD consumption (WSD is understood to be a very large power consumer), Housing Authority purchases, and those of EPD, DSD, Education Department, and the numerous other departments that operate all manner of sites and facilities. Data made publicly available by CLP show that Government accounts absorbed 24% of the company’s Hong Kong electricity sales in 2000 (see *Table 12-1*). With this background, precedents set by governments elsewhere who have applied apply environmental criteria to their electricity purchase contracts begin to look interesting.

Table 12-1: Composition of CLP’s Electricity Sales in Hong Kong by Customer Type, 2000

Customer Type	Power Sales (GWh)	Percentage
Commercial	10,014	38%
Residential	6,608	25%
Government	6,197	24%
Manufacturing	3,488	13%

Source: CLP Annual Report, 2000.

12.5 SECURING FINANCIAL VIABILITY

12.5.1 Introduction

All RE schemes need revenue to provide a return on the investment involved – there needs to be a means of selling the power, and achieving a price sufficient to cover costs and a margin of profit. The financial objectives to be achieved may be prioritised as follows:

- *Establish a mechanism through which an income stream can be generated*

The assumed starting point is one where the basic issues of connection and connection charges are resolved. The renewable project, whether a third party scheme or developed by an existing power company, is in a position to offer power for sale at a given price. The challenge is to meet that price in the Hong Kong situation where the conventional power displaced is likely to be cheaper for the electricity company and for consumers, and where there is no obligation on the electricity companies to generate or purchase renewable energy.

The first step required is definition of a fair reference price and agree mechanisms for setting the renewable price paid for renewable energy. The second necessary step is development of a mechanism to finance the price gap. These two issues are discussed in detail in a later section.

- *Ensure that that income stream is fair and equitable, particularly in comparison with conventional (fossil fuel) generation projects*

The differential between conventional electricity and renewable electricity can be reduced by complementary measures that increase the cost of conventional sources of energy. Common examples are pollution taxes levied on the combustion of fossil fuels (e.g. carbon tax). The analysis that follows assuming that the current status quo in Hong Kong remains, i.e. that there is no carbon or sulphur tax regime. The introduction of such measures would clearly improve the comparative position of renewable energy sources.

- *Ensure that the income stream is as stable as practicable, in order to be 'bankable' as far as project developers are concerned;*

A key issue in terms of stability of income stream and project 'bankability' is the expiry of the Scheme of Control Agreements in 2009. Given that most major renewable projects in prospect will take years to develop, and that the future of Hong Kong's electricity market beyond 2009 is at present undefined, this factor must be addressed in the design of the support mechanisms identified.

- *Consider whether contributions to capital costs or public purchasing programmes are also needed to offset risk and help achieve economies of scale;*

For BIPV technologies export of power to the grid is likely to be limited. Revenue support mechanisms suitable for larger schemes (e.g. wind farms) may not therefore be sufficient to encourage up-take and instead assist with capital cost financing may be appropriate.

At the early stages of the development of the renewable energy sector, it may be appropriate for Government to take a pro-active role to support renewable energy sources. Options include underwriting demand for renewable energy by offering to purchase certified renewable electricity at a given set of prices. As government is the largest power purchaser in Hong Kong, this is a potentially powerful mechanism to stimulate demand and pursue green procurement initiatives. Options are discussed later in the chapter.

- *Consider whether support for R&D projects will contribute to improving performance and cost-effectiveness to the level where projects are commercially viable.*

Renewable energy technologies are evolving and new applications, as yet unproved, are being tested. R&D funding can play a useful role in keeping Hong Kong up to date with emerging technologies of interest.

12.5.2 Determination of Reference Prices for Power Purchase

One of the first steps towards establishing the conditions for financial viability of renewable energy projects is establishment of a reference price for the cost to the electricity company of a kWh of electricity, a price against which the delivered cost of renewable electricity can be

measured. In those countries where electricity from different conventional power stations is traded in an open market this is relatively straightforward because a central 'pool' price or marketing clearing price is available. In Hong Kong that visible reference point is absent and an alternative measure must be determined. In doing so, a useful distinction can be drawn between large projects, and small scale embedded renewable energy generation.

Large RE Projects – Power Exporters

Large generators of RE are in a position to export electricity to the grid. Some have highly predictable output (landfill gas, fuel cells) while others less so (even then, some are more stable and predictable than others: for example, solar generation compared to wind generation). The value to grid operators and electricity suppliers of such outputs depends on numerous factors, the principal ones being:

- ❑ The avoidable energy/fuel costs of accepting such output into the grid system
- ❑ The effect on long term provision of generation, transmission and distribution capacity
- ❑ The costs of metering these sources
- ❑ The costs of routine administration and acceptance of such sources' connection to the grid.

A power company should be prepared to offer, at the very least, a price up to the value of the short term avoidable energy cost of its conventional source less costs of metering and administration etc., and possibly modified for the longer term effects on generation, transmission and distribution costs.

Many of these costs are reflected in the time-of-use tariffs that are now offered to Hong Kong's bulk customers. These tariffs reflect the cost of conventional generation and delivery to customers, and suggest the scale of avoidable costs for these circumstances. For example, the CLP ice cooling air conditioning tariff provides a charge for the energy component of about 60 cent/kWh (off peak) and 68 cent /kWh (day), in addition to capacity charges of \$26/kVA-month and \$66/kVA-month for supplies to the for electricity supplied. While such costs may be insufficient to support RE projects, they reflect the scale of the conventional costs against which RE competes, and hence provide a datum against which to assess the scale of supplementary funding/support that may be needed.

A comparison of time of use tariffs for both sale to customers and purchase from customers is shown in *Figure 12-1*, based on information from an electricity utility in the UK. This utility serves demand of a similar scale to Hong Kong, and delivers electricity that is generated from a generation mix based largely fossil fuel, with some nuclear base load, and with pumped hydro peak management. Whilst the demand pattern is related to UK climate, there are comparable factors to Hong Kong: there is a peak and a seasonal component, and the grid systems operate at similar voltages with, to a degree, similar topology, engineering design arrangements and standards.

The practice, which is typical for many European utilities, is to buy in generated electricity at about 75% of the time-of-use price, but to make additional allowance for the savings in

system losses (of the order of 3% extra). There is also an allowance for reduced electricity market trading costs (an administrative costs not relevant to Hong Kong).

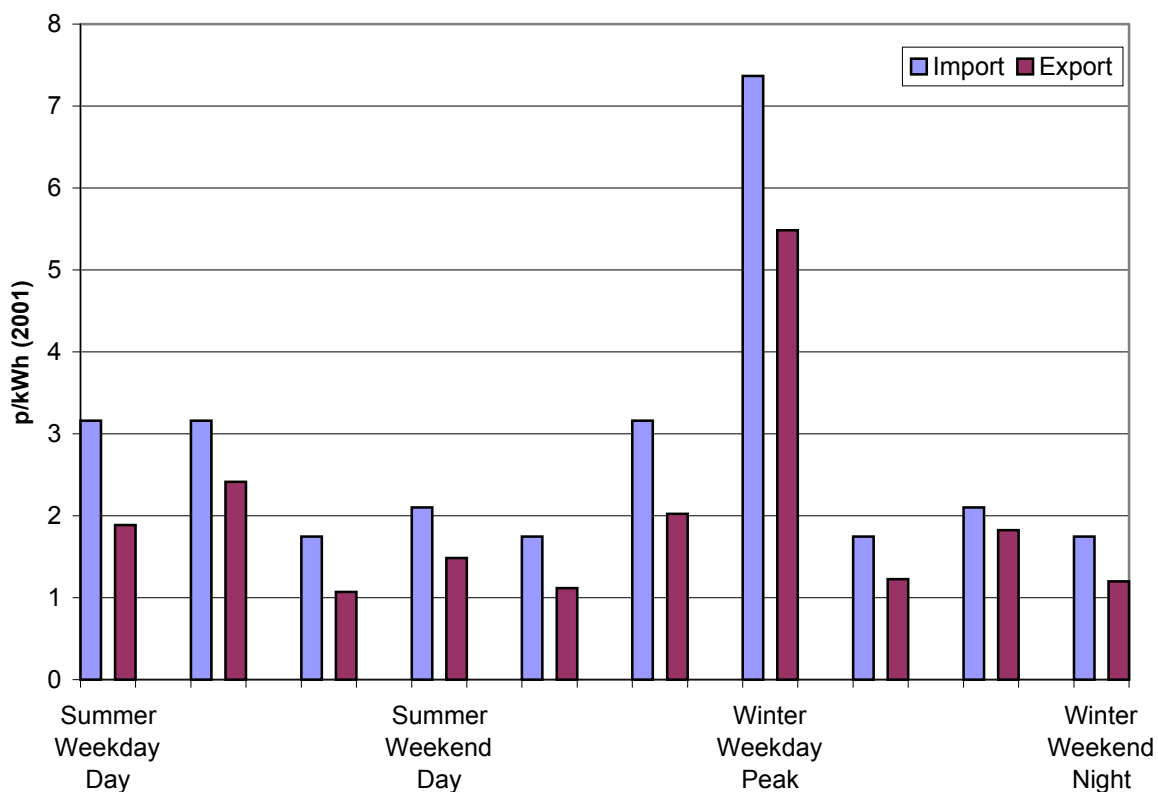

Note: y-axis units = UK pence/kWh. 100p = HK\$11.3

Figure 12-1: Time of use tariff for Supplies to Large Customers and for Purchase of Electricity

This analysis indicates that there are numerous examples where suitable tariff structures have already been established. Buy-in prices of about 80-90% of the standard retail prices offer a fair compromise between economic compensation and commercial prudence without damage to the commercial position of the utility company involved. However this is often in the situation where the purchaser is subject to an obligation to achieve a certain level of renewable purchases, rather than just to purchase all such output.

However, where plant offers firm output for many years – such as municipal waste incineration and landfill gas – the plant effectively becomes a component of the locality’s generating system’s portfolio of plant. As such it off-sets capacity and energy costs, and similar plant. For increments or decrement of demand, the time of use tariffs provide a proxy for market prices. After administration costs and profit margins it is therefore not unreasonable to expect grid operators to pay, say, 80% of retail tariffs. This revenue stream may in itself be insufficient to make early projects viable; the additional support mechanisms that could be used are discussed in later sections.

Simulation of competitive market trading arrangements would be ideal for less predictable sources such as wind power. In systems where significant wind power exists, local utilities

provide pooling and settlement, and purchase prices are not much reduced from those for exports from conventionally reliable plant (such as land-fill generation).

Small RE Projects – Embedded Generation

The tariff issues for small, embedded active sources (such as building-integrated PV systems) are different to those of the large exporting schemes (such as energy-from-waste projects and wind farms). For most small renewable generation, the power generated is likely to be absorbed within the installation's site demand, and even in the situations where export is theoretically possible, its commercial value will be less than the extra costs of metering. Instead, embedded users may assess their investment against the revenue savings made, rather than the income from power export. The revenue savings offered by embedded schemes are determined by the cost of power that would otherwise have to be bought from CLP or HEC.

How much is this saving worth? Domestic customers are offered standard rates that increase with consumption levels: above a basic consumption level (of 340kWh/month with HEC or 400kWh/month with CLP) the tariff rates are HK\$1.066/kWh and HK\$0.93 cent/kWh respectively (before minor adjustments for fuel cost etc.). Savings in consumption therefore save customers about HK\$1/kWh in round terms.

Commercial customers of HEC are offered a flat rate of \$1.106/kWh, in CLP the general service rate is 97.4 cents/kWh up to 5000kWh/month, and 96.4 cents/kWh above this level of consumption. Again, savings in consumption save customers about \$1/kWh in round terms.

Thus small embedded generation can be credited with customers' avoided costs of around HK\$1/kWh of production, all other factors being unchanged. Such tariffs do not however reflect the distribution over time of the time-wise profile of the costs of production, and hence do not provide a transparent commercial message to generators as to when it is most advantageous to power companies for others to provide generation, or for customers to reduce demand.

Time-of-use tariffs do provide such messages. The publication of such tariffs would promote the optimisation of customer demand by the use of PV or renewable generation, or by demand reduction measures. Such optimisation is already supported by the DSM programme that has advanced the trial of time-of-use tariffs.

Arrangements for Metering and Billing

For large installations the information gathered by metering is of much greater commercial value than the costs of its collection. Standards for metering need to be made transparent to developers. A public protocol on the technical standards, administration and charges for operating and maintaining metering would assist developers in assessing the viability of their projects. Protocols for the use of meter data would be similarly useful.

International experience is that for large generation, import and output metering is necessary for commercial reasons. However, for very small-scale generation there are few examples of net metering. Where these do exist, the incumbent grid operator providing support to small generation schemes carries the cost.

Normally little or no price is paid for electricity exports from very small schemes. Also, many utilities are reluctant to allow any meters that are able to operate in reverse, for fraud protection reasons. Both of these factors militate against offers of net metering.

In the United States, net metering is an accepted concept in most States. In the UK, one utility has committed to net metering for up to 1000 domestic customers on a trial basis for five years, and the company voluntarily bears the costs of such support. The system is supplied on standard domestic tariffs (there is no special arrangement), and the trial uses electronic meters (originally produced for fraud detection). The billing and administration of the scheme is part of the trial's monitoring at present.

The power companies may wish to support renewable energy technologies by a limited use of new metering arrangements. Some utilities have offered a limited trial of such arrangements. However, for the majority of small and medium embedded generation developers, providing options (either simple metering or more complex electronic export metering with associated feed in tariffs) should be encouraged, but on the basis of true/fair costs agreed with the government.

Section Summary

- ❑ Reference prices for renewable energy purchase by the power companies of third party power should be determined by reference to time-of-use tariffs.
- ❑ It would be reasonable for these rates to be set at 80% of the relevant time-of-use tariff.
- ❑ Metering protocols will be required for renewable projects that export power. Different protocols may apply to projects of different sizes. Grid companies should consider offering limited use of net metering arrangements for smaller installations.
- ❑ Grid companies may wish to consider fully incorporating more conventional sources such as landfill gas and incineration plant in the planning of their longer term plant capacity planning on the proviso that Government support to these will effectively make purchase of the output and economically attractive option, and/or will form part of a future renewable purchase obligation.

12.5.3 Supplementary Support Measures

Resolution of the connection arrangements and reference tariffs issues discussed above is unlikely to be sufficient in itself to stimulate RE technologies. Some commitment to special support arrangements will be required for a significant period to help provide RE project developers with a stable and rewarding financial environment, and encourage participation by the two electricity companies.

The existing incentive structures on the power companies and on prospective project developers will need to be adjusted if RE projects are to be 'bankable' in Hong Kong. There are a number of ways in which that might be achieved. The principal options and their attributes are outlined below. They are not all mutually exclusive and a combination of approaches may be appropriate. Also, the nature of the support may change over time as technologies mature and production/implementation costs converge to "commercial" levels.

Option A - Renewable Energy Projects as Allowed Assets under the SCAs

The present Scheme of Control Agreement structure provides the power companies with a rate of return on assets employed. Generating capacity is justified as being required to match future demand. If power companies owned RE generation (such as a wind farm), it could be treated as such an asset, if the regulator (government) agreed that the capacity was justified, and that the RE capacity met the criterion of 'lowest reasonable cost'.

The advantage of this approach is that SCA structure may not need modification or supplementary agreements negotiated. The power company can earn its standard rate of return (as set down in the SCA) on the renewable energy assets if existing rules are interpreted as suggested above.

An additional advantage is that there would be no requirement for a renewable levy or green electricity scheme for the project since the operating costs would be factored in during the calculation of standard electricity tariffs as happens today. The pricing consequences of bundling RE projects into average net fixed assets (ANFA) calculations would be borne by customers, but would be averaged out across all consumption. Given that the first round RE projects developed by the power companies before 2009 are expected to be very small compared to overall capacity the price effects would be expected to be modest.

Whilst straightforward, the model is not fully optimal for the power company. A wind farm (for example) would be marginal for the power company in the sense of being high cost relative to other possible sources of power. With the wind farm included, the average asset value would rise but it would do so by less than the marginal asset value (the incremental change in asset value). Accordingly, the return on it would be below the target return, which is based on the average. Unless the power company was willing to accept this deficit for the purposes of pilot projects, an additional financial incentive would be required – such as a contribution to the capital costs of the project from a renewable energy fund supported by government or funds from consumers.

Other limitations of this model include that:

- ❑ this approach is restricted to projects that are owned by the power companies – third party RE projects could not be included.
- ❑ the applicability of this approach beyond 2008 is unknown – since the regulatory system beyond 2008 is undetermined.
- ❑ participation by consumers is non-elective, i.e. there is no opportunity for consumers to opt in or opt out of funding the renewable energy projects.

This financing model appears best suited to application in the 2003-2009 as a means of bringing selected pilot projects into operation.

Option B - Renewable Energy Levy

A renewable energy fund, fed by a levy on electricity customers, could be used to meet the additional costs of purchasing power from certified renewable energy projects over and above a set of reference tariffs. The fund would support purchase of power from RE projects

from third parties and 'internal' RE projects developed by the power companies. CLP/HEC-owned projects would require separate accounting. Arrangements would be affected by whether the assets were excluded from the asset base on which Permitted Return was calculated.

A mechanism for certification of renewable energy projects would be required, and a verified metering process. Also required would be a reference tariff against which the additional costs would be measured. The total tariff rate relevant to each project would also need to be set - either on a case by case basis in advance of project development (and approved by the regulator), or by Government setting approved tariff rates for individual technologies.

Overseas, many schemes for the support of renewable energy generation have started with the application of a general levy on electricity customers, often reflecting a target for the development of a level of grid connected renewable energy generation. The levy may amount to several extra percentage points on standard electricity bills. The revenue collected is used to provide financial support for RE projects.

As the RE technologies become established, the levy support to new projects is reduced, perhaps being replaced by more general obligations on suppliers to source a certain percentage of their supplies from renewable sources, or to demonstrate green certificate compliance on a wider scale. Conceptually the levy might also be used for the development of demand-reduction techniques if these also involve renewable energy (e.g. PV).

A levy of 1-2% (1-2 cents) has proven to be acceptable to most people on the basis of experience elsewhere, although in Hong Kong the approval process to put in place this levy may be more difficult than in other countries. Moving up, 3-5% (3-5 cents/kWh) could perhaps be achieved, while 6-10% would only be acceptable to a minority. These might be low, medium and high scenarios (for levy). Assuming an average consumer price of 1.0 HK\$/kWh, even a 1% levy on all household and commercial electricity bills would, in 2000, have raised almost HK\$350 million - sufficient for a sizeable renewable energy fund and probably well in excess of what would be required in the early years of the strategy.

Option C - Extension of the DSM Model

The Demand Side Management Scheme agreements provide precedents for the integration of what could be regarded as 'un-commercial', but socially desirable activities, within the framework of the Schemes of Control Agreements. The agreements recognise that the DSM scheme has identifiable costs to the power companies, and provide mechanisms for these costs to be recovered. They also provide an important signal that the companies are willing to undertake such activities if profit margins are protected to a reasonable extent.

The DSM agreements provide detailed mechanisms for partial compensation of CLP and HEC for undertaking such 'un-commercial' activities, and incorporate algorithms for the calculation of the costs. These costs are levied as an additional cost (about 1%) on a defined set of customers. There are limits on the liabilities for cost of operating the schemes. The DSM charge levied on electricity consumers by the power companies is on a cost recovery basis to cover the running cost of the DSM programmes, without any compensation to the power companies.

The two power companies forgo some allowable profit to maintain the DSM programme, which is currently in place until 2003. Both companies consider their involvement as a demonstration of their commitment to environmental objectives, and the stimulation of the use of RE should be considered as a logical extension of this commitment.

The DSM programme:

- ❑ establishes the acceptability of the concept that grid operators should not be unduly commercially disadvantaged by integrating independent sources into their power systems.
- ❑ indicates that a sensible message is that purchases founded on power system avoidable costs are a reasonable basis for such future agreements.
- ❑ established a precedent in Hong Kong that some positive discrimination in favour of environmental benefits can be integrated into existing SCAs.

Stand-alone active renewable sources like BIPV act to reduce customers' electricity demand - and reduce purchases of electricity at higher (retail) costs. This embedded small generation acts as an energy conservation mechanism and one might consider extending the DSM scheme model to cover this form of RE. A new specific sub-set of the programme (or sub-set of the existing programme, if extended), with an allocated budget, would be required in light of the fact that BIPV scheme may well have longer payback periods than alternative energy conservation measures and as such would not otherwise receive DSM "rationed" funds, and that the future of the existing programme beyond 2003 is undetermined.

It is necessary to consider technology-specific funding, even in the DSM programme, as a means of promotion of the option. This is a development beyond the establish principles of the DSM programme - now only using the mechanism for support, but not the "cost-effective energy efficiency" route.

Building Integrated Projects (embedded generation) could be defined to include BIPV, BIFC and CHP (cogeneration). All these energy supply technologies help to meet the building's energy demand, so reducing net consumption (from grid). Energy saving measures (within DSM) are controls, insulation etc that reduce demand as the means of achieving the net consumption. It follows that the two approaches (supply and demand) projects can easily be considered separately and indeed complement each other. In practice, it would be best to consider supply measures only where demand reduction has already been achieved (demonstrating efficient RE supply technologies in an inefficient building conveys the wrong messages).

Cost per kWh delivered is quite high, but because projects are small this is not necessarily inconsistent with the 1% levy already in place. From the perspective of the utilities it will generally be better (more cost effective) to invest in energy saving measures rather than BIPV or BIFC.

Option D - Green Electricity Scheme

An alternative mechanism to finance a renewable energy fund is a renewable ('green') electricity tariff scheme. Around the world there are numerous examples of such schemes, under which electricity from certified renewable resources is hypothecated to customers who volunteer to pay higher tariffs (typically 10 ~15% more) to ensure that most of their consumption is from renewable sources. The key aspect of this funding mechanism is that it is an 'opt-in' arrangement in which consumers that wish to purchase energy from renewable sources volunteer to participate in the scheme.

Figure 12-2 illustrates the key issues involved for a conceptually simple green tariff arrangement where the intention is that there is a group of customers (individuals and/or Government for example) wish to purchase "green" electricity: in this elementary arrangement, renewable generation's output is purchased by a power company, and sold on to customers willing to support a renewable premium. Green electricity schemes can be simpler to administer and manage than large levy arrangements, although they are not without practical concerns with regard to the fair support and allocation of the costs involved.

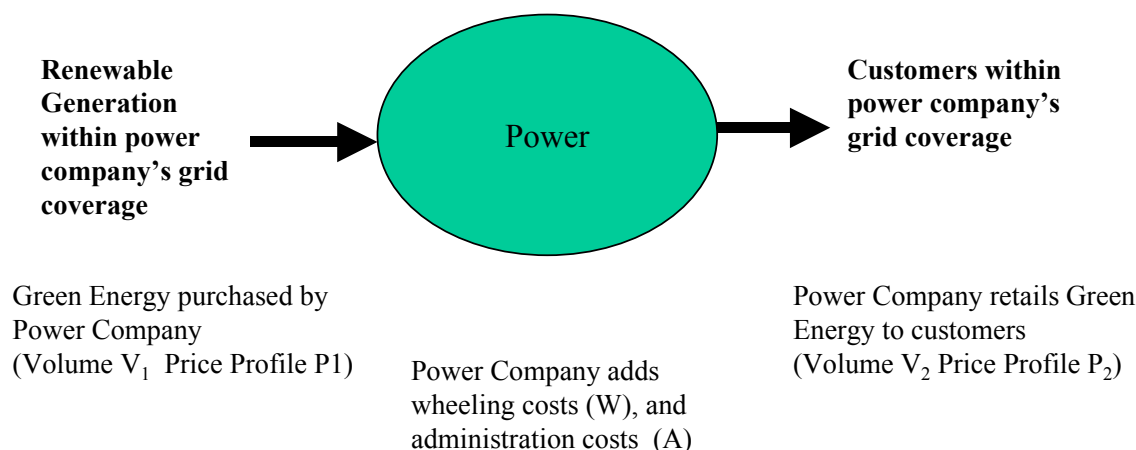

Figure 12-2: Basic operation of a Green Electricity Scheme

In liberalised markets, the tariff is simply offered under market conditions to customers (which may be typed an 'unregulated' model). The arrangement can co-exist with either statutory or voluntary agreements for power companies to take a guaranteed level of renewable output. Indeed, the existence of customers willing to pay a premium complements the statutory or voluntary commitments to take a certain level of renewable energy into a power portfolio.

There is a number of regulatory issues related to identifying proper payment for use of grid systems, but these are not insuperable. In Hong Kong, the SCAs do not specifically exclude the possibility of CLP or HEC offering such tariffs, and there appear to be no matters of basic principle that would act as fundamental barriers to the development of green tariff offerings by either HEC or CLP.

The expedient solution to establishing a green electricity market would be for both power companies to be encouraged to offer green tariff or contract arrangements. Much of the

discussion can be expected to revolve around the commercial risks and costs of providing this facility – this is discussed below. Although an ‘unregulated’ scheme could, it appears, be launched in parallel to the SCAs, the fact that Hong Kong is at the beginning of the path of renewable energy development, and the nature of the current electricity regulatory system suggests that a ‘regulated’ model in which arrangements are codified in agreements between government and power companies may be more appropriate.

Willingness to pay for ‘green power’ in Hong Kong is uncertain at the present time. As suggested earlier, there are signs of interest in the corporate sector and Government power purchases could easily absorb all power from renewable sources currently under consideration. Prudent initial steps would be to conduct a survey of the corporate sector to determine interest in a green power scheme and for Government to examine the feasibility of sourcing a proportion of its electricity via a green power scheme.

Even in the simplified arrangement shown in *Figure 12-2*, several questions commonly arise in relation to sharing and the distribution of revenue and volume risks in an evolving market sector, as summarised in *Table 12-2*.

Table 12-2: Issues related to Green Power Scheme

<p>How do customers and regulators know that V_1 units have been absorbed by the Company?</p>	<p>A government certification scheme, or power company declaration of meter readings is usually adopted under new rules on these matters.</p>
<p>What are the company costs W and A, and how are these guaranteed to be fair?</p>	<p>Government review of pricing policy needed – this may involve discussion of the principle of what constitutes uneconomic operation of displaced conventional generation, but DSM negotiations provide some precedents.</p>
<p>How are Power Company’s purchase costs properly reflected in the Green Tariff? Who polices the costs of output “purchased” from the Power Company’s own RNE sources?</p>	<p>In many countries, such company owned generation ventures are required by regulation to operate commercially separate from the main company, and the price of exports from these generators are then bid competitively against a declared volume and technology requirement set by government or by the market. An independent government organisation oversees the process of bidding. Thus the government steers the development of the market.</p> <p>Alternative arrangements for shadow pricing include using the prices offered by independent generators.</p> <p>SCA arrangements for generation in excess of normal capacity requirements disallow capital costs to be included in the asset base. Is this a mechanism for compensating for support to RE?</p>
<p>What happens when there is an imbalance of purchase costs (“$V_1 * P_1$”) and supply revenue (“$V_2 * P_2$”), after allowing for wheeling (W) and administration costs (A)?</p>	<p>Depends on maturity of market.</p> <p>Under full free market conditions, the energy trader takes the market risk – either of losses or profit. The grid operator makes a margin on normal wheeling charges, irrespective of the energy trading risk.</p> <p>In HK, the underwriting of revenue risk to RE generators would be the subject of negotiation with power companies and government and RE developers. The degree of risk</p>

	absorbed by each stakeholder depends on the shape of the retail green tariff.
What happens if there is an imbalance between V1 and V2 (after losses are accounted for)?	<p>If certified production exceeds measured customer demand after grid losses, there is no problem with respect to the Green Tariff obligation – it will be providing 100% “green electricity”. The surplus is treated as a revenue risk issue as above. Also, if the government agrees to take any unabsorbed V₁ at the premium price, then there will be no imbalance.</p> <p>If production is less than natural customer demand, some rationing (by the Power Company) needs to be considered, or some degree of balancing using conventional supplies might be considered if the balance within normal forecasting errors.</p>

In developed green tariff systems, green certificate costs are mechanisms for power companies to signal that they have committed resources to certified renewable consumption. These are, in effect, a mechanism for including renewable development within the green tariff. This may be a route for the promotion of renewables outside HK geographic area, or perhaps for HK Island customers to support renewables within the New Territories boundary.

Examples of overseas use of green electricity tariffs include Sweden, the UK, and a number of US states. In Sweden’s deregulated electricity market, energy suppliers offer different tariffs for different sources of energy. For example;

- ❑ Sydkraft AB is the largest electricity producer in Sweden. Electricity production is based on hydropower, nuclear power, fossil fuels and wind energy. Tariffs vary from 0.015 SEK/kWh from hydro power to 0.050 SEK/kWh from wind power.
- ❑ Vattenfall Energimarknad AB supplies electricity, district heating and energy services. Electricity production is based on hydropower, nuclear power, CHP and wind energy. The tariff for hydro power is 0.025 SEK/kWh to 0.038 SEK/kWh for wind energy.

Recent changes to the organisation of renewable energy finance in the UK have seen individual energy suppliers offering a variety of different green tariffs.

- ❑ One company provides a 100% renewable electricity services to domestic and corporate customers in which the price of the energy depends on the region of the country. Average domestic bill is expected to be around £3 (HK\$34) a month higher on this tariff based on average domestic household consumption of 3,300 units per year on a standard domestic tariff.
- ❑ 'Juice', is marketed by energy supplier Npower in partnership with environmental NGO Greenpeace. It will enable 50 000 domestic electricity customers to receive their electricity from clearly identified, renewable sources at the same cost as any other Npower customer. Juice will allow residential customers anywhere in the UK the opportunity to purchase clean electricity generated by the wind at sea.
- ❑ ECOPOWER is Eastern Energy's green energy scheme for domestic customers. It has been running for over three years. Customers who choose ECOPOWER pay an extra

50p (HK\$5.7) per week (excluding taxes) on their electricity standing charge. This money is held in an independent fund. This fund is used to award grants to renewable energy projects.

- ❑ London Electricity is marketing renewable energy to its domestic consumers under a renewable energy tariff 0.4p (~ 4.5HK¢) higher than the standard domestic rate.

Option E - Direct Government Guarantees and Finance

The options above have discussed various models of renewable energy finance, all involving electricity consumers being obliged to pay the incremental costs (e.g. levy arrangement), or electing to do so (green electricity scheme). There is also scope for direct public finance to be used in place, or in supplement to electricity consumer funding.

The general levy option would, in effect, involve some public funding in that the government is Hong Kong's largest power purchaser and would thus pay the renewable supplement on its power. However, if the implementation of a general levy was not feasible and a simple green electricity tariff too uncertain of success, the incremental costs of support to renewable energy could be, in principle, supported in full by public (government) funds through an annual subvention to the renewable energy fund. While providing short term security of finance and avoiding some of the implementation issues with the sale of the idea of general levy to the public, this clearly has a number of serious disadvantages:

- ❑ Long term financial sustainability
- ❑ Lack of adherence to the polluter pays principle
- ❑ Lack of engagement with electricity consumers
- ❑ The opportunity costs of public funds that could otherwise be allocated to other uses.

Direct support could be used far more constructively and creatively by extending the government's green procurement programme to renewable electricity. The government is in a position to participate in the green electricity scheme as a significant player, creating demand and investor confidence in the early stages. If necessary, the government would be in a position to be able to underwrite the scheme in full since its overall power consumption is well in excess of the renewable energy sources in prospect in the medium term of the strategy (2004-2009). This would remove the demand side risk associated with the green electricity scheme.

Initial investigations, including consultations with ETWB, suggests that whilst there are issues to be examined, there are no fundamental reasons why the purchase of renewable electricity cannot be accepted, even if there is a price premium, in the same manner that government buys recycled paper that is more expensive per ream than 'standard' paper.

Governments elsewhere have undertaken to source 5%, 10% or more of their electricity from renewable sources – either by central mandate or by requiring individual departments and agencies to set targets for renewable energy and enter into contracts with RE suppliers accordingly:

- ❑ **Australia:** In May 2000, the Australian Government approved a Renewable Energy Action Agenda under which it will support the promotion of renewable energy technologies and green power in Commonwealth departments and agencies in order to signal the benefits and raise awareness and confidence in renewable energy. Twelve Commonwealth agencies already buy green power including the largest Commonwealth energy user, the Department of Defence, and more agencies are in the process of making a formal commitment to buy energy from renewable sources. This voluntary commitment to buy Green Power is achieving greenhouse gas saving of 35,000 tonnes per annum. It is estimated that if extended across all agencies, the Commonwealth could achieve greenhouse gas reductions of 175,000 tonnes.²
- ❑ **UK:** The Green Ministers Committee has agreed that all government departments will ensure that, by 31 March 2003, at least 5% of their electricity comes from renewable sources that are exempt from the climate change levy, or from self generation, provided this does not entail excessive cost. This will rise to at least 10% supplied from such sources by 31 March 2008, but will be reviewed after 31 March 2003, to take account of market conditions following the introduction of the renewables obligation. In 2001 all departments reported renewable energy as a proportion of energy use for the whole estate, rather than for specific buildings, as in previous reports. Nine departments currently purchase energy from renewable sources. Some already exceed the target while others have yet to procure green electricity - progress is partly dependent upon the expiry date for current contracts. A quarter of the electricity supplied to 10 Downing Street is now being sourced from renewables, including wind power and landfill gas. The Department of Social Security - the first government department to have a building with 100% renewable electricity supplies - is extending this arrangement to include 30 more offices. The electricity will be generated from wind power and landfill gas³.

A number of UK city and local authorities have made similar commitments.

- ❑ Gloucestershire County Council has successfully purchased 100% green energy for its Shire Hall complex following a competitive tendering process which included a specification for green energy supply on a varying percentage basis and an environmental questionnaire.
- ❑ The City of Plymouth Council has successfully purchased green energy through a one-year contract. The contractor offered a 20% green energy component. The City of Plymouth has committed to an environmental strategy and sees the purchase of green electricity, in combination with energy efficiency measures, as a key activity in support of the strategy.
- ❑ Bristol City Council has successfully purchased green energy for its Create centre and records office complex through competitively contracting in the above 100 kW market. The tendering process allowed for premium pricing to be considered. The supply was 100% green electricity.

Adoption of a similar policy in Hong Kong would extend the existing policy towards green procurement, currently under development within EFB.

² Renewable Energy Action Agenda May 2000

³ Greening Government Third Annual Report 2001, the Green Ministries Committee UK

In addition to public support to the incremental operating revenues required to make renewable projects viable, there may also be a benefit to public co-financing of the capital costs of early projects, depending on whether a renewable energy fund is in place and the rules attached to it. As examples:

- ❑ Partial co-financing of the capital of two pilot wind farms if these were authorised through the SCA and placed under the average net fixed asset calculations;
- ❑ Support to research and development (possibility of full funding), and demonstration (co-funding), possibly including
- ❑ Co-financing of building-integrated systems in demonstration phase (of which more below).

Option F – Building Developer Incentives

As the preceding discussion has made clear, building-integrated sources present different challenges, both in terms of connection and charging, and in terms of finding mechanisms to encourage investment in the technologies concerned. Provision of support to operating revenues is of little interest to, for example, BIPV systems that are in most circumstances highly unlikely to export power to the grid. The bulk of the expense involved in BIPV is the up-front capital costs.

The key actor to influence is the building developer – tenants in multi-occupancy buildings see little interest or benefit from BIPV installations. A variety of financial mechanisms are available, and have been used elsewhere, to encourage developers to consider incorporating renewable energy installations in their projects. These include:

- ❑ Direct public co-financing of the capital cost (e.g. a fund which supplies co-financing at, say, 30%) during a demonstration phase.
- ❑ Ensuring tax regulations are favourable towards RE investment – e.g. 100% depreciation allowances for renewable energy equipment.
- ❑ Providing concessions relating to the permissible scale or dimensions of the building where the building meets a given schedule of energy performance standards, which might include renewable energy capacity.

An interesting aspect of the local context is that government is a major building developer (both directly and indirectly), and thus in a strong position to influence the design of a significant number of buildings over a 10 year period. The Architectural Services Department has already explored the potential for including RE technologies in a number of building types.

12.5.4 Option Assessment

In evaluating the applicability of the options outlined earlier to the requirements for the generic enabling measures and the individual technologies for the strategy, issues of relevance include:

- ❑ Ease of implementation – political acceptability, practical feasibility.
- ❑ Who pays, and whether participation is non-elective or elective – can individual consumers choose to fund renewables?
- ❑ Time required for implementation – what could delay the scheme, what are the procedures and approvals?
- ❑ Administrative burden - What are the administrative costs and effort required?
- ❑ Security of success – what are the risks?
- ❑ Public finance implications – is there an on-going outlay of government funds required?
- ❑ ‘Scaleability’ – is the mechanism applicable to many projects as the penetration of renewable energy increases?
- ❑ Shelf-life – will the mechanism readily withstand the uncertainty about the future regulatory environment for electricity in Hong Kong?
- ❑ Suitability for different types of technology.

A package of financial support measures is required to address the barriers and circumstances of individual technologies. The applicability of different support measures varies by technology (*Table 12-3*) though the basic distinction is between standalone and building-integrated projects.

Whilst various measures can assist the development of specific projects in the short term, a key choice for the medium-long term development of renewable energy in Hong Kong is the mechanism for financing the renewable energy fund or account – i.e. financing the incremental costs of renewable energy purchase.

Table 12-3: Application of Financial Support & Incentive Packages to Technology Types

	Wind Turbines (non-building type)	Energy from Waste	Building integrated PV	Building integrated Fuel Cells
ANFA Calculations	✓✓✓	✓	✗	✗
Renewables levy	✓✓✓	✓✓✓	✓	✓
Green Electricity Scheme	✓✓✓	✓✓✓	✓	✓
Government guarantee	✓✓✓	✓✓✓	✓	✓
RE extension to DSM programme	✗	✗	✓✓✓	✓✓✓
Other building developer incentives	✗	✗	✓✓✓	✓✓✓

Table 12-4 outlines the attributes of the options considered against the parameters listed above. It covers non-embedded generation where the key issue is securing a price for power sold sufficient to make schemes viable. PV schemes would in general (except PV power stations) not sell power to users off-site and thus these support measures would not be appropriate. The strategy recommends support measures for PV based around support to capital costs.

Observations

Based on the analysis summarised in *Table 12-4*, it appears that the choice for long-term support measures applicable to all technologies is between

- ❑ a green electricity scheme (ideally backed by a government green procurement purchase guarantee in the short-medium term)
- ❑ a general levy on tariffs.

They are, in principle, capable of providing equivalent funding for renewable energy according to

- ❑ The scale of the levy;
- ❑ The price premium of the green electricity scheme, and the level of participation.

Both are put forward as options for consideration by the government. Determining factors in the choice, which is in some part political, include:

- ❑ The practical feasibility of a government guarantee/green power procurement policy
- ❑ The political feasibility of implementing a renewable energy levy on consumer tariffs.
- ❑ The willingness of the power companies to participate in one or the other scheme.

Table 12-4: Option Assessment

	<i>Option A: ANFA/SCA</i>	<i>Option B: Renewable Levy</i>	<i>Option D: Green Electricity Tariff</i>	<i>Option E: Government Subvention</i>
<i>Scaleability</i>	Low: Exclusion of 3 rd party developers & some technologies. Potential distortion to power company economics as scale rises.	High : limited by availability of funds/scale of levy	High : limited by availability of funds / level of and demand for tariff	Moderate: Limits imposed by scale and sustainability of public subvention
<i>Implementation</i>	Potentially simple - requires government to recognise RE capacity as allowable under ANFA + acquiescence of power company, no amendment to SCA.	New agreement with power companies required to provide for incremental cost recovery via levy on tariffs	2003 Interim Review: Side agreements to codify arrangements desirable. Unregulated form could be operated in parallel.	Could be run parallel to SCA, or configured as SCA supplementary agreement. However, approval of use of public funds on an on-going basis likely to be problematic
<i>Who pays?</i>	All electricity consumers (very marginal impact) Power company could suffer very marginal decline in profitability depending on 'packaging'	All electricity consumers. Scale of impact proportional to scale of the levy. Less than 1% would be viable in first phase.	Environment-conscious consumers who elect to pay a renewable energy tariff. Potential impact on public funds if government purchase guarantee is offered and called upon	Public funds
<i>Elective/Non-elective for Consumers</i>	Non-elective	Non-elective	Elective	No direct link to consumers
<i>Risks</i>	Cooperation of power companies.	Consumer back-lash against levy.	Uncertain and possibly limited demand (could be addressed through government guarantee)	Failure of approval/renewal of public funds.
<i>Public finance implications</i>	None - except if public funds are used for partial capital co-financing.	Incremental rise in electricity bills.	Variable - Depends on: (a) extent to which government depts elect to purchase renewable power (b) the extent to which a govt guarantee on purchase is called upon	Significant - scaled according to level of subvention.

	<i>Option A: ANFA/SCA</i>	<i>Option B: Renewable Levy</i>	<i>Option D: Green Electricity Tariff</i>	<i>Option E: Government Subvention</i>
<i>Administrative Issues</i>	Limited.	Detailed accounting for government scrutiny needed, and regulated organisation to manage distribution of funds. Certification of recognised renewable energy sources. Reference and feed-in tariffs for third party projects. Agreed LRMC.	Separate accounting and independent/government scrutiny required, plus certification of recognised renewable energy sources. Regulated model could require agreement on reference tariff.	Detailed Accounting for government scrutiny needed, and regulated organisation to manage distribution of funds. Certification of recognised renewable energy sources.
<i>Durability</i>	Uncertainty post 2008	Uncertainty post 2008	No limit	Limited by durability of support for public fund subvention
<i>Technology</i>				
<i>Wind</i>	✓	✓	✓	✓
<i>Landfill Gas</i>	✗	✓	✓	✓
<i>Incinerator with energy recovery</i>	(✓)	✓	✓	✓
<i>Compatibility with project developer type</i>				
<i>Power company</i>	✓	✓	✓	✓
<i>Independent</i>	✗	✓	✓	✓

PART D

STRATEGY FOR RENEWABLE ENERGY

13 STRATEGY AND ACTION PLAN

13.1 INTRODUCTION

This chapter sets out a strategy and action plan to support renewable energy developments and the realisation of Hong Kong's renewable energy potential.¹ The strategy provides:

- ❑ Proposals for a set of enabling measures to address supply and demand side barriers to the development of renewable energy sources;
- ❑ Proposals for a set of technology-specific actions designed to support renewable energy project development;
- ❑ Proposals for awareness raising and promotional activities to raise the profile of new and renewable energy sources and to promote learning from local and international experience in RE project development.

This strategy needs to be linked to other relevant policies, strategies and programmes in fields such as energy supply, environment, sustainability and competition. At another level, it needs to provide a clearly defined framework through which the market for individual renewable energy technologies can be developed in the unique circumstances of Hong Kong.

A framework and set of general enabling actions are set out, together with specific action plans for the four renewable energy technologies that have been studied in detail. These are not the only 'renewable' technologies that can contribute to energy supply in Hong Kong. Furthermore the focus of the study has been almost exclusively on the contribution that renewable energy technologies can make to electricity demand (they also have the potential to contribute to the demand for heat and for transport fuels).

13.1.1 Objectives

The overall objective of the renewable energy strategy is to secure the wider use of renewable and other alternative energy sources in Hong Kong. Subsidiary objectives, which will contribute to and support the achievement of this overall objective, are:

- ❑ To create a positive environment for investment in renewable energy technologies;
- ❑ To create a market in which energy from renewable sources can be sold to consumers;
- ❑ To align policies, institutional arrangements and technical standards relevant to renewable energy sources so as to promote;
- ❑ To build public understanding of, and support for, the local application of renewable energy technologies.

¹ This chapter in general refers to 'renewable' energy as a catch-all term for the technologies considered within the report. This term may be amended to 'alternative' energy, with 'renewable' applied only to a sub-set of technologies such as solar PV and wind which are genuinely renewable in character.

Support for the realisation of Hong Kong's renewable energy potential will increase the contribution that renewable energy sources make to meeting Hong Kong's energy demand. Increasing the contribution of renewable energy will support existing government policies aimed at:

- ❑ Minimising the environmental impact of energy production and promoting the efficient use and conservation of energy;
- ❑ Contributing to international efforts to reduce greenhouse gas emissions into the atmosphere;
- ❑ Reducing the number of occasions (and extent to which) Hong Kong air quality objectives are exceeded.

The measures outlined in the proposed strategy will support the objectives of the government's Waste Management Plan and green buildings initiative, and the development of the Government's 'green' procurement programme. The strategy will also demonstrate Hong Kong's commitment to its role as a model green city for Asia, and help to align the SAR's approach with that adopted by China under the 10th Five Year Plan. Finally, increasing the proportion of Hong Kong's energy needs that are met from renewable source will also increase diversity of energy supply options, so helping to reduce reliance on 'imported' energy and increase security of energy supply.

It is recognised that there has been relatively little local experience in the application of renewable energy technologies. It follows that a period of learning is required to allow experience to accumulate and policies to develop. The strategy is therefore designed to develop over phases, to accommodate such learning and to reflect the parallel development of environmental and energy policies.

There is already significant interest in and support for the new and renewable energy agenda in government, in the power utilities, in NGOs and in some segments of the corporate sector. However, the right incentives need to be in place before investment in new and renewable energy technologies can progress beyond a limited number of small-scale 'demonstration' projects. This strategy is intended to create those incentives, and to address the various barriers to progress. In particular, the strategy seeks to identify and capitalise on 'win-win' outcomes that will satisfy the key requirements of the major stakeholders.

13.1.2 The Need for a Strategy

Analysis has shown that Hong Kong has a significant renewable energy resource potential which, if captured, could make a material contribution to reducing the environmental impact of our energy supplies. At present, renewable energy contributes a negligible proportion of overall energy consumption in Hong Kong.

However, both local and international experience shows that the realisation of this potential is inhibited by a wide range of institutional, economic, legal and other barriers. Government support is needed at a variety of levels to address these barriers, and to:

- ❑ Create an enabling environment for investment in renewable energy technologies;

- ❑ Raise awareness of renewable energy among the public, the private sector, decision-making bodies and other key groups;
- ❑ Encourage local learning about the application of renewable energy technologies through the fostering of demonstration projects.

The strategy brings these measures together into an integrated package with a clear set of targets and outputs. A comprehensive programme is set out, involving government, the power companies, the private sector, NGOs, decision-making bodies and engagement with the public. All these stakeholders have important roles in the process, and without their engagement it will not succeed. Nevertheless, the onus rests with the government to take the actions that are needed to 'start the ball rolling'.

13.1.3 Scope of the Strategy

The strategy focuses on the application of new and renewable energy technologies in the Hong Kong SAR. However, it is recognised that in the future there may be further opportunities for both Hong Kong and the Mainland to benefit from cross-boundary initiatives.

The strategy comprises a set of enabling measures designed to reduce barriers to adoption of new and renewable energy technologies in general. It also incorporate a set of initiatives primarily focused on key, proven technologies - wind power, solar photovoltaic and energy recovery from waste. Measures to support the demonstration of less proven technologies, such as fuel cells, are also identified.

The scope, and the definition of 'renewable energy', is thus interpreted pragmatically to include technologies that are not necessarily 'renewable' in a strict sense (e.g. energy recovery from waste), but which do provide opportunities to offset demand for fossil fuels and thus to reduce overall emissions of local and global air pollutants. The strategy adopts no position in relation to the merits of technologies applied in support of other policy programmes, but it does identify measures to promote the use of energy available from such projects should they arise.

In application the strategy should not be a document for government only. The measures proposed will directly involve power companies, building developers, private sector suppliers, key decision-making bodies and NGOs. They also involve reaching out to the community to raise awareness and popular understanding of renewable energy and its benefits.

13.2 ENABLING MEASURES

Two issues critical to the success of the strategy are the connection of renewable energy schemes to the electricity grid, and the ability of investors in renewable schemes to earn a return on their capital by receiving a fair price for the renewable power generated. We propose a set of enabling measures to encourage investment in renewable energy technologies by:

- ❑ Increasing the transparency of rules relating to connection to the electricity grid by third parties, in terms both of the technical standards and of the direct and indirect costs of

connection;

- Providing positive incentives to the power companies to invest in renewable energy schemes and to buy renewable power from third parties.

Allowing connection to the electricity grid and creation of a market for the power generated are basic requirements. In considering these issues, the structure of the electricity supply industry and the incentives created by the existing legislation and contracts governing the industry must be recognised. The two vertically integrated power companies have entered into contracts with the government that last until 2008 (the Schemes of Control Agreements), with provision for an Interim Review in 2003. Modifications to these SCAs are only possible with the mutual consent of all parties involved, which generally only takes place in the context of such Interim Reviews. However, Chapter 12 has shown that there are useful options available that need not require changes to the SCAs.

The proposed strategy seeks to encourage positive change within the existing regulatory system and contracts. It aims to encourage participation in renewable energy projects by both the power companies and by third parties. This is achieved both through the provision of incentives within the existing framework and by promoting the acceptance of changes to that framework.

13.2.1 Getting Connected – the Standards and Cost of Grid Connection

New renewable energy projects will not necessarily be owned by the power companies themselves. For Hong Kong's resource potential to be realised, it is necessary to put in place a transparent set of rules governing the technical standards for connection of third party power sources, whether they are small-scale building-integrated PV systems, large government-promoted waste management facilities or other projects. An agreed set of principles for determining the costs of connection in different circumstances is also required. This section of the strategy defines the issues to be addressed and identifies the actions required.

Standardised procedures and costing schedule or tariff serve to simplify and speed the connection of large numbers of small RE projects, e.g. standardised photovoltaic systems. In an international context, negotiations between utilities and power producers are usually on technical matters and on the extent of the engineering needed, and in Hong Kong this situation is likely to be in relation to a few larger generation proposals only.

13.2.1.1 Principle of Third Party Connection

Agreement from the power companies on the right of third party generators to connect to the grid is a necessary pre-condition for the viability of all independent RE projects that export (or may export) power. The SCAs provide no obligation on the power companies to provide such connections, and the contractual nature of the SCA framework makes the prospect of such an obligation unlikely before the SCAs expire in 2008. It follows that, in the long-term, grid access can only be guaranteed through changes to the SCA.

In the medium-term, there is an opportunity for the power companies to demonstrate their good faith by accepting grid access by independent renewable energy generators. CLP have already stated that they are willing to consider allowing grid connections of active sources,

providing their technical, legal and commercial position is safeguarded. It is presumed that HEC will take a similar position. Indeed, the government may consider that demonstrating flexibility at this stage (up to 2008) will strengthen the power companies' negotiating position when the existing SCAs expire.

13.2.1.2 *Connection Standards*

A schedule of agreed technical standards for connection to the grid is needed to:

- ❑ Safeguard the position of the power companies, which have an obligation to maintain the quality of power supplied;
- ❑ Provide transparency to third part renewable energy generators seeking to connect to the electricity grid.

It is understood² that CLP is in the process of developing guidelines in association with the ESB for the technical criteria and arrangements that will make grid connection technically acceptable.³

International experience suggests that the detailed technical requirements for the connection of larger capacity generation (say, greater than 5MW) are likely to be stringent. In practice, the requirements for smaller but significant generation (say, above 100kW) will be little different. Appendix 1 provides a schedule of the detailed technical specifications that are to be expected for the connection of larger scale generation. Whilst these requirements may appear complex, they are entirely appropriate for larger generation capacities, because of the issues of safety and grid system operation and protection involved. It would be surprising if similar requirements did not emerge from the CLP/HEC/ESB consultations.

RE project developers and grid owners would typically treat each generation connection as an individual design project. Some aspects of the protection arrangements and settings inevitably need to be site specific, and some of the technical parameters involved (such as fault level limits) are also site specific. It is also important to note that there are numerous examples of such connections having been made to 132 kV, 33 kV and 11 kV systems.

For small, active sources such as building integrated photovoltaic systems, international experience shows that technical requirements can be simplified and that they are unlikely to be site-specific. As an extreme example, the Netherlands allows photovoltaic sources with less than 400W output to be operated in parallel with the grid on a "plug in" basis.⁴ However,

² From statements by CLP at the Stakeholder Seminar 17 July 2001, and from subsequent meetings with EFB 19th July 2001. Note: The consultants believe that the connection at SENT landfill should not be interpreted as a signal that these issues can be left for the market to address.

³ It is reasonable for the grid operator to protect its assets from damage caused by activities of anyone using the service,

1. to ensure that any system connected to the distribution system will not cause quality of supply problems to others, or
2. take reasonable measures to ensure that safe operation occurs – and that employees, property and public are protected from damage. To achieve these ends, grid operators usually work to standards concerning (amongst other things): harmonic penetration, limitation of fault level contribution from generation onto the system; voltage control, protection arrangements and quality and reliability (especially concerning feed into the grid), and intertripping arrangements.

⁴ Discussion with EKOMATION Netherlands July 2001.

the grid operators treat all low voltage systems as “live” under all conditions, and the photovoltaic systems and associated electrical equipment have to be ‘type approved’. In particular, they must be designed to be ‘fail safe’ (for example, in the event of an internal short circuit) and to shut down automatically if the grid itself fails (in order not to represent a safety risk to those working to restore the grid). In practice, these standards are not difficult or costly to achieve.

There are also guidelines elsewhere for streamlined processes for the connection of larger systems connected to the lower voltage systems. For example, there are trials of grid connection procedures that include equipment approval schemes for small photovoltaic systems.⁵ These processes facilitate the connection of up to 5kW of PV sources at a location, ostensibly without any detailed requirement to comply with grid connection standards. There is still usually a process of notification and approval from the utility involved, but the process is streamlined. *Appendix C* gives further details of technical schemes for smaller grid connected active sources from a typical UK utility.

There are also issues to be addressed in relation to the quality of the electricity supply as well as safety issues. *Appendices B and C* indicate the additional technical requirements that need to be met in relation to harmonics and grid disturbance. International experience indicates that in most cases PV and fuel cell systems, whilst risking the production of harmonics, can be designed to match most grid operator standards. These standards already exist for the control of flicker and harmonics from solid-state controls of lighting, motors and transmitters etc.

These international examples mirror issues that have arisen in Hong Kong, and indicate that it is possible to overcome such concerns. In practice, such requirements are often found to be burdensome with respect to the installation requirements (isolation switches and access in particular), but the type-approval route offers a streamlined means of compliance with most of the technical requirements for grid connection.

Whilst these standards are complex, it is possible that type-approval processes for specific products and streamlined approval procedures for individual installations could be introduced.

Options Summary

In this context, we propose that the government may:

- ❑ Take steps to ensure that CLP and HEC are not disadvantaged technically, legally or commercially if they do allow third party access or participate directly in RE projects;
- ❑ Ensure that technical and safety standards for grid connection are developed in collaboration with all relevant stakeholders, ensuring that all standards are appropriate for the scale of generation envisaged;
- ❑ Encourage CLP and HEC to allow access to the grid by third-party developers of renewable energy projects;

⁵ For Example UK Standard G77 is currently under trial for units less than 5kVA.

- ❑ Encourage CLP and HEC to participate (as developers) in relevant renewable energy projects;
- ❑ Monitor (as regulator) the operation of technical standards and connection agreements between independent generators and the power companies to ensure that no significant institutional/technical barriers remain;
- ❑ Establish the 'type approval' of BIPV products that could be connected under the revised technical standards.

For the purposes of the strategy phases, these are all near-term measures to be pursued as soon as possible.

13.2.1.3 *Connection Charges*

Connection costs and timing for larger generation can be a significant component of the scheme costs and a source of uncertainty in establishing the timing and "bankability" of RE projects. In Hong Kong there is at present no set process or agreed principles by which the fair costs of connection for third party grid connection are determined. Local RE developers appear to anticipate that connections costs and their implementation will, inevitably, be too high and take a long time to secure.⁶ This perception does little to encourage RE development, and any moves that can be taken to change the situation (or developers' perceptions of it) are to be welcomed.

International experience supports the direction of conclusions from local experience; i.e. that without government/regulator intervention in such cases, there is scope for undue exercise of market power by the incumbent grid operating company, which in the case of Hong Kong is also the incumbent generator. If small, independent renewable energy producers are not to face the risk of excess charges, a transparent set of rules on this key issue are important on competition grounds.

In Hong Kong the regulatory regime does not explicitly cover connection charges. It is suggested that full transparency in charging should be encouraged. This recommendation is in line with international practice. For larger generation, this should cover:

- ❑ the design process and related standards;
- ❑ the availability of data for independent scrutiny;
- ❑ definition of a reasonable quotation programme.

For small active sources, a simplified approach to connection costing should be established.

The calculation of connection charges for renewable customers cannot be separated from the policy of setting tariffs, and therefore unless the tariff policy for support to network costs is

⁶ It is reported anecdotally that electrical utility connection charges are prohibitive, although specific examples have not been established by consultants' discussions with potential developers. It is important to clarify this situation. It is recommended that the government reviews this situation, surveying RE developers for their experience and to assess the situation with regard to costs.

clear, it is not possible to provide an exhaustive listing of factors to be considered. However, key aspects are:

- ❑ what capital and O&M costs are supported by the normal tariffs for connection;
- ❑ the capital and O&M costs of normal connection for each class of connectee;
- ❑ if deep connection costs are to be included;
- ❑ if the generation export is significant compared with site demand, whether any standard connection charge should be considered and if a special site-specific costing should be considered.

It is important to ensure that RE developers are fully informed of the issues and costs. With respect to larger output plant (say >0.5MW), there may be a need to clarify the connection options with respect to reliability. For example, a single leg connection, even at 132kV may be judged appropriate because renewable energy sources such as landfill gas generation or wind power are essentially energy exporters, rather than guaranteed power providers. In addition it is important to establish a transparent policy on whether “deep” reinforcement costs will be charged to new connections.

Apart from the initial costs of complying with general technical requirements, it is expected that developers of RE projects in Hong Kong would be expected to contribute to the costs of connection to the grid. Here it is useful to differentiate between the extremes:

- ❑ Sites where virtually all generation is to be exported to the grid (e.g. wind-farms); and
- ❑ Sites where all the output of the active sources are absorbed within the site (e.g. BIPV and perhaps BIFC projects).

The promotion of schemes that export large quantities of power can encounter technical design difficulties because of a lack of information that the developer can use to make judgements as to the fairness of connection costs quoted by grid operators and difficulties in accessing technical requirements/standards of the grid operators – planning (electrical system planning) and technical design issues arise. Typical problems are stringent fault level constraints and connection point selection, both of which are in the remit of the utilities/grid owners. Internationally, it is not uncommon to find that some transparency of information is prescribed in Codes of Practice that are approved by utility regulators.

Options Summary

It is proposed that the government should:

- ❑ Encourage the fullest transparency with regard to the process and principles of charging. For larger generation, this should cover design process and standards, availability of data for independent scrutiny and definition of a reasonable quotation programme, commitment programme management etc. For small active sources, it may well establish a simplified approach to connection costing. Encourage grid operators to publish guidance on the processes involved and require specific speed or responses to developers so that undue delay is avoided;

- ❑ Ensure that information on the charging principles and their basis is disseminated to RE developers through awareness-raising activities such as seminars.

These measures can be initiated in the initial phase of the strategy, but will be ongoing in their application.

13.2.2 Creating a Market for Renewable Energy

The success of the strategy requires the creation of new financial incentives that encourage both the power companies and third party RE project developers to enter and participate in the market for renewable energy in Hong Kong. However, as already noted, it is important that the power companies are not technically, legally or commercially disadvantaged if they accept (RE) power from independent generators or invest in renewable energy projects themselves.

Even if the power companies do allow third party generators to connect to the grid, there is still no mechanism for selling that power. Independent RE projects cannot sell power either to the power company or to electricity consumers directly. Furthermore, there is no mechanism for the power companies to re-sell renewable power at a price sufficient to cover the purchase cost and an operating margin even if they did purchase it from the third party.

There is at present no obligation on the power companies to purchase third party power. They have been directed towards investment in cost-effective conventional power sources that provides electricity at 'lowest reasonable cost'. Generation capacity approved under the Schemes of Control Agreements has not so far included renewable schemes, so they have not invested in such schemes themselves either.

Electricity from renewable sources will displace power from existing conventional generating capacity, and will often be more expensive on a \$/kWh basis than this conventional power. There is no agreed mechanism by which the additional costs of renewable energy can be recovered from consumers, even if the power companies were to develop projects themselves. Depending on the scale and timing of new RE projects, there is also a potential impact on the utilisation of existing, conventional (or nuclear) generation capacity, or of additional programmed investments in new conventional capacity. However, the scale of generation capacity provided by the renewable energy projects contemplated in the next ten years (between now and 2012) is very small in relation to the overall installed generation capacity in Hong Kong, and is within the margin of error of the forecasts. We do not see the objectives set out for the period, which is an initial technology demonstration phase, having a material impact on the programming of investment in conventional generation capacity.

A range of new financial instruments is available to stimulate participation of the power companies in the renewable energy market, and provide an intermediary market for third party renewable energy producers. Options include:

- ❑ Agreement with the government that the capital and operating costs of renewable energy projects developed, owned and operated by the power companies will be included in their allowed fixed asset base for the purposes of calculation of general tariffs. This would not, in principle, require modification of the Scheme of Control Agreements. It would however involve the government interpreting this new power

capacity as being consistent with the SCA's terms on supply at lowest reasonable cost.

- ❑ Establishing a renewable energy fund or account to purchase renewable energy at an agreed margin over a specified baseload marginal cost of power, the fund being topped up from a general levy on electricity tariffs.
- ❑ Introduction of a voluntary Green Electricity Scheme, under which consumers (corporate, government or household) could elect to contract with their power supplier to purchase electricity from certified renewable sources. The tariff rate under the Green Electricity Scheme would be higher than the regular tariff, and either set freely by the power company or defined on the basis of a formula agreed with government. It appears that this could be operated in parallel to the Schemes of Control Agreements without amendment to them, or could be established in a side agreement to the SCAs. Revenues would feed a renewable energy fund or account to support operating revenues (and capital co-financing if appropriate) as under the alternative levy arrangement.
- ❑ If uncertainty of demand was a barrier to implementation, or for the early phase, the implementation of this approach could be assisted through the underwriting of the Green Electricity Scheme by a Government purchase guarantee, through which Government undertook to buy power from certified renewable sources within specified price limits (set for each relevant technology). Government's own electricity demand is more than sufficient to absorb power from all RE projects that could conceivably be developed in the next 10 years.

Additional measures are available to support embedded generation (e.g. BIPV). These are discussed in later sections.

The selection of a preferred renewable energy financing mechanism (the attributes of each option are discussed in the preceding chapter) needs to be completed as soon as possible, such that negotiations on the pricing and implementation issues can take place.

Options Summary

Provision of a mechanism for power companies and project promoters to achieve a reasonable return on RE investment is a fundamental component of the enabling environment for promoting RE development. Key steps are:

- ❑ Selection of a preferred financial mechanism, or combination of mechanisms
- ❑ Initiation of a price review in order to determine a reference tariff and appropriate 'top-up' tariffs for individual renewable technologies (if/where required)
- ❑ Determine whether a government green power procurement policy is feasible

Once a preferred financial strategy has been determined, appropriate preparation would be required for the implementation. New accounting systems will be required, and ancillary systems such as a process for certifying renewable energy sources.

13.3 TECHNOLOGY-SPECIFIC ACTIONS

This section presents options for technology-specific actions to promote renewable energy development.

13.3.1 Wind Energy

Resolution of the issues relating to grid connection by third party suppliers and the establishment of tariffs for the sale of electricity is crucial to the development of wind power in Hong Kong. This is also a field in which the power utilities themselves may have a direct interest, providing their commercial position is protected. The enabling measures that are needed to address these issues have been identified in Section 13.2. However, the timetable for the implementation of those enabling measures will clearly have an impact on the rate at which the wind power market in Hong Kong develops.

The enabling measures alone are necessary but not sufficient to secure the establishment of a viable wind energy market in Hong Kong. Other barriers to development of wind energy include:

- ❑ The perceived high level of risk, resulting from the fact that there are at present no commercial-scale wind energy projects in Hong Kong;
- ❑ The relatively poor rate of return likely to be provided by wind energy projects, resulting in part from low (likely) electricity purchase tariffs and from the relatively high cost of early 'one off' projects that cannot benefit from economies of scale;
- ❑ The limited number of sites suitable for wind turbine projects that have been identified so far, together with lack of awareness of those sites and their characteristics;
- ❑ The lack of familiarity of the population at large and those responsible for the planning system with the issues raised by wind energy; and
- ❑ Lack of an experienced 'supply side' capable of implementing large-scale wind energy projects in Hong Kong.

Options for the Government in addressing those barriers are:

- ❑ Supporting the development of large-scale onshore and offshore wind power demonstration projects, in collaboration either with the energy utilities (CLP and HEC) or with major international project developers in this field;
- ❑ Providing the initial financial incentives that are needed to make wind energy a more attractive investment, probably through the provision of favourable tariffs for wind energy projects;
- ❑ Providing support for the identification and characterisation of potential sites for onshore and offshore wind energy projects;
- ❑ Developing and promulgating clear guidance on the technical, environmental and planning criteria to be met by wind energy projects, including advice for project

developers.

It is suggested that Hong Kong should first seek to establish two commercial scale wind energy demonstration projects. In theory, this could allow one project to be brought forward by each utility, each involving one or (preferably) a small 'cluster' of turbines. This is likely to be the fastest option for progress, although (given the long lead times associated with projects of this nature) the earliest a demonstration project of this nature could be operating is probably 2010. Alternatively, the government may wish to tender the opportunity to develop a project through open competition.

A site-identification, screening and characterisation exercise will be required, but this should be broader than the potential demonstration projects. It will need not only to identify potentially suitable sites, but also to identify any site-specific barriers (technical, legal, institutional or commercial) to project implementation and how (if at all) they might be addressed. It is also necessary to monitor the wind resource at the most promising potential sites in order to help potential developers to assess their economic viability. Many of the site-specific issues will relate to planning, and these need to be incorporated in guidance for developers. Ideally, it may be possible to identify and designate (in planning terms) sites that are potentially suitable for wind energy projects and where such developments would be approved providing they met all relevant technical and environmental criteria.

There are various options by which these projects (and any further investments in wind energy) may be financed. These depend on factors such as whether or not the project developer is one of the power companies, since this opens the way to incorporation of the project within the company's fixed asset base for the purposes of tariff calculations. More general mechanisms include the levy-based system and the possibility of a green tariff scheme.

The package of options for further development of wind energy technologies in Hong Kong is described below.

Options Summary

It is suggested that the following options are examined:

- ❑ The government seek to facilitate involvement of the power companies in wind energy projects;
- ❑ Examine whether it is necessary to stimulate the pilot wind energy projects by providing a contribution to the capital cost of at least two such demonstration schemes;
- ❑ Commission a study to identify possible sites for wind energy development within the territory of the Hong Kong SAR (i.e. land and marine) on the basis of an agreed site selection criteria, and to evaluate the more promising sites in greater detail;
- ❑ Develop and promulgate planning policy and guidance as it relates to wind turbine installations in the Hong Kong SAR;
- ❑ Provide stakeholders in the land use planning system with information and guidance about the benefits of wind energy, and international experience in relation to the

environmental, socio-economic and visual impacts of wind farm development.

The 'median case' scenario for the market penetration of wind energy in Hong Kong is based on the following assumptions:

	ONSHORE	OFFSHORE
Average turbine size	0.7MW	1.25MW
Number of turbines in 'cluster' (typical project)	2	2
Capacity factor	25%	35%
Annual output per MW installed	2.19 GWh/MW	3.06 GWh/MW
Pilot projects operating	2006	2007
Further investment/replication starts	2012	2013

On this basis, the rate of market penetration is indicated in *Table 13-1*. This indicates that wind energy will make no contribution at all in the short-term and only 13.8 GWh/yr by 2012. However, in the longer term the contribution of wind power increases rapidly to reach 127 GWh/yr by 2017 and 361 GWh/yr by 2022. Roughly two thirds of these totals are assumed to come from near/offshore wind turbines and only one third from onshore projects.

Table 13-1: Market Penetration of Wind Power (GWh/yr)

Year	Onshore	Offshore	Total
2012	6	7	14
2017	43	84	127
2022	116	245	361

There is clearly considerable uncertainty associated with rate at which schemes will in practice be brought forward, and thus uncertainty attached to these figures. Nevertheless, they are regarded as relatively conservative for a regime in which RE projects would be actively encouraged. In practice, these levels of output require 142-turbine onshore 'clusters' and 11 offshore 'clusters' to be built over the next 15 years (to 2017). They reflect the slow initial build-up and more rapid growth over the final five years (2012 to 2017) that have been experienced in other countries.

A more optimistic scenario (see *Table 13-2*) indicates a contribution of 107 GWh/yr by 2012 and 803 GWh/yr by 2017, with offshore accounting for around 60% of the total. A more pessimistic 'business as usual' scenario delays implementation with only 3.5 GWh/yr by 2012 and 15 GWh/yr by 2017 (70% offshore).

The 127 GWh of wind power projected for 2017 under the central scenario represents 0.36% of Hong Kong's 1999 electricity consumption.⁷ The 361 GWh projected for 2022 represents 1.02% of 1999 consumption.

Table 13-2: Energy Output from Wind Projects under Alternative Scenarios

	2012	2017	2022
Median	13.8	127	361
Pessimistic	3.5	15	56
Optimistic	107	803	1730

⁷ This and the later % calculations are based on 1999 consumption of 35,500 GWh.

As there are still many unresolved technical issues related to rooftop wind turbines, urban wind schemes have therefore not been considered further in this analysis, though the mechanisms discussed for building-integrated (embedded) systems could in principle apply to wind turbines if the safety and other concerns were overcome.

13.3.2 Energy from Waste

The Government is pursuing integrated bulk waste treatment facilities to ensure that Hong Kong's various waste streams that cannot be reused or recycled are properly treated and disposed of in accordance with the Waste Management Plan. This provides various opportunities for the recovery of energy embodied in these wastes. Although not strictly 'renewable', these energy sources do provide opportunities to capture and use energy that would otherwise be lost, and thereby substitute for power generated from fossil fuel combustion.

Actions are proposed in relation to two specific opportunities – landfill gas utilisation and thermal treatment with energy recovery. Other opportunities relating to the composting and anaerobic digestion of wastes (municipal wastes, sewage sludge, animal wastes) are not considered at this stage.

The mix of energy schemes adopted is largely a matter for Hong Kong's waste management strategy. Both may have a part to play in that strategy, and both give rise to opportunities for energy recovery. The degree of energy recovery possible from a tonne of waste through thermal treatment is greater than that achieved from landfill gas, but very large volumes of LFG will be produced from Hong Kong's landfills under any of the waste management strategy scenarios currently under consideration – from waste deposited and that which must be deposited in landfills in the years to come.

The primary driver of the waste management programme is a desire to reduce the bulk of waste arisings. These investments would therefore be triggered by policy objectives other than energy supply, but would provide opportunities for energy recovery. There are however significant environmental concerns about some thermal technologies such as incineration within the community. These need to be addressed before schemes are brought forward.

13.3.2.1 Landfill Gas

Landfills form an important component of Hong Kong's waste management strategy, particularly for municipal solid waste from households and commerce. The decomposition of the organic components of this waste releases landfill gas, which contains methane and can be used as a fuel.

Landfill gas can be used directly as a fuel or converted to electricity and used to meet site power demands or supplied to the grid. The technology for power generation from landfill gas is well proven, and has already been employed to meet on-site energy needs at several landfills in Hong Kong. One such scheme is already exporting electricity to the grid as well as meeting site demands.

Landfill gas from Hong Kong's three strategic landfills is collected, and some of the gas is used to generate electricity to meet on-site demands. In the absence of an off-site market for

any additional power, the gas not used for on-site generation is simply flared off. It should be noted that, while the flaring of landfill gas clearly produces CO₂ and therefore contributes to Hong Kong's greenhouse gas emissions, in fact landfill gas is a far more powerful greenhouse gas than CO₂. It is therefore beneficial (from this perspective) to flare the landfill gas rather than letting it escape to the atmosphere.

The enabling measures discussed at Section 13.2 above provide the basis for making better use of the landfill gas resource. With grid access and a market for the electricity produced, the present barriers to power export should largely drop away. The technology is well-proven, and in many applications cost-effective at 'normal' tariff rates.

If these measures can be introduced, landfill operators should be given full encouragement to convert gas to electricity and sell power that is surplus to on-site requirements to the grid. The government should also consider waiving any royalty payments currently applied to the profits stemming from this activity in order to further encourage the use of landfill gas for power generation. Landfill operators would need to be informed about the opportunities existing in this field and the economic implications of the changes noted above.

On present waste management planning assumptions, annual landfill gas production will reach 303 million m³ in 2005, falling to about 30 million m³ in 2040 as more waste is disposed of by thermal treatment (see below). However, this clearly depends on identifying suitable sites and overcoming local objections to the development of the waste treatment facilities.

We have therefore identified one scenario as based on the continued use of landfill as the only disposal route for municipal waste. In practice, gas output from the WENT and NENT sites is projected to peak around 2020 and thereafter decline. Output from SENT is expected to decline rapidly after 2005, so new disposal sites (or extensions to existing ones) will need to be established. The 'landfill only' scenario for the market penetration of energy-from-waste in Hong Kong is based on the following assumptions:

	<u>LANDFILL</u>
Current municipal waste to landfill (2000)	4.75 Mte/yr
Current landfill gas production (2000)	282.9 Mm ³ /yr
Annual growth in waste arisings/ gas production	1.4%
Proportion of landfill gas recovered for power generation	40%
Efficiency of power generation from landfill gas	1.80 GWh/Mm ³

On this basis, landfill gas has the potential to contribute around 250 GWh/yr by 2017 and 270 GWh/yr by 2022 (*Table 13-3*), equivalent to 0.70% and 0.76% of 1999 electricity consumption respectively. These longer-term contribution levels can probably be achieved in practice, but in the shorter term the likely contribution of landfill gas to the grid is likely to be significantly less than its potential contribution. This reflects the fact that measures need to be put in place to allow landfill gas projects to contribute to the grid (and receive payment for exported power) before large scale investment in 'exporting' projects starts to take place.

Table 13-3: Contribution of Energy from Waste (Landfill Gas Scenario)

Year	Potential Contribution (GWh/yr)	Likely Contribution (GWh/yr)
2012	231	231
2017	254	254
2022	273	273

Thus, under the 'landfill only' scenario landfill gas has the potential to contribute perhaps 0.7% of Hong Kong's current annual energy demand. There is clearly a natural limit to the contribution from this source, even if landfill remains the sole disposal route. Although the waste in a landfill site typically generates gas for around 20 years, once existing sites have been 'mined' to collect the gas a 'steady state' is reached where 'new' waste being landfilled is balanced by 'old' waste that no longer produces gas. Once this situation has been reached, the increase in gas production reflects only the increase in the volume of (biodegradable) waste being landfilled.

13.3.2.2 Thermal Treatment with Energy Recovery

Assuming the Government adopts thermal treatment as a suitable bulk waste reduction technology, and provided that all statutory requirements are satisfied, this technology could be applied to waste streams such as sewage sludge and municipal solid waste. The potential net power output of a MSW thermal treatment facility with energy recovery is significant – 52.4MW for a 3000 tonne per day facility. This is the largest of the non-fossil fuel power sources in prospect in Hong Kong in the next 10 to 20 years.

In liberalised markets, the sale of power generated at an MSW treatment facility would typically provide around 30% of the project's revenue. The absence of a market for such power in Hong Kong thus has an impact on the financial viability of the schemes under consideration. In Hong Kong such projects are typically let by Government to a private contractor for a specified period under a design-build-operate-transfer agreement in which the Contract specifies a schedule of capital and operating fees. Without a market for the power, it can be expected that the price to Government of the facility will increase to reflect the revenue shortfall. Providing a market should therefore increase the exploitation of a RE resource, whilst also reducing the social cost of the project.

On current programming, one integrated MSW treatment facility is assumed to be operating around 2012. If thermal treatment is adopted with energy recovery, a net power output of 52.4 MW is expected. This is assumed to generate 460 GWh in 2012. Assuming a second such facility is operational by 2014,⁸ the total contribution would increase to 920 GWh. Additionally, a sewage sludge treatment facility with energy recovery, with an annual electricity export of 12 GWh is assumed to be operational from 2012.

A challenge to the consideration of exploitation of power from these facilities is that none of the facilities are expected to be commissioned before 2009, i.e. beyond the end of the current Scheme of Control Agreements. In order to advance these projects efficiently, some agreement on power purchase will be required before 2009. An option is for the government to provide a power purchase guarantee for these projects, such that the project proponent is assured of a given tariff rate for power exported from the site. Addressing this project risk should enable those tendering for the DBOT contracts to price their offers more

⁸ Assuming the project proceeds according to the programme assumed in EPD's investigations.

competitively, and thus reduce the tender price of the waste facilities – which are themselves government projects. There are therefore potentially multiple benefits to be obtained in that:

- ❑ power generated is used productively;
- ❑ the waste facilities can be offered to government at a more competitive price.

Negotiations would be required with the relevant power company to determine a fair rate of compensation for wheeling the power from the energy-from-waste facility.

If a government guarantee is not feasible, the alternative is certification of the thermal waste treatment facility as a renewable resource for the purposes of the standard renewable energy levy or green electricity scheme. However, there may be community objections to waste-derived electricity being considered as ‘green’.

The move from landfill disposal towards thermal treatment with energy recovery will clearly reduce the landfill gas available for power generation. However, this effect is likely to be modest over the period covered for three reasons:

- ❑ there will be no ‘transfer’ until the first waste treatment plant opens in 2012;
- ❑ waste in the landfill sites continues to generate gas for perhaps 20 years;
- ❑ the landfill sites must also accommodate the projected increase in waste arisings.

There is therefore an ‘Thermal Treatment Scenario’, based on the introduction of integrated MSW treatment facilities utilising thermal technology coupled with energy recovery in 2012 and 2014 and a modest decline in landfill gas production (*Table 13-4*). This clearly demonstrates the enhanced contribution of MSW thermal treatment to overall output from EFW, which would rise to 656 GWh/yr in 2012 and 679 GWh in 2017. It follows that the actual contribution of EFW is critically dependent on the timing of new waste treatment facilities coming ‘on stream’.

While in the short-term and medium-term the two scenarios are identical, the Thermal Treatment Scenario provides a much greater contribution to the grid in the longer term. Again it must be emphasised that both contributions are naturally ‘bounded’ by the volume of waste (MSW) available, although increasing the number of treatment facilities (beyond the two envisaged) would further increase the overall EFW contribution. It follows that these two scenarios are both relatively conservative, since the potential for further increase does in fact exist. However, the decision between the two scenarios is a waste management strategy issue rather than an energy issue.

Table 13-4: Contribution of Energy from Waste (Thermal Treatment Scenario)

Year	Landfill Gas Contribution (GWh/yr)	Sludge Treatment Contribution (GWh/yr)	MSW Treatment Contribution (GWh/yr)	Total EfW Contribution (GWh/yr)
2012	184	12	472	656
2017	161	12	932	1,092
2022	179	12	932	1,111

The thermal treatment capacity provides electricity equivalent to 1.33% of 1999 local consumption in 2012 and 2.62% in 2017.

13.3.2.3 Options Summary

Recommended options for development of Hong Kong's landfill gas resources are as follows:

- ❑ Implement the enabling actions for grid connection and power purchase
- ❑ Review prices offered by landfill gas projects to determine if they exceed the reference tariffs, if so, set 'top-up' tariffs supported by the renewable energy fund (if adopted).
- ❑ Consider waiving the profit royalty in the landfill operation contracts for revenues relating to sale of landfill gas and derived products.
- ❑ Liaise with landfill operators and landfill rehabilitation contractors to ensure the new rules and opportunities are understood.
- ❑ Develop an initial (large scale) export LFG installation as a demonstration project, not to demonstrate the technology but rather the economic and institutional issues and how they were addressed.

Recommended options identified for providing a market for electricity from integrated waste management treatment facilities utilising thermal treatment with energy recovery, building on the enabling measures identified previously are:

- ❑ For government to consider a power purchase guarantee for power generated from such projects. Negotiations would be required with the power companies on this issue.
- ❑ For integrated waste treatment facilities with energy recovery to be considered large exporters for the purposes of grid connection, and the technical standards for connection need to be comprehensive.
- ❑ Requirement for energy recovery and utilisation to be incorporated in DBOT tender agreements, subject to resolution of access and tariff issues.

These are predicated on the assumption that the enabling measures for grid connection outlined in 13.2 are implemented.

13.3.3 Building-integrated Renewable Energy Sources

Hong Kong has a highly urbanised environment. Buildings account for the largest fraction of our electricity consumption. Building-embedded generation such as solar photovoltaic panels, building integrated fuel cells, building-mounted wind and small-scale cogeneration have the potential to reduce a building's net energy demand. Such embedded generation can also reduce peak electrical loads, and provides savings in distribution costs to the power company. In some circumstances, embedded generation can even eliminate the need to invest in reinforcing the local electricity supply network to meet increasing demand. A set of actions is proposed to support the development of building-integrated new and renewable

energy technologies. These focus primarily on solar photovoltaics, but may be adapted to support fuel cell technologies and urban wind turbine technologies as they mature.

The major barriers to further adoption of BIPV systems are:

- ❑ Lack of transparent rules for the connection of PV systems to a building's electricity supply;
- ❑ The absence of incentives for developers of multi-user buildings or the power companies that supply them to make use of BIPV systems (the developer making the investment would not benefit from the net savings achieved);
- ❑ The comparatively long payback period of typical BIPV installations;
- ❑ The relative unfamiliarity of building professionals and the construction sector with photovoltaic technologies, together with their inherent technical conservatism.

Whereas some technologies (for example, landfill gas to energy) are already economically competitive with conventional power sources, solar PV remains a relatively expensive source of renewable electricity. Project payback periods are typically in the range 10-20 years, which is beyond the threshold of interest for commercial investors. Nevertheless, PV power is already considerably cheaper than it was 10 years ago, and expectations are that costs will fall further over the next 10 years and performance will increase. The application of BIPV technology in a high-rise built environment and a sub-tropical climate such as Hong Kong remains relatively untested, although a number of small scale projects have already been implemented in universities and in government buildings.

The export (to the grid) of power from building-integrated PV schemes on large, tall buildings will be extremely rare, since such PV systems are unlikely to meet more than a few percentage points of the total building electricity demand. Even in periods of low internal demand, PV power can be used to support central services and cooling. It follows that the export of power is less of an issue here than for the other, more large-scale technologies that have been considered.

The analysis above indicates that there are both technical and commercial issues to be addressed before small-scale, building-integrated technologies can make a realistic contribution to electricity supply in Hong Kong. From a technical perspective, it is necessary to create a framework within which these small-scale generators can contribute directly to meeting the electrical loads of the building on which they are located. This is broadly independent of the technology involved.

Recommended options for addressing these technical barriers are:

- ❑ Definition of technical and safety standards for connection of 'small scale' generation into a building's electrical systems;
- ❑ Certification/accreditation of individual products and/or suppliers/installers.

The commercial issues are different for different technologies and so are considered separately. However, we believe that a common requirement is the need for a

demonstration programme to support the initial deployment of the technologies that will contribute to embedded generation. Hong Kong provides a demanding urban environment in which to apply renewable energy technologies, albeit one which perhaps is indicative of the urban form of many cities in east and south-east Asia. The proposed Building-Integrated Renewable Energy Demonstration Programme would be designed to:

- ❑ Prove the technologies in all major building types in Hong Kong;
- ❑ Provide learning opportunities for those involved in BIPV and BIFC development; and
- ❑ Help foster the creation of a local BIPV supply industry in expectation of the costs of the technology falling considering over the coming 10 years.

The essential features of this programme are:

- ❑ Support for capital investment in the relevant technologies, not to make them cost-effective but rather to offset risk and to 'buy access' to the information generated;
- ❑ Independent monitoring of all project, covering not only their technical and economic performance but also the experience gained in implementing the project; and
- ❑ Promotion of the performance information to other potential users of the same technology, both directly (case studies, site visits etc) and indirectly (for example, by using the information gained to prepare project implementation guides.

Other aspects of the programme will be specific to individual technologies.

13.3.3.1 Building-Integrated Photovoltaic Systems (BIPV)

For significant progress to be made with installation of BIPV in Hong Kong it is considered that a programme of BIPV demonstration projects will be required. While this would be intended to cover a wide range of building types found in Hong Kong, it would initially be focused on government owned and occupied buildings since this is clearly the easiest sector for the government itself to address. The second priority would be other (industrial and commercial) 'owner occupiers'.

It is important to distinguish between the peak output of a BIPV installation (kWp) and the output that will actually be achieved over a period. Clearly on average a system will only operate at a small fraction of its peak output (for example, at night the output will be zero). Clearly the annual output from the system is most relevant, and the technical study indicates that we may assume an annual output of 0.12 MWh/m² of PV collector. We have also assumed that a typical PV installation would have an effective area of 750 m², giving an average annual output of 90 MWh (0.09 GWh).

A meaningful BIPV demonstration programme would involve perhaps 80 different projects. This number may seem large, but it is small compared to the size of the government-supported PV programmes in the USA, Japan, Germany and several other European countries, which all cover a thousand or more installations. This scale of demonstration programme is required to:

- ❑ Demonstrate a serious commitment by the HK government to renewable energy in general and BIPV in particular;
- ❑ Cover a range of different technical applications (building types and BIPV systems);
- ❑ Cover a range of building owners (public, private etc.); and
- ❑ Encourage the establishment of a viable 'supply side' to service the HK BIPV market.

A programme of 80 installations would have a total output of around 7.2 GWh/yr. The key question is over what period such a programme could be established. This depends in turn on how long it takes to address the technical and institutional barriers that have been identified, and on the level of support (funding) available for the individual demonstration projects.

The options identified for implementing and financing the scheme are as follows:

- ❑ Adoption of an organisation and financing model of the kind previously demonstrated in the Demand Side Management programme, to include BIPV installations, such that the power companies would invest in PV systems in existing commercial buildings and recover the cost through a levy on electricity tariffs;
- ❑ Inclusion of PV installations in a cross-section of new government buildings designed by Architectural Services Department (with the cost met directly by government) and, where possible, inclusion in buildings where government is in a position to influence design or funding;
- ❑ A direct grant programme for building developers through which up to 50% of the capital cost of the BIPV installation would be available to the developers of suitable projects on application to EMSD;
- ❑ BIPV installations could also be categorised as 'manufacturing equipment' by the Inland Revenue Department for the purposes of Hong Kong's general rules of accounting, so that 100% depreciation allowances are available.

These options are not mutually exclusive and could be applied in combination to address new and existing commercial buildings, and to government buildings. In the future, once the performance of PV systems in different kinds of high rise building in Hong Kong is better understood, incentives of the kind developed by Building Department under the Green Building Programme could be deployed to encourage the incorporation of BIPV.

The additional cost to the renewable energy fund of the proposed BIPV programme is a function of the factors such as the level (%) of co-financing terms available to building developers, the size of schemes that developers put forward for financing under the scheme, and the extent to which projects can be undertaken in government buildings and incorporated into the costs of providing these projects.

It is also important that the programme include a monitoring and evaluation component so that experience gained from these projects is shared. This sharing of information should be a condition of the direct grant programme. It is also desirable for all schemes to incorporate

an in-building information and demonstration component – such as an information board with meter.

It is unrealistic to expect significant market penetration of BIPV within the next few years. Once the initial barriers have been addressed, active government support as indicated above (and based initially on the installation of BIPV in the government's own buildings) might allow the 80 demonstration projects to be established over the next 10 years. Thus it might be realistic to expect the demonstration programmes contribution of 7.2 GWh/yr to be established by 2012 and possibly one or two years earlier (*Table 13-5*).

Table 13-5: Market Penetration of BIPV (GWh/yr)

Year	Minimum	Average	Maximum
2012	5.2	7.2	8.9
2017	13.1	16.0	19.2
2022	26.2	32.0	38.4

Over the next period (2012 to 2017) it is reasonable to assume that the cost-effectiveness of BIPV has improved to the point where it is commercially viable in an increasing number of applications. Given some continuing government support (and active promotion of successful projects), it is likely that the contribution would at least double to reach a total of 14.4 GWh/yr by 2017 (0.04% of 1999 electricity consumption). Similarly, the contribution of BIPV may be expected to double again by 2022.

13.3.4 Building Integrated Fuel Cells (BIFC)

Of all the technologies considered here, fuel cells are the least proven. They are comparatively untested in commercial applications internationally, and the technology is still evolving.

Nevertheless, it is worth considering providing support for a small number of BIFC demonstration projects. This would help to develop the technology and prove its performance in specific applications, in preparation for the time when it becomes cost effective.

A typical demonstration project might have an installed capacity of 0.5 MW, and an average annual output of 3.95 GWh (7.9 GWh/MW). This demonstrates the significant contribution that individual BIFC projects can offer compared to individual BIPV projects. Nevertheless, we can foresee no such installations in the short-term and only one in the medium-term, giving an overall contribution of 4.0 GWh/yr by 2012. There might be one further project by 2017 (7.9 GWh/yr total) and two more by 2022 (15.8 GWh/yr).

13.3.5 Other Technologies

This strategy focuses on the new and renewable energy technologies identified as being of special interest to Hong Kong under the Study on the Potential for Renewable Energies in Hong Kong, i.e. wind, solar PV, energy-from-waste and fuel cells. The potential and application of other technologies, such as solar water heaters, is being examined in separate studies.

13.3.5.1 Photovoltaic Power Stations

Photovoltaic power stations (PVPSs) are fundamentally different from building integrated PV (BIPV) in that they are not embedded generation, and so feed directly into the electricity supply network rather than making a (generally small) contribution to the electricity demand of the site where they are located. Although a PVPS will generally be substantially larger (in terms of output) than a BIPV installation, it will still be small compared to some of the other options considered (for example, wind power and energy-from waste).

Since PVPS installations demand a relatively large plan (land) area, they are not likely to find widespread use in Hong Kong. Nevertheless, some opportunities do undoubtedly exist. These include:

- ❑ On the roofs of large storage sheds (e.g. harbour area, railway workshops)
- ❑ On the proposed 'roof' of the airport rapid transit railway
- ❑ Some of the 'protected' slopes in Hong Kong.

An average project of this nature might have an area of 40,000 m² (say 200m x 200m, or 10m x 4 km), and an average annual output of 0.14 MWh/m². This implies a contribution of 5.6 GWh/yr for each installation.

Depending on the level of support, there might be a single installation by 2012 (5.6 GWh/yr), a further one by 2017 (11.6 GWh/yr total) and two more by 2022 (17.2 GWh/yr).

Development of PV power stations would require the enabling measures described previously to have been put in place. Given the land requirements, developers are likely to be restricted in number.

13.3.6 Options Summary

Embedded generation is likely to provide a smaller contribution to Hong Kong's renewable energy than larger, free-standing wind or energy-from-waste schemes, both because individual projects are much smaller in their power output, and because the economics of the technologies are generally less favourable at the present time. There is nonetheless significant potential to expand the use of these technologies, and demonstrate their application in a variety of buildings in preparation for when the technology has been improved further. Key steps are:

- ❑ To explore the potential for a BIPV programme that adopts the organisational and financing model demonstrated by the DSM programme;
- ❑ For the government to look for opportunities for inclusion of RE technologies in government buildings;
- ❑ For the option of using either public funds or an allocation from the renewable energy fund/account to co-finance BIPV installations to be examined;
- ❑ For these projects to be monitored and the experiences exchanged to promote learning

about the application of the technology to different building types;

- For the Inland Revenue Department to consider providing 100% depreciation allowances for RE investments.

13.4 SUPPLEMENTARY STRATEGY

The above sections outline key components of the recommended RE strategy to secure wide-scale adoption of RE technologies. That is, a set of enabling measures to create the basic conditions for a RE market to operate, plus a number of technology-specific actions focused on barriers associated with wind, solar PV, etc. Grid access and market creation have been identified as key issues requiring action and support from the government to promote wide-scale adoption RE in Hong Kong.

Noting the issues and constraints associated with the current regulatory regime with respect to grid access, however, it is recommended that the government should also investigate the feasibility of standalone RE power supply schemes for district-based or specific applications. This supplementary strategy makes use of government's position as a large electricity consumer as well as the procurement agent for the planned waste treatment facilities.

As noted earlier, the government is evaluating technical options for large-scale integrated waste treatment facilities, including possibly thermal treatment technologies coupled with power generation in the order of tens to hundreds of MW. Given that energy-from-waste (which is a biomass technology) would have relatively stable output, there is the possibility for this to be used in conjunction with other intermittent or variable renewable energy sources (e.g., solar, wind) in particular applications. For example, a new development (e.g., industrial estate) may be supplied by such an integrated district-based RE supply system. Another option would be to co-develop an integrated RE generation system with future energy-intensive (government owned) facilities (e.g., water treatment plants) such that an end user(s) of the RE power can be assured.

Further, while this Study focuses on renewable energy resources that are available **locally**, the Government may consider requesting power suppliers to import (from the Mainland, for example) electricity generated from renewable sources, if deemed desirable. This and the other supplementary strategy options mentioned above may be further investigated.

13.5 PROMOTION AND AWARENESS-RAISING ACTIONS

Deployment of RE projects will be greatly facilitated by a wider awareness of RE sources and technologies, and the contribution that they can make to Hong Kong's environmental and energy objectives. The promotional strategy action plan is therefore an integral part of the overall RE Strategy, and will include both *general awareness-raising* and *specific promotional actions* triggered by the successful implementation of actions under the broader RE strategy. The proposed promotional strategy involves:

- *Short-term* (from the present to the introduction of the enabling measures to address grid access and pricing) actions, aiming to secure political and institutional support for the RE Strategy and to alert the public and consumers to the benefits offered by RE. These would include presentations to the legislature and decision-makers, demonstration projects to raise public awareness, attitude survey of commerce and

industry, setting up of RE website, as well as networking with interested Mainland and overseas parties;

- ❑ *Medium-term* (for a period of about five to seven years after the previous phase) actions, aiming to capitalise on the implementation of the enabling measures (or launch of the RE market) and technology-specific programmes for wind, solar, etc. These could involve a keystone launch event, such as a RE fair, and other school educational programmes, consumer awareness campaigns, departmental briefings, as well as publicising the results of earlier demonstration projects;
- ❑ *Long-term* actions. The promotional agenda will inevitably evolve as circumstances change. The focus and content of the strategy will be reviewed periodically to ensure its relevance.

14 TARGETS

14.1 DEFINING TARGETS FOR RENEWABLE ENERGY

It is common for national and regional renewable energy policies to incorporate targets for the contribution that RE technologies will make to meeting overall energy demand. These targets act as reference points against which progress can be measured, and can be used to stimulate progress away from the 'business-as-usual' scenario.

The definition of 'renewable energy' used is an important issue in relation to the setting of targets. In the short term it may be appropriate to adopt a broad definition of 'renewable' energy that, for instance, includes energy-from-waste schemes. However, it is suggested that this broader range of technologies may be brought together under a non-contentious but descriptive umbrella term such as 'alternative energy sources'. The term 'renewable' can then be restricted to references to genuinely renewable sources such as wind and solar. Clarity on such terms and their meaning is important in communications with the public and NGOs, and in retaining the credibility of environmental claims made for the technologies and programmes concerned.

Targets can be defined on a top-down or bottom-up basis (see *Box 14.1*). In markets that are not yet well-developed it is generally most appropriate to set targets on the basis of the projects that are likely to come 'on stream' within a given period and under a specific scenario for market support (bottom up approach). These targets will generally be set for different technologies, and then aggregated to define an overall target. As the market matures, it becomes possible (and more appropriate) to set overall targets, initially for individual technologies based on policy objectives (top down approach), leaving it to the market to determine how that target will be met. This may then develop further into a single 'top down' target, with the market deciding the balance between technologies as well as how the contributions of each technology will be met.

The small size of Hong Kong and the early state of development of the RE market implies that initially targets must be based on the contributions that individual technologies (and, in the short term, individual projects) can realistically be expected to make. This approach is highly sensitive to the assumptions that are made, since (for example) the deferral or loss of one major project can have a measurable, and possibly irrecoverable, impact on progress towards the overall target that has been set. It is therefore important at this stage not simply to set a single target for each technology, but rather to consider a number of different scenarios in order to give a range of targets in each case. The presentation of the overall target as the aggregate of the technology-specific targets will make these issues clear.

Setting targets for the strategy is a challenging task. There are a number of reasons for this, including:

- ❑ Hong Kong is at the beginning of renewable energy learning curve, with very little installed renewable generation;
- ❑ There is uncertainty about whether the necessary 'enabling environment' for renewables can be created – the necessary dialogue with the power companies is still in its early stages;

- ❑ There are many uncertainties relating to the extent and speed with programmes can be brought forward.

Box 14.1: Approach to Setting Targets for Renewable Energy Uptake

Defining and setting targets for RE uptake needs to be addressed both from the top-down and from bottom-up. Top-down assessments identify an overall target for the likely contribution of RE to the country's national energy production or energy use targets. Bottom-up targets are based around more detailed assessments of the likely contribution of different technologies, and the impact of changes in policy and support may alter the assessment.

National targets (top-down)

The European Commission agreed a target in 1997 to double the use of RE by 2010. The subsequent Directive sets out indicative (non-binding) targets for each member state, derived from current levels of RE use and scenarios and predictions for new RE uptake. All have now established policies and strategies for achieving their allocated target. For example:

In Holland a 1997 White Paper on Renewable Energy outlined a strategy for developing renewable energy, together with targets for 2020. These targets were updated in 1999 and require renewable energy to provide 5% of national energy demand by 2010, and 10% by 2020. The major component is provided by a substantial increase in electricity from RE, up from 3.5% in 1997 to 12% of total electricity demand by 2010.

The UK has established an objective to meet 5% of electricity requirements from RE sources by the end of 2003, rising to 10% by 2010 (subject to the cost to consumers being acceptable). This objective is set as part of a wider approach to climate change, with a range of initiatives to support a more sustainable approach to energy use.

Bottom-up, regional resource assessments

These targets may be established either in parallel with, or independently of, national targets. Regional targets are particularly common in countries with federal systems, where regional and local authorities have a greater degree of autonomy to implement RE support initiatives.

Germany: Each federal state (Lander) has defined its own programmes for RE support, usually in conjunction with energy conservation measures. Berlin, for example, established its own energy policy in 1994. This supports an increase in the use of RE and a reduction in CO₂ emissions by 25% per person from 1990 levels by 2010.

Spain: The national Energy Saving and Efficiency Plan (1991-2000) aimed to increase the overall use of RE by the equivalent of 1.1 million tonnes of oil by 2000. Support was endorsed and implemented at regional level. In the Navarre region, for example, the regional government developed an Energy Plan specifying that by 2005 all electricity generated in Navarre will come from RE sources, of which about 50% of electricity will be from wind energy.

Technology-specific target assessments

This approach draws out the specific differences between RE technologies at different stages of commercial development. For example:

The UK's national resource and targets categorises technologies according to whether they are considered to have potential for exploitation in the short, medium or long term. The distinction lies in the degree of commercial viability that each technology has reached. Short term technologies include onshore wind and waste technologies (landfill gas, energy from waste), requiring little or no further financial support. PV and offshore wind are still not economically viable without financial support, and the government therefore considers these technologies to be medium term. Fuel cells are still at an early stage of development and demonstration and are considered as medium-long term technologies.

14.2 RENEWABLE ENERGY TARGETS

The strategy details a set of generic ‘enabling’ actions to establish minimum viable conditions for a market in renewable energy, and bundles of technology-specific actions designed to address barriers to individual technologies.

The renewable energy penetration analysis reported within the strategy text suggests that local ‘renewable’ energy sources (including energy-from-waste technologies) could, on reasonable assumptions and with a positive operating environment, contribute 261 - 686 GWh of electricity by 2012, 417 - 1,303 GWh by 2017 and 699 - 1,536 GWh by 2022 (see *Table 14-1*). By far the largest single component is EfW technologies.

Table 14-1: Summary of Contributions from Local RE Sources (GWh/y)

Source	2012	2017	2022
Large Scale Systems			
Onshore Wind	6	43	116
Offshore Wind	7	84	245
Energy-from-waste (Landfill Gas)	231-184	254-161	273-178
Energy-from-waste (Thermal Treatment ¹)	0-472	0-932	0-932
PV Power Stations	6	12	17
Sub-total:	250 - 675	393 - 1,232	651 - 1,488
Small scale (distributed) systems			
Building Integrated PV	7	16	32
Building Integrated Fuel Cells	4	8	16
Sub-total	11	24	48
TOTAL	261 - 686	417 - 1,256	699 - 1,536
Percentage of 1999 electricity consumption	0.735% - 1.932%	1.175% - 3.538%	1.969% - 4.327%

On this basis, it is suggested that, at least *initially*, targets of local RE (including energy-from-waste) contribution to annual power demand (against the baseline year of 1999) should be set at:

- ❑ 1% by 2012;
- ❑ 2% by 2017; and
- ❑ 3% by 2022.

In terms of overall energy supply, these ambitions may seem modest. They may, however, be regarded as prudent targets for renewable energy development, subject to the assumptions outlined above. Credible targets are better than those that are unattainable.

¹ It is noted that development of energy-from-waste technology is still under a separate study, and no decision has been made as to whether such technology will be adopted in future.

In considering the targets it should be recognised that:

- ❑ Hong Kong is at a very early stage in the evolution of its renewable energy sector and has not seen demonstration projects in several of the key technologies;
- ❑ Projects take a significant time to bring to fruition, especially where they bring new challenges in approval and consultation;
- ❑ More might be achievable faster if large investment capital was made available – but equivalent environmental gains are likely to be achievable more cheaply by other means, and it is necessary to raise awareness and build support for RE in tandem with the first generation of projects.

Selection of viable demonstration projects, and their successful implementation will lay the groundwork for a more ambitious expansion of the RE programme after the initial years. These targets are framed in the context of current plans for the waste management strategy. Waste-to-energy projects form a large part of the expected alternative energy supply. If “thermal waste treatment with energy recovery” is not adopted, there will be additional arisings of landfill gas that, if captured and converted to electricity, will go some way towards overcoming the deficit but will not close the gap. However, substantial changes in the waste management strategy may mean that the renewable energy targets would require review.

PART E

CONCLUSIONS AND RECOMMENDATIONS

15 CONCLUSIONS

15.1 TECHNOLOGY REVIEW

The benefits of using NRE technologies are many, mostly because of their virtually inexhaustible nature of resources. The NRE resources, particularly solar and wind, are broadly available in Hong Kong. In deed certain technologies tend to have more potential resource of one type than other does. The following summary concludes an overview of each technology.

15.1.1.1 *Solar PV*

Solar PV technologies appear the potential for wide-scale application and could potentially be installed as BIPV systems for residential, commercial, industrial, and government, institutional and community applications, as well as non-BIPV generation systems for roads and open space. The PV power generation potential in Hong Kong has been estimated at 5,944 GWh each year, representing about 17 percent of the annual power demand in Hong Kong in 1999.

15.1.1.2 *Solar thermal*

“Solar thermal electricity generation” technology is not considered suitable for wide-scale application in Hong Kong.

While solar water heating technology does not produce electricity, it could reduce electricity (and gas) consumption and indirectly conserve fossil fuels. The opportunities for retrofitting existing building with centralised solar water heating facilities would be predominantly for specific uses such as hotels, hospitals, sports centres, etc., where a centralised water heating and storage system might be more practicable.

15.1.1.3 *Wind*

The options assessment has indicated that, for wind energy technology, the option for rural area wind farms in a linear arrangement on mountain ridges may be considered. Assuming that 1,000 such wind turbines could be installed in high wind resource areas in the SAR (total 393 km²), the total electricity output would be up to 2,630 GWh/yr (~ 7% of the SAR's total annual demand in 1999).

Individual machines in urban areas can be significant in Hong Kong, with a theoretical resource for urban wind turbines for the whole of Hong Kong is estimated around 3,000 GWh/yr. This is equivalent to between 8 percent of Hong Kong's electricity demand in 1999.

Near-shore wind farms and offshore wind farms are recommended for further site specific evaluation. The total sea area potentially available for wind turbine installation is approx. 744 km². This means 8,480 GWh/yr (~ 24% of the SAR's 1999 annual power demand) if all these areas were installed with wind turbines.

15.1.1.4 Biomass

In conclusion, biomass energy technology is unlikely to be appropriate for wide-scale application in Hong Kong. It has been estimated that no more than 1.3 percent of Hong Kong's electricity need in 1999 can be met by biomass crops, even if 400 km² of land area (36 percent of the total area of Hong Kong) were utilised and converted into energy crop plantations. Further, the actual land area that may be available would be much less, if one were to consider the environmental constraints, soil conditions, and topography.

15.1.1.5 Energy from Waste

Thermal processes such as combustion and gasification are much more efficient than landfilling in terms of energy recovery. Irrespective of the technologies adopted, MSW is a significant energy resource in Hong Kong. In 2007 under the WRP, it has been estimated that up to 1,181 GWh of equivalent electrical energy could be generated. This is equivalent to about 3 percent of the annual electricity demand in 1999.

Energy recovered from anaerobic digestion of sewage sludge and livestock waste is relatively small compared to the MSW, this may be utilised in-plant to minimise demand from external sources.

15.1.1.6 Small scale Hydro

The small hydro option of the run-of-river waterwheel scheme is not considered as a technology suitable for wide scale application in Hong Kong, because the energy resource of the waterwheel scheme is not practicable, only 170 MWh/yr for the total Hong Kong water catchment.

Likewise, the retrofit small-scale hydro option is recommended for further evaluation, by interested parties such as Water Supplies Department. In a comparison of the two technology options in terms of energy resource, the total resource calculated for the proposed retrofit sites is 7.5 GWh/yr, representing 0.02 percent of total annual power demand in Hong Kong in 1999.

15.1.1.7 Geothermal

Currently, hydrothermal resource technology is the only geothermal technology with a proven and established history. All other geothermal technologies are still in the developmental stage. However, Hong Kong does not have a meaningful hydrothermal potential, as is evidenced by the absence of volcanoes, geysers, and hot springs.

15.1.1.8 Tidal

An option of building a dam across the Tolo Harbour to harvest the tidal energy has been formulated. The site will allow minimum amount of effort to build a dam across to form a basin with maximum water storage for possible tidal power generation. Calculation shows that the conceptual tidal power plant will generate electricity less than 0.15 percent of the total power consumption in Hong Kong in 1999. In view of the negligible resources potential in Hong Kong and the likely constraints, tidal energy is considered not suitable for wide-scale community use in Hong Kong at present.

15.1.1.9 Wave

It is concluded that electricity from wave energy is considered not suitable for large-scale community use in Hong Kong. However, site-specific systems could be considered for application at, for example, remote island locations.

15.1.1.10 Fuel Cells

Fuel cells could potentially be installed as BIFC systems for residential, commercial and industrial applications, as well as utility distributed and central generation. A likely upper bound potential for fuel cell power generation in Hong Kong has been estimated at 589 MW. This is equivalent to about 7 percent of the peak power demand in Hong Kong in 1999.

15.1.1.11 Independent Energy Storage System

This technology in the hybrid use of new and renewable energy resources is less mature than the NRE technologies themselves. As hybrid systems are essentially a combination of NRE resources and technologies, and many are only “concepts” at this stage, the combined efficiencies and costs of hybrid system are unproven. Nevertheless, the hybrid use of solar PV and wind power with fuel cells may be further evaluated for application in a remote area or offshore island community in Hong Kong, if deemed appropriate.

15.1.2 Potential NRE Options for Wide Scale Applications

It is concluded that the following NRE technologies are potentially suitable for wide scale application in Hong Kong:

- ❑ Solar photovoltaic systems
 - BIPV; and
 - non-BIPV;
- ❑ Wind energy
 - Rural wind farms in linear arrangement;
 - Individual urban wind turbines; and
 - Near-shore wind farms;
- ❑ Energy-from-waste; and
- ❑ Building Integrated Fuel Cells

15.1.3 Technologies for Other Applications

The Study has found that the following RE technologies may be applicable at specific sites, subject to case-by-case evaluations by interested parties:

- ❑ *Solar water heating* at building developments, particularly at buildings (e.g., hotels, hospitals, sports centres) where a large centralised hot water system is available;
- ❑ *Small hydroelectric* systems, particularly retrofit schemes at water treatment facilities where excess hydraulic energy is available; and
- ❑ *Wave power* systems for remote areas, particularly at offshore islands in the southern part of the SAR.

15.1.4 Others

Technologies that do not appear to have potential for wide scale application in Hong Kong include:

- ❑ Solar thermal electricity generation;
- ❑ Biomass (energy crops);
- ❑ Geothermal energy; and
- ❑ Tidal power.

15.2 LEGAL & INSTITUTIONAL ISSUES

The Study has found that RE resources could make a meaningful contribution to meeting Hong Kong's long-term power demand. If the set of (mostly) non-technical barriers identified in this Study are addressed, RE technologies could offer useful environmental benefits and provide alternative energy sources for Hong Kong.

There are opportunities for development of renewable energy projects under the current regulatory framework for electricity, and there is also interest in the greater use of the technologies concerned. These opportunities may involve grid-connected or standalone systems, and include 'quick wins' such as making productive use of large quantities of landfill gas that are currently collected but flared off for want of a market for the energy. It was also found that the government could exercise a powerful and positive influence in the RE market by virtue of its position as Hong Kong's largest electricity purchaser and as the procuring agent for major waste management facilities that may feature energy recovery.

However, for any of these opportunities to be realised on a meaningful scale, especially those involving grid-connected systems, there is a need for the government, electricity companies and project developers to work together on a set of enabling actions to create a supportive and profitable business environment in which RE projects can operate. These actions focus on defining terms for third party access to the grid, and on creating a mechanism by which power companies and promoters can recover the incremental costs of RE. The same issues have been addressed in many other countries and both lessons of experience and technical guidance are available.

With an enabling framework and the right incentives in place in the near term, the following period can be used effectively to:

- ❑ Demonstrate a wide range of alternative energy technologies,
- ❑ Educate the public about their benefits, and
- ❑ Build community support for future expansion.

Without such a framework or a means of selling the power generated, it is unlikely that RE in Hong Kong will develop far beyond a few small-scale grid-connected projects, or possibly one or two district-based standalone supply schemes. There is therefore a necessary role for government in creating the market for renewable energy. A RE Strategy has been presented that include various options, including those that need not be tied into the existing regulatory framework (e.g., Voluntary Green Power Scheme). There are also choices in the extent to which government wishes to back its stated support for RE or alternative energy sources with the purchase of power from these sources.

In a favourable business climate, alternative local energy sources could meet the equivalent of 1% of 1999 energy demand in 2012, 2% in 2017 and 3% by 2022.

16 RECOMMENDATIONS

It is recommended that:

- ❑ Government should adopt a formal policy position with respect to renewable or alternative energy. In particular, targets of local RE contribution to electricity demand (against baseline year of 1999) of 1%, 2% and 3% for 2012, 2017 and 2022, respectively, are proposed;
- ❑ The proposed near term awareness raising and promotional activities should be implemented as soon as possible. Key action items would include:
 - Presentations to the legislature and other decision makers to secure political and institutional support;
 - Demonstration projects (e.g., wind, BIPV, etc) to raise public awareness; and
 - Attitude survey of commerce and industry as potential investors.
- ❑ Technology specific support measures should be initiated at the earliest opportunity, including:
 - A comprehensive study to identify possible sites for wind projects, and to evaluate the more promising sites in greater detail;
 - Development of technical and planning guidelines for RE project developments, including wind and building integrated systems.
- ❑ A dialogue between Government and the power companies should be established as soon as possible (one way is to take the opportunity of the 2003 SCA interim review) about the creation of the necessary enabling conditions. Key issues to be addressed would include:
 - Grid access; and
 - Power purchase agreements.
- ❑ Government undertakes an extensive public consultation exercise (involving consumers as well as power suppliers) on the proposed financing options (e.g., general levy, voluntary green power schemes, etc) so as to:
 - Reach a decision on the preferred option; and
 - Constitute a funding mechanism to meet the incremental cost of RE.
- ❑ The RE Strategy and action plan be regularly updated to reflect evolving conditions and changing circumstances.
- ❑ A combined programme is recommended as shown in *Figure 16-1*. The first phase of the

programme is critical since without the key measures for market creation outlined above, the prospects for meaningful development of renewable energy sources will be bleak.

Key milestone in the first phase programme are:

- Determination within government of the preferred renewable energy financing mechanism; and
- Successful engagement of the power companies such that the enabling environment for renewable energy development is created.

If successful these would trigger:

- Reasonably rapid development of landfill gas resources;
- Preparation for pilot projects in wind energy; and
- The advent of building integrated renewable energy demonstration programme.

Major events in the second phase of the programme are:

- The expiry of the current SCAs in 2008, and the commencement of a new generation of regulatory regimes; and
- The expected commissioning of the first energy-from-waste incinerators in 2012.

Detailed programming beyond this phase is not appropriate at this stage. The penetration analysis has made a set of assumptions about technology development and investment based on the revised or renewed regulatory regime for electricity being at least as favourable to renewable energy sources.

Figure 16-1: Renewable Energy Strategy & Action Plan - Consolidated Programme

Action	Who	Short Term	Medium Term	Long Term
ENABLING MEASURES				
Grid Connection				
Agreed technical standards for grid connection	Govt, Power Companies	[Short Term]		
Agreed cost of connection principles	Govt, Power Companies	[Short Term]		
Monitor operation of technical standards & connection agreements	Govt		[Medium Term]	[Long Term]
Power Purchase				
Determine preferred basic model: Fund + levy or RE tariff	Govt	[Short Term]		
<i>Tariffs & Renewable Energy Fund (common component)</i>				
Initiate price review	Govt, Power Companies	[Short Term]	[Medium Term]	
<i>(negotiate reference tariff & supplementary feed-in rates by RE technology)</i>				
Funding analysis - Profile of call on funds vs. funding available	Govt	[Short Term]	[Medium Term]	
Determine fund operating rules & accounting protocols	Govt, Power Companies	[Short Term]	[Medium Term]	
Determine certification and metering procedures	Govt, Power Companies	[Short Term]	[Medium Term]	
<i>either</i>				
<i>Renewable Energy Tariff/Green Electricity Scheme</i>				
Conduct willingness to pay studies on renewable energy tariffs	Government	[Short Term]	[Medium Term]	
Determine feasibility/details of Govt purchase guarantee	Government	[Short Term]	[Medium Term]	
Negotiate parameters of scheme	Govt, Power Companies	[Short Term]	[Medium Term]	
<i>or</i>				
<i>Renewables Levy</i>				
Prepare proposals for general RE levy on tariffs	Government	[Short Term]	[Medium Term]	
Negotiate parameters of scheme	Govt, Power Companies	[Short Term]	[Medium Term]	
<i>all</i>				
Approval processes & preparation	Govt, Power Companies	[Short Term]	[Medium Term]	
Implementation	Power Companies		[Medium Term]	[Long Term]
Information campaign			[Medium Term]	[Long Term]
TECHNOLOGY-SPECIFIC PROGRAMMES				
Wind Energy				
Determine SCA (ANFA) / RE Fund finance for pilot projects	Government	[Short Term]		
Commission & execute site selection study	Government	[Short Term]		
Development of proposals for pilot projects	Proj developer, power co.	[Short Term]	[Medium Term]	
Demonstration Project Selection	Government	[Short Term]	[Medium Term]	
Review/provide planning guidance + supporting material	Government	[Short Term]	[Medium Term]	
Awareness-raising programme, NGOs	Gov't, Proj. Developers	[Short Term]	[Medium Term]	
Demonstration Project Development	Project developers		[Medium Term]	[Long Term]
Demonstration Project Operation	Project developers		[Medium Term]	[Long Term]
Monitoring, dissemination & publicity	To be determined		[Medium Term]	[Long Term]
Scale up to new projects	Developers		[Medium Term]	[Long Term]
Energy from Waste				
<i>Landfill Gas</i>				
Confirm purchase guarantees/green tariff/connection terms	Govt, Power Co, Developers	[Short Term]		
Project preparation, including certification & metering arrangements	Developers, power co.	[Short Term]	[Medium Term]	
Construction & connection (various projects)	Developers, power co.		[Medium Term]	[Long Term]
Operation	Developers		[Medium Term]	[Long Term]
<i>Incineration with Energy Recovery</i>				
Creation of enabling environment - tariffs & connection	see above	see above	set by EFW project timetable	
Negotiate parameters of purchase guarantee option	Govt, power co, dev.			
Photovoltaic Power Stations				
Explore allocation of RE fund co-finance to pilot PVPS project	Govt/transport utilities /other		[Medium Term]	
Embedded Generation (BIPV etc.)				
Establish simplified approval process for embedded generation	Govt, Power Companies	[Short Term]	[Medium Term]	
Agree financing mechanism for demonstration scheme <i>(DSM II / public co-finance / allocation from RE Fund)</i>	Govt	[Short Term]		
Trial 'type approval' for BIPV products	Govt, promoters	[Short Term]	[Medium Term]	
Liaise with IRD on depreciation allowances for BIPV	Govt	[Short Term]	[Medium Term]	
<i>Private Buildings</i>				
Launch demonstration scheme + capital cofinancing			[Medium Term]	
-DSM phase II sub-component (option)	Govt, power co, building dev		[Medium Term]	
-RE Fund allocation	Govt, power co, building dev		[Medium Term]	
-Public cofinance	Govt, building dev		[Medium Term]	
<i>Government Buildings</i>				
Review Govt building programme for opps to incorporate RE	Govt	[Short Term]	[Medium Term]	
Determine finance protocols for BIPV in govt buildings	Govt	[Short Term]	[Medium Term]	
Extend demo programme to govt buildings	Govt	[Short Term]	[Medium Term]	
<i>General</i>				
Demo programme monitoring, evaluation and dissemination				[Long Term]
Promotion and Awareness - Raising				
				[Long Term]

APPENDICES

APPENDIX A - COST MODELS

Table A-1 summarises the assumptions and the levelised cost of electricity in each NRE option.

Table A-1: Summary of Levelised Cost of Electricity

NRE Option	Rationale	Levelised Cost of Electricity
For All Options	<ul style="list-style-type: none"> ⊙ All systems have 20-year lifetime. ⊙ O&M cost per electricity generated (HKD/kWh) and capacity factor for each option is constant throughout the whole analysing period. ⊙ 4% discount rate in base-case. ⊙ Exchange rate 1 USD = 7.75 HKD ⊙ The ultimate installed capacity is the minimum capacity of generation plant that can meet the annual resource potential. ⊙ Land cost is not included in any option. ⊙ Market penetration period is 10 years. 	-
BIPV	<ul style="list-style-type: none"> ⊙ Today cost of PV module is USD 3.5 to 7/W, and its projected cost in 2010 is USD 1.78 to 3.56/W. ⊙ Present Balance of System cost is USD 2.5 to 5/W, and its projected cost is USD 1.22 to 2.44/W in 2010. ⊙ O&M cost is USD 0.004/kWh. ⊙ Capacity factor is 10%. ⊙ The ultimate installed capacity is 6,112 MW. 	HKD 2.23/kWh to HKD 4.1/kWh
Non-BIPV	<ul style="list-style-type: none"> ⊙ Today cost of PV module is USD 3.5 to 7/W, and its projected cost in 2010 is USD 1.78 to 3.56/W. ⊙ Present Balance of System cost is USD 2.5 to 5/W, and its projected cost is USD 1.22 to 2.44/W in 2010. ⊙ O&M cost is USD 0.004/kWh. ⊙ Capacity factor is 10%. ⊙ The ultimate installed capacity is 637 MW. 	HKD 2.23/kWh to HKD 4.1/kWh
Individual Urban Wind Turbines	<ul style="list-style-type: none"> ⊙ Present turbine cost is USD 2,200 to 4,400/kW, and its projected cost is USD 880 to 1,760/kW in 2010. ⊙ Balance of System cost is 40% of turbine cost. ⊙ O&M cost is USD 0.03/kWh. ⊙ Capacity factor is 30%. ⊙ The ultimate installed capacity is 1,200 MW. 	HKD 1.32/kWh to HKD 2.32/kWh

Rural Wind Farms	<ul style="list-style-type: none"> ⊙ Present turbine cost is USD 704 to 1,408/kW, and the price drops 4% per year between 2001 – 2010. ⊙ Present Balance of System cost is USD 211 to 422/kW, and its projected cost is USD 135 to 270/kW in 2010. ⊙ O&M cost is USD 0.005/kWh. ⊙ Capacity factor is 30%. ⊙ The ultimate installed capacity is 1,000 MW. 	<p>HKD 0.20/kWh to HKD 0.35/kWh</p>
Nearshore Wind Farms	<ul style="list-style-type: none"> ⊙ Present capital cost is USD 1,693 to 3,386/kW, and its projected cost is USD 1,271 to 2,542/kW in 2010. ⊙ O&M cost is USD 0.008/kWh. ⊙ Capacity factor is 30%. ⊙ The ultimate installed capacity is 3,067 MW. 	<p>HKD 0.36/kWh to HKD 0.64/kWh</p>
Offshore Wind Farms	<ul style="list-style-type: none"> ⊙ Present turbine cost is USD 704 to 1,408/kW, and the price drops 4% per year between 2001 – 2010. ⊙ Present Balance of System cost is USD 211 to 422/kW, and its projected cost is USD 135 to 270/kW in 2010. ⊙ Cost of reclamation for artificial island is HKD 299,850 to 599700/kW. ⊙ O&M cost is USD 0.005/kWh. ⊙ Capacity factor is 30%. ⊙ The ultimate installed capacity is 161 MW. 	<p>HKD 9.00/kWh to HKD 18.00/kWh</p>
BIFC	<ul style="list-style-type: none"> ⊙ Present fuel cell cost is USD 6,000 to 12,000/kW, and its projected cost is USD 2,000 to 4,000/kW in 2004. ⊙ Additional capital equipment cost is USD 250 to 500/kW. ⊙ O&M cost is USD 0.01 – 0.015/kWh. ⊙ Capacity factor is 60%. ⊙ The ultimate installed capacity is 577 MW. ⊙ Fuel gas price is HKD 0.208/MJ, and price escalation is 3%. 	<p>HKD 2.03/kWh to HKD 2.4/kWh</p>

APPENDIX B - TECHNICAL REQUIREMENTS FOR GRID CONNECTION OF LARGER RE GENERATION

Size of RE generation sites in Hong Kong

In order to integrate active generation into a power system, numerous technical issues need to be addressed, but the size of the generation tends to influence the extent of the interface requirements. For grid systems of the nature of the Hong Kong grid, there is no evidence that generation of significant size is impossible to connect from a technical or operation point of view.

RE from landfill gas generation and wind power may offer a small but significant scale of generation: they may offer 1~5MW of capacity at various locations, connected at 11kV or 33kV. The technical interface requirements will be moderately stringent in order to assure that the grid is both able to absorb the power export, and that the grid itself is not adversely effected by the generation connection.

Large concentrations of RE plant capacity – say 5~50MW, connected at 33kV or 132kV, would be unusual, except for large-scale incineration plant and possibly large-scale wind-power. The technical requirements for its connection are stringent and are also outlined below.

(For very small plant – e.g. embedded photovoltaic units – the relatively simple technical connection issues are outlined in Appendix B).

Connection Agreements

Invariably, most generation plant will be the subject of site-specific connection agreements, (as well as commercial agreements on the purchase and timing of exports etc.). The connection agreements will specify the technical, operating and safety and other requirements for parallel operation with the grid. These will be underpinned by agreements on ownership of interface plant, safety and control responsibilities, access and maintenance obligations. They may make reference to licence obligations and technical standards.

Typical requirements

A typical set of requirements will require the planning of the grid connection to comply with technical and planning/design standards. The norm is for these standards to be IEC standards, or their equivalent, and to be in the public domain.

Fault Level Studies - Experience indicates that a key issue is that of fault level contributions from the RE plant. In some cases this places strain on existing switchgear (which was probably not specified with embedded generation in mind) and studies have to be paid for by developers to assess the system reinforcement costs to be born by the developers.

Standards for voltage control and the generators ability to operate within a specified frequency range, and not to create harmonics beyond a given technical limits will be in place. (The use of variable speed drives for fans etc. mean that some plant will cause

significant harmonics). Similarly voltage flicker and EMC requirements will be needed, as will limit to the step voltage changes that may be imposed by the plant's operation.

Island Mode operation of the plant and surrounding grid system are not the norm for distribution systems – although possibly generation with more than 50MW capacity may be required to be able to run in this mode, but again as part of a commercial agreement. This has implications for earthing and its operation and for the re-synchronisation of the plant when the grid is re-energised.

System stability will be an issue for larger plant, embedded within extensive systems. Whilst the Hong Kong system is not geographically large, the need for such studies will remain. Plant that may become unstable may have to be disconnected from the grid. Stability and fault level issues will therefore influence the design of larger generation plant. Connection costs therefore need to include such study costs and to allow for the time it should take to perform these.

It is not usual for RE output to be used to secure demand, and single leg connections are the norm. However, the grid operator may wish to obtain the developers agreement to a less secure connection than normal for the size of load flows being considered. The nature of the commercial agreement – for firm power for example – will influence this decision.

APPENDIX C - TECHNICAL GRID CONNECTION ARRANGEMENTS FOR SMALL ACTIVE INVERTER CONNECTED SOURCES

The inverter, as the key component of the interface between the PV and the grid, should be subject to various grid standards to make sure that an acceptable quality of grid supplies to all customers is maintained. (Note that there is an IEC standard for Photovoltaic Systems Interface with Utility Systems – IEC 1727:1995).

A typical technical standard for the connection of small equipment will cover the items discussed below.

Automatic Protection and Disconnection

The main concern is that, in the situation where the grid fails, the PV inverter systems must not continue to feed power into the grid – this is an operational safety requirement aimed at protecting anyone accidentally in contact with the grid system, and operators who are not working “live line”.

For small simple systems, this implies that the inverter should stop operation and be physically disconnected – electronic switching is insufficient for most grid operators, and some physical contact opening is needed. The equipment used for disconnection needs to meet specified IEC standards or their equivalent.

The Technical Standards should require the inverter to contain standardised “loss of grid” protection that ensures closedown of the inverter within a specified time (e.g. 0.5 second) and also prevent reconnection with a specified period (to allow automatic grid system operations). The inverter needs to be able to withstand grid re-connection without notice.

Automatic Protection – it is also reasonable to specify limits to operating voltage and frequency, beyond which the inverter is automatically disconnected.

Power Quality

All grid operators maintain standards for power quality. The main causes of problems are customer’s equipment, and standards are set for this. PV equipment is not (generally) exceptional in relation to these requirements and, quite reasonably, should comply with these general standards for -

- ❑ Harmonics; the equipment must not cause harmonics on the grid system in excess of normal standards for all customer’s equipment connected to the grid;
- ❑ Power-factor; it is normal to specify that the power-factor of the active source is limited - this assists in maintaining the grid at sensible voltage levels;
- ❑ Voltage Flicker and Electromagnetic Compatibility – these requirements are usually specified in standards for all equipment;
- ❑ DC Injection – it is not unreasonable to require disconnection of inverters if they

demand more than a small direct current component of supply from the grid. An isolating transformer might be recommended, but there are less expensive solutions.

Operation and Safety

Grid operators will require access to a means of isolating the active generation from the grid – for safety of operation. They may also require some safety labelling and information to be available at the isolation point. It is also normal to require customers to re-test inverter equipment if there is a problem on the grid associated with power quality or safety issues. With the same aim of safety, the equipment earthing also needs to comply with Codes of Practices and wiring regulations.

Commissioning and Acceptance Testing

- ❑ Testing of automatic protection
- ❑ Power quality
- ❑ Standards
- ❑ Islanding

Approval and Type testing

Most customers will wish to install standard equipment, and if type approved. Grid operators may still require site commissioning tests (witnessed by the grid operator) and a connection agreement. If large numbers of inverters are installed in one grid section, then it may be necessary for these manufacturers to provide statements on the immunity of their equipment from electrical interference from other inverters, and vice versa.

APPENDIX D - TARIFFS OFFERED BY HEC AND CLP - JULY 2001¹

Domestic Customer (Cents/kWh before adjustments for fuel costs and other issues)

HONG KONG ELECTRIC	
Up to 170 kWh per month	89
Next 170 kWh	97.8
Next 400kWh	106.6
Next 400kWh	114.6
Further units	122.0

CHINA LIGHT AND POWER	
Up to 400 kWh per month	86.2
Next 600 kWh	93
Next 800kWh	99.6
Further units	108.2

General and/or Commercial Customers (Cents/kWh before adjustments for fuel costs and other issues)

HONG KONG ELECTRIC	
All units consumed	110.6

CHINA LIGHT AND POWER*	
Up to 5000 kWh per month	97.4
Further units	96.4

*Special arrangements for customers demanding more than 3000 kVA or consuming more than 20,000 kWh/month

¹ Tariff Data shown above is in the public domain - the above was obtained from CLP and HEC telephone advice lines.