

Digital and Addressable Lighting Control at Kowloon Bay Indoor Games Hall

Prepared by Martin Wu Kwok-tin

Energy Efficiency Office, Electrical & Mechanical Services Department (August 2003)

1. INTRODUCTION

With the kind permission of Leisure and Cultural Services Department (LCSD), Energy Efficiency Office (EEO) of Electrical and Mechanical Services Department (EMSD) completed a pilot lighting project in 2002 at Kowloon Bay Indoor Games Hall (KBIGH). The new lighting system made use of the latest T5 lighting technology for illuminating the high ceiling games hall. As compared with the existing high-bay lighting using High Intensity Discharge (HID) lamps, the new high output T5 lighting system was found to be more energy efficient and offered many other benefits which provide users of the games hall a more comfortable visual environment for their sporting activities.

There were totally 72 high-bay HID luminaries existing in the games hall; half of the lamps were 400W metal halide and the rests were 250W high pressure sodium (SON) lamps. The new T5 lighting system included 160 special impact resistant luminaries accommodating 2x80W high output T5 lamps and digital dimmable electronic ballasts.

Power consumption was 25kW for the existing lighting system. Measurement on site for the new T5 lighting system at 500 lux lighting level was 13.5kW, which represents a power reduction of almost 46% in lighting. Other than energy saving, improvement in the lighting quality in terms of glare, colour appearance and colour rendition were also recorded.

A new intelligent lighting control system, namely, Digital Addressable Lighting Interface (DALI) had also been introduced into the pilot project. The DALI control system achieved extra energy saving and flexibility on the utilization of the games hall by dimming to various functional needs.

Surveys were also carried out to collect users' opinion on the new lighting system. Majority of the users' feedback was in favour of the new T5 lighting system. General comments included brighter than before, more comfortable, less glare, softer visual environment and better colour appearance.

2. EXISTING LIGHTING SYSTEM IN KOWLOON BAY INDOOR GAMES HALL

The arena in Kowloon Bay Indoor Games Hall (KBIGH) can be arranged in combinations of 8 badminton, 2 basketball or 2 volleyball courts. The existing lighting installation in KBIGH consists of 36 numbers 400W metal halide lamps and 36 numbers 250W high pressure sodium (SON) lamps mounted inside the industrial type high-bay luminaries with parabolic reflectors. Fig. 1 and Fig. 2 show the existing lighting installations in the arena with HID lamps. The metal halide and SON luminaries were designed to mount in pair adjacent to each other for colour blending. The layout of the high-bay luminaries was designed to provide an average illumination level of 500 lux at floor level. The actual average illumination level measured on site was 473 lux and the installed lighting load was about 25 kW. All existing

HID lamps were switched on for almost the whole opening hours (i.e. 7:00 am to 11:00 pm) of the game hall because these HID lamps need at least 5 minutes warming up period to start up. Instant re-strike after switching off or after a power interruption is also not possible.

The colour appearance of metal halide lamp is typical cool white (6000°K) and that for SON is yellow (2000°K). Neither metal halide lamps (too cool) nor SON lamps (too warm) are suitable to be used alone for indoor games halls lighting and they are therefore employed in pair for colour mixing and to create an appropriate visual environment for sporting activities. Metal halide lamps are also characterised by their good colour rendering property (essential for live TV broadcasting) but less efficacy (76 lm/W). SON lamps have relatively poorer colour rendition (rich in yellow/orange spectrum) and possible shift of colour appearance in operation but much higher efficacy (100 lm/W).



Fig. 1: Existing lighting installations with HID lamps at KBIGH



Fig. 2: Existing HID lamps and high-bay luminaires at KBIGH

3. HIGH-OUTPUT T5 FLUORESCENT LUMINAIRES

Tubular fluorescent lamps are essentially the opposite of “point-source” HID lamps and are regarded as “linear-source”. They emit relatively diffuse light from long glass tubes. This characteristic of diffusivity has enabled fluorescent luminaires to dominate the market for lighting commercial, institutional and industrial spaces with ceilings less than 5 meters high. In recent years, however, the emergence of more intense and efficient T5 fluorescent lamps and of specially designed reflective luminaires (Fig. 3) has enabled fluorescent systems to break through the ceiling height barrier and compete directly with HID lamps in high ceiling indoor application.

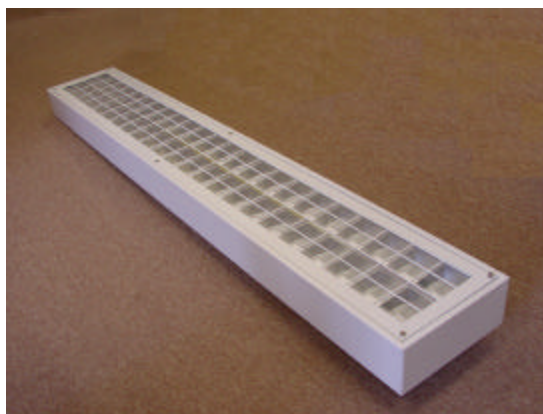

Fig. 3: 2x80W HO T5 Luminaire for high ceiling lighting

In this pilot project, we attempted to introduce 80W high output T5 lamps for indoor games hall lighting together with a new intelligent dimmable lighting control system. The new T5 lighting system was installed alongside with the existing HID lighting system. Both lighting systems had undergone intensive studies for comparison in terms of improvement in both energy performance and visual environment.

4. NEW HIGH OUTPUT T5 LIGHTING SYSTEM

The new pilot T5 fluorescent lighting system we used in KBIGH consisted of 8 continuous rows of 20 specially designed impact resistance T5 luminaires complete with 2x80W high output T5 lamps and digital dimmable electronic ballasts. The complete lighting installation with a total number of 160 luminaires at their full output capacity will provide an average illuminance of 800 lux at floor level. Fig. 4 shows the new lighting layout drawing and Fig. 5 indicates a photo of the new T5 lighting system being programmed using a lap top computer.

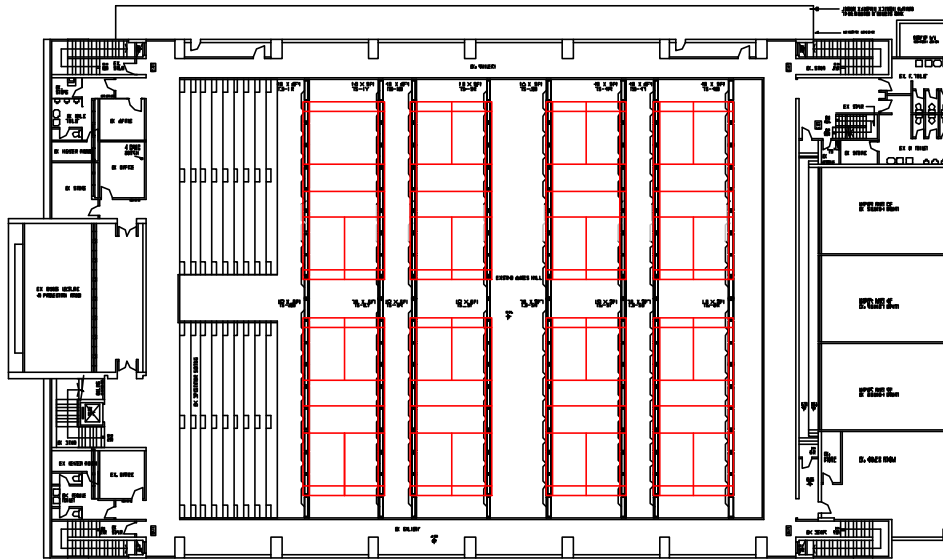

Fig. 4: New lighting layout of the games hall using high output 80W T5 lamps



Fig. 5: New lighting control system being programmed

5. DALI LIGHTING CONTROL SYSTEM

Digital Addressable Lighting Interface (DALI) was developed to overcome the problems associated with the analogue 1-10V control interface for dimming of electronic ballasts. DALI is a new international standard (Annex E under IEC 60929) that guarantees the exchangeability of dimmable electronic ballasts from different manufacturers. It provides a simple and digital way of communication among intelligent components in a local system in a way that that is free of interference.

DALI has been defined for:

- a maximum of 64 single units (individual addresses)
- a maximum of 16 groups (group addresses)
- a maximum of 16 scenes (scene light values)

Unlike most other intelligent lighting control system systems, the intelligent of DALI system has not been centralized for the purpose of defining the DALI-interface for control devices. This means that many of the set points and lighting values, such as individual address, group assignment, light scene values, fading times, etc., are stored within the individual ballast. The major advantages of DALI are:

- Simple wiring of control lines (no polarity, no separate conduit/trunking)
- Control of individual units (individual addressing) or groups (group addressing) is possible
- A simultaneous control of all units is possible at any time (through broadcasting addressing)
- No interference of data communication due to simple data structure
- Logarithmic dimming behaviour to match human eye's sensitivity
- No need of external relay (except for controlling equipment other than lighting system, e.g. air-conditioning, curtain, projector screen, etc.)
- Very user friendly

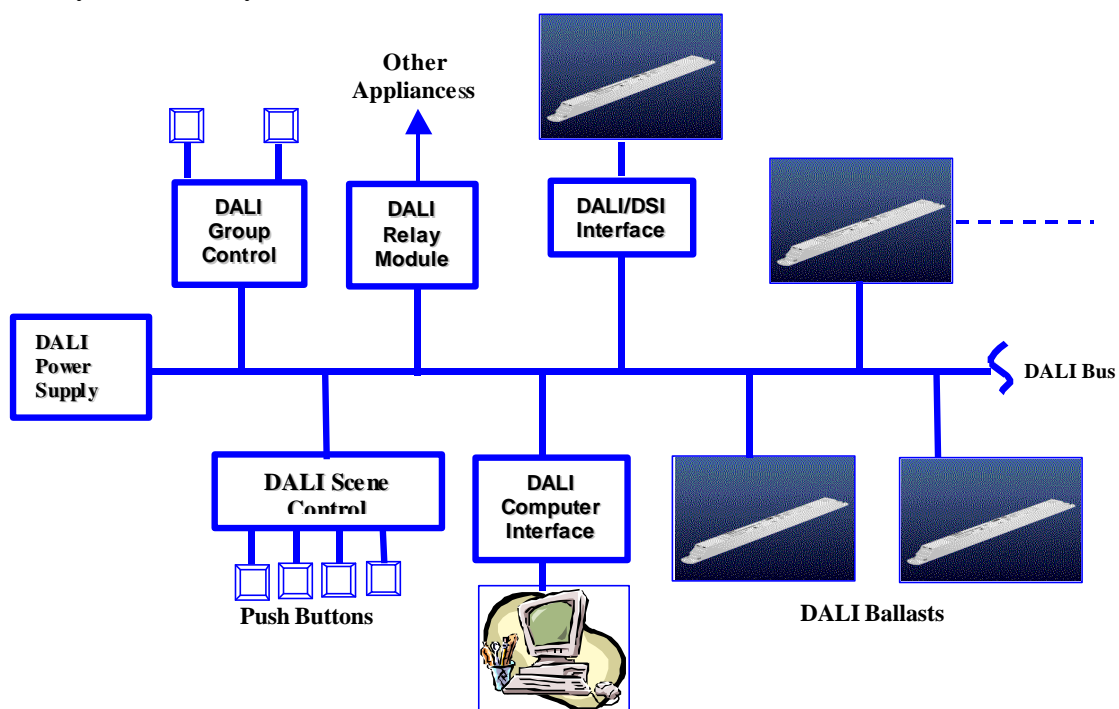

Fig. 6: A typical configuration of DALI control system

Fig. 6 shows a typical configuration of a DALI control system, which could also be used to control other related appliances, such as room AC systems, window blinds, projectors, projector screen, etc.

6. DALI CONTROL OF T5 LIGHTING AT KBIGH

According to CIBSE Lighting Guide 4 for Sports, indoor multi-purpose sport halls designed for badminton, basketball, volleyball, etc. shall be suitable for the following lighting classes:

- (a) Lighting Class I: Average horizontal illuminance of 750 lux for top-level competition and training at international and national standard.
- (b) Lighting Class II: Average horizontal illuminance of 500 lux for mid-level competition or high-level training at regional or local club level.
- (c) Lighting Class III: Average horizontal illuminance of 300 lux for low-level competition, general training, physical education and recreation activities, etc.

Basically, the whole games hall has been divided into eight lighting zones and each lighting zone could be controlled via individual DALI control signals as highlighted in Fig. 7. Each lighting zone represents one badminton court and consists of 20 nos. 2x80W T5 luminaires with a total nos. of 40 dimmable electronic ballasts. As these electronic ballasts acquire only a common digital signal for dimming, individual DALI ballasts are not required. An addressable DALI interfacing module together with an amplifier module have been allowed for each zone. Computer interfaces were installed in the manager office and the control station in the game hall for setting of lighting programmes. Other than the presetting scenic programmes for the three lighting classes I, II and III, each badminton court had also been set for individual operation. Different scene and group settings could simply be recalled by the push switches in the arena to suit various combinations of booking arrangements of the games hall. Fig.8 shows how the DALI system was being programmed on site via the computer interface in the control station.

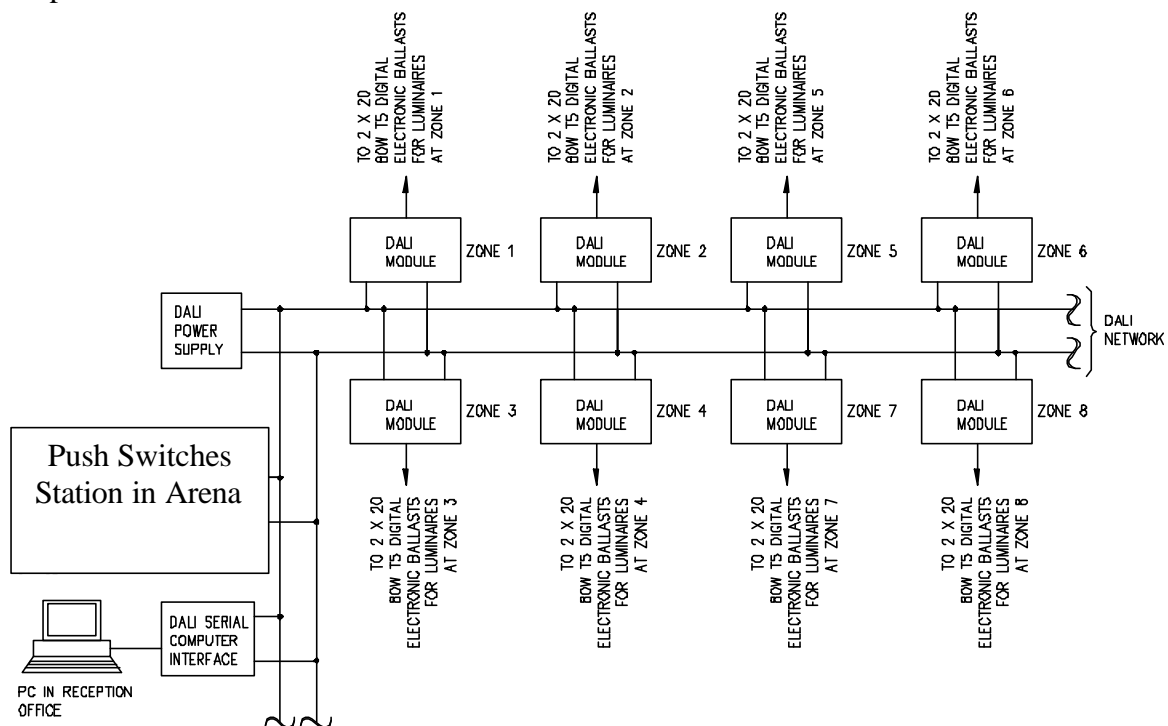

Fig. 7: DALI lighting control system for Kowloon Bay Indoor Games Hall



Fig. 8: Scene setting for the DALI lighting control system

7. ENERGY PERFORMANCE

Installation works of the new DALI T5 lighting system have been completed in March 2002. Measurements have been done on site for assessing its energy and visual performance. Fig. 9 and 10 highlight the differences in visual environment between the two lighting systems. Improvement is very obvious in terms of illuminance, colour temperature and colour rendering of the arena.



Fig. 9: Existing lighting environment with HID lamps in Kowloon Bay Indoor Games Hall



Fig.10: New lighting environment of the High Output T5 Lighting in Kowloon Bay Indoor Games Hall

Energy performance of the two lighting systems was measured on site in April 2002. The measured results were summarised in Table 1. It was found that the total power reduction for the new T5 lighting system at Lighting Class II was 11.5kW (46%) and improvement in current THD was also very apparent (reduced from 23.7% to 16.4%). As the games hall is fully air conditioning, reduction in heat gain from lighting would also decrease cooling load

of the AC plant. The estimate reduction in cooling load would be about 30% of the reduced lighting load (i.e. 3.5kW).

Table 1: Energy Performance of the Existing HID and New T5 Lighting Systems

	Existing HID Lighting System	New T5 Lighting System at Class II	% difference
Lighting Power (kW)	25 kW	13.5 kW	- 46%
Average Illuminance	473 lux	500 lux	+5.7%
Power Factor.	0.96	0.97	+ 1%
Current THD	23.74%	16.43%	- 30%
Annual Energy Consumption	146,000kWh	87,840kWh (Maximum)	- 46% (Minimum)

Fig. 11 and 12 below show the results of site measurements on the lighting distribution boards for the existing HID lighting system and the new T5 lighting system (set at Class II) with details of various electrical parameters. Other than improvement in energy saving, it is obvious by comparing the two current waveforms that T5 lighting system achieved less distortion and had less adverse effect in the power quality problems nowadays.

*Single Phase Readings - 04/04/02 11:20:15
Kowloon Bay Indoor Games Hall
Existing HID High Bay Lighting
Red Phase*

			Voltage	Current
Frequency	49.99 Hz	RMS	214.0 V	39.53 A
Power:		Peak	300.0 V	63.47 A
kW	8.14 kW	DC Offset	0.0 V	-0.15 A
kVA	8.46 kVA	Crest Factor	1.4	1.61
kvar	1.11 kvar	THD rms	1.99 %	23.74 %
Peak kW	17.49 kW	THD fund	1.99 %	24.44 %
Phase	8° lead	Hrms	4.3 V	9.38 A
Total PF	0.96	KFactor		2.35
DPF	0.99			

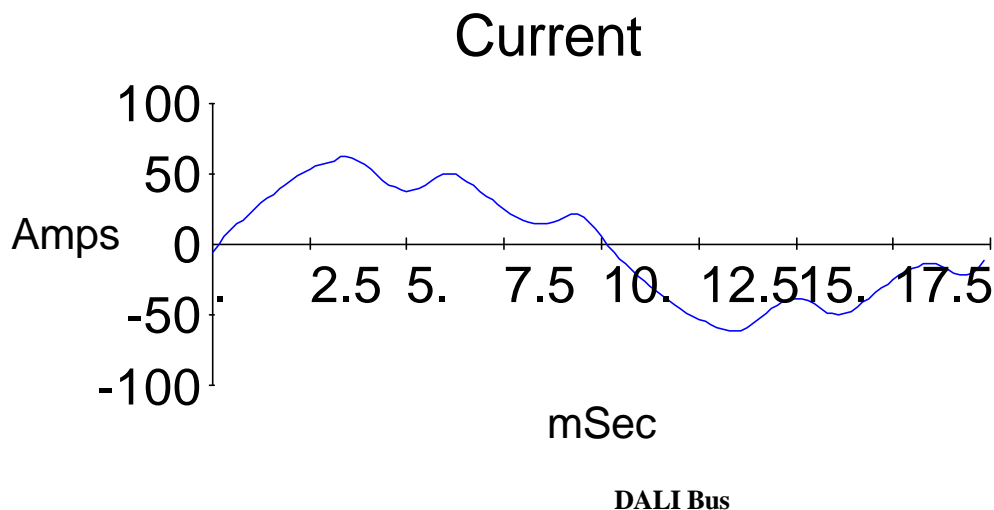

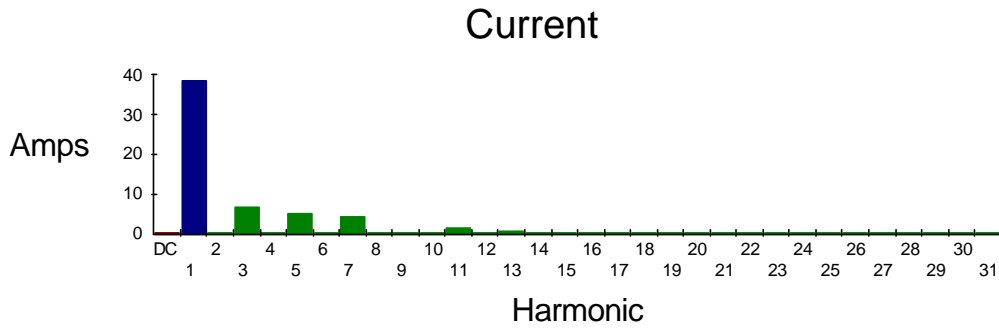

Fig. 11: Measurement on existing HID lighting circuits

Single Phase Readings - 04/04/02 11:29:09
 Kowloon Bay Indoor Games Hall
 New High Output T5 DALI Lighting System
 Red Phase (500 lux)

			Voltage	Current
Frequency	49.99 Hz	RMS	214.1 V	24.57 A
Power:		Peak	297.2 V	37.16 A
kW	5.08 kW	DC Offset	-0.1 V	-0.16 A
kVA	5.26 kVA	Crest Factor	1.39	1.51
kvar	1.07 kvar	THD rms	1.85 %	16.43 %
Peak kW	10.98 kW	THD fund	1.85 %	16.66 %
Phase	12° lead	Hrms	4.0 V	4.04 A
Total PF	0.97	KFactor		1.54
DPF	0.98			

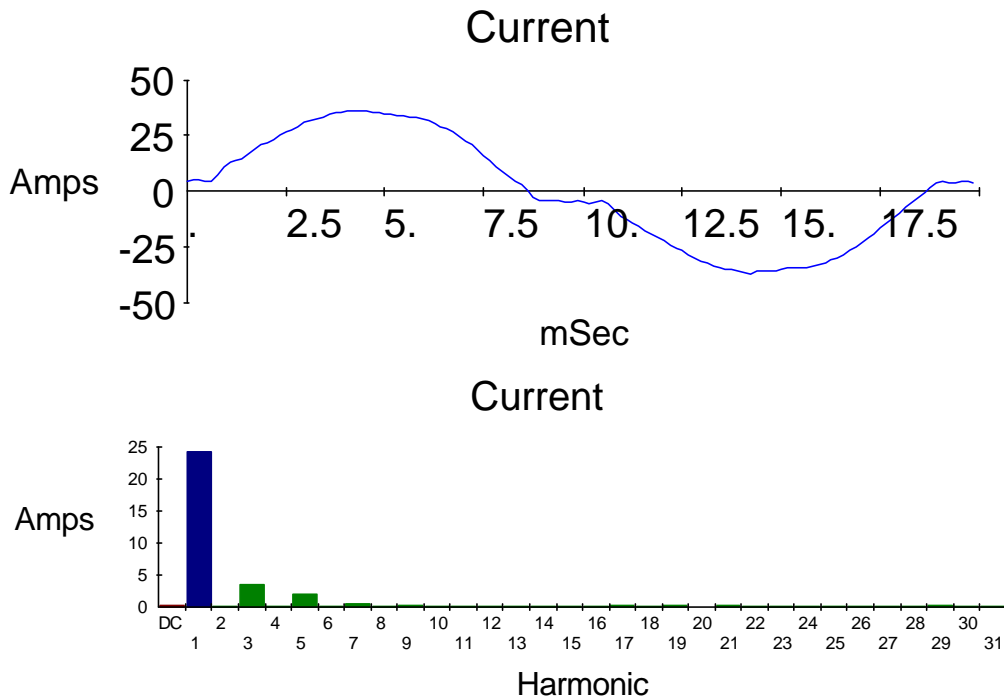

Fig. 12: Measurement on new HO T5 lighting circuits at Lighting Class II

8. SURVEYS ON USERS' FEEDBACK

In order to collect data on users' opinion of the new high output T5 lighting system in Kowloon Bay Indoor Games Hall, user surveys were conducted in the period between 16 May 2002 and 4 June 2002. A specially designed questionnaire was used in the survey. This questionnaire was faxed to the Kwun Tong District Leisure Services Office of the Leisure and Cultural Services Department for comments before it was used for the actual survey. The questionnaires were handed to the venue-in-charge of Kowloon Bay Indoor Games Hall on 16 May 2002. The questionnaires requested users of the games hall, who had experienced badminton playing under both lighting systems, to complete the questionnaires regarding their views of the two lighting systems. There were totally 30 returns collected on 4 June 2002. Results of the users' feedback were summarised in Fig. 13 and majority of the users involved in the surveys agreed that the new T5 lighting system was superior to the old HID lighting system in the aspects of brightness, comfort, glare, colour appearance and colour rendition. 68% of the users opined that they agree (strongly agree, agree or quite agree) to the statement "the overall lighting effect and environment is better than before".

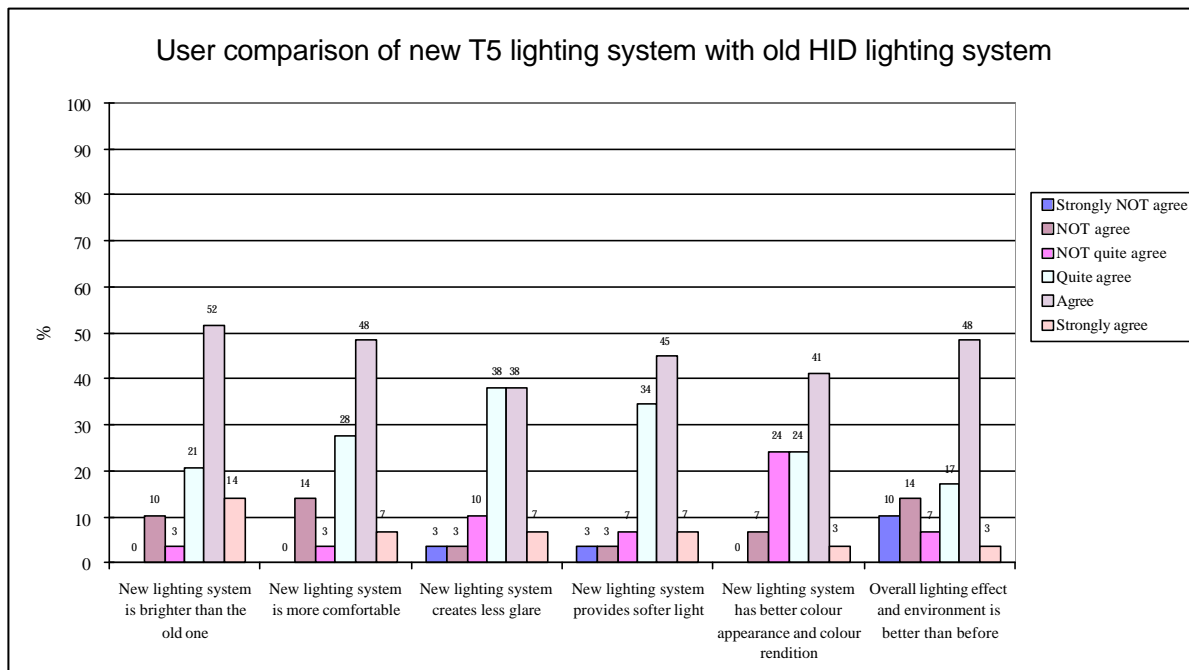

Fig. 13: Summary of user survey on the new T5 lighting system at KBIGH

9. CONCLUSION

The new T5 DALI lighting system has now been operating smoothly for more than a year. The management staff of KBIGH commented favourably on the new lighting system. They indicated that it offers a number of advantages – adjustable lighting level, ability to provide lighting to individual badminton courts, a more comfortable visual environment, and considerable savings in electricity expenditure.

Obviously, high bay lighting using high output T5 lamps and luminaires was proved to be more energy efficient and had better visual performance than HID lamps. We are optimistic that high output T5 lamps could replace conventional high bay lighting using HID lamps in the very near future in most application with high ceiling level including sport halls, warehouses, plant rooms, exhibition halls, etc.

Supplemented by the advance in digital lighting control system like DALI, the T5 lighting system could also be designed to suit various dimming and functional requirements in commercial buildings via Central Control and Monitoring Systems. Optimisation of energy consumption could also be achieved by automatic dimming and switching by local daylight and occupancy sensors. Wiring cost could be reduced as both power and control wirings to individual luminaire could be connected via multiple busbars to both LV lighting circuits and building control network. Each luminaire is individually addressed and programmed to its designated lighting group, scene and switch settings. Future modification in lighting arrangements could simply be made in a computer terminal.

REFERENCES

- [1] Wu, K.T., Chung T.M., HKIE Transactions. *High Bay Lighting Using High Output T5 Lighting*. Volume 10, Number 1, March 2003. Hong Kong: Hong Kong Institute of Engineers.
- [2] Wu, K.T., Lam K.K., HKIE Transactions. *Office Lighting Retrofit Using T5 Fluorescent Lamps & Electronic Ballasts*. Volume 10, Number 1, March 2003. Hong Kong: Hong Kong Institute of Engineers.
- [3] CIBSE (1990). *CIBSE Lighting Guide: Sports*. Lighting Guide LG4. London: Chartered Institution of Building Services Engineers.
- [4] IESNA (2000). *Lighting Handbook: Reference & Application*. 9th edition. New York: Illuminating Engineering Society of North America.
- [5] CIE (1983). *Lighting for sports halls*. CIE publication no. 58. Paris: Commission Internationale de L'Eclairage.
- [6] CIE (1992). *Maintenance of indoor electric lighting systems*. CIE Technical Report: CIE publication no. 97. Vienna: Commission Internationale de L'Eclairage.
- [7] EMSD (1998). *Code of Practice for Energy Efficiency of Lighting Installations*. Electrical and Mechanical Services Department, HKSAR Government.
- [8] EMSD (1998). *Code of Practice for Energy Efficiency of Electrical Installations*. Electrical and Mechanical Services Department, HKSAR Government.
- [9] Wu, K.T., Lee L.T., 1999, *Electronic Ballasts for Fluorescent Lamps*. Symposium on Tall Building and Construction Technology. Beijing 1999.