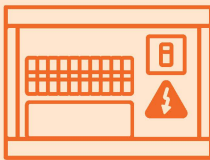
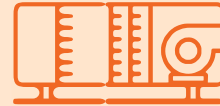
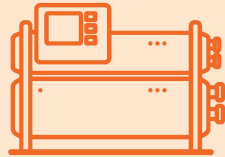


# Technical Guidelines on Code of Practice for Energy Efficiency of Building Services Installation



(back blank page of front cover)

## Technical Guidelines on Code of Practice for Energy Efficiency of Building Services Installation

<u>Table of Contents</u>	<u>Page No.</u>
1. Introduction	1
1.1 Ordinance (Cap 610) and Code of Practice (BEC clauses 1.1 & 1.2)	1
1.2 Technical Guidelines (TG-BEC 2021)	2
1.3 EMSD Web-site	2
1.4 Nomenclature	2
1.5 Minimum Standard of BEC	3
1.6 Effective Date of BEC 2021 and the Applicability of BEC 2018, BEC 2015, BEC 2012 (Rev. 1) and BEC 2012	3
1.7 Editions of the Technical Guidelines	3
2. Interpretations and Abbreviations	4
2.1 Interpretations (BEC clause 2.1)	4
2.2 Abbreviations (BEC clause 2.2)	6
3. Application	8
3.1 Scope of Application (BEC clause 3.1)	8
3.2 Limit of Scope of Application (BEC clause 3.2)	9
3.3 Examples of Non-applicable Building Services Installations	12
3.4 Determination of Application Threshold	13
4. Technical Compliance with the Ordinance	14
4.1 Control Regime (BEC clauses 4.1 & 4.2)	14
4.2 Demonstration of Compliance	16
4.2.1 Overall Process and Parties Involved	16
4.2.2 Declarations and Certificate of Compliance Registration	16
4.2.3 Form of Compliance for Major Retrofitting Works	19
4.2.4 Central Building Services Installation (CBSI)	20
4.2.5 Major Retrofitting Works	24
4.2.6 Non-major Retrofitting Works	27
4.2.7 Building Complex	27
4.3 Energy Efficiency Requirements at Design Conditions (BEC clause 4.3)	29
4.4 Requirements on Maintaining of Design Standard (BEC clause 4.4)	29
4.4.1 Duties of Owners and Responsible Persons	29
4.4.2 Applicable BEC Version	31
4.4.3 Illustrative Example on Applicable BEC Version	31
4.4.4 Repairs and Retrofits	34

<u>Table of Contents</u>	<u>Page No.</u>
4.4.5 Change of Use	35
4.5 Demonstration of Compliance Using Specified Forms and Technical Forms (BEC clause 4.5)	35
4.6 Responsible Person, Unit, Clubhouse & Carpark, and Residential Unit & Industrial Unit	37
4.6.1 Responsible Person	37
4.6.2 Unit	37
4.6.3 Clubhouse and Carpark	38
4.6.4 Residential Unit and Industrial Unit	39
4.7 Summary of Requirements	39
4.8 Other Legislative Provisions	40
5. Energy Efficiency Requirements for Lighting Installation	41
5.1 Scope of Application (BEC clause 5.1)	41
5.1.1 Comprehensive View on Applicability (BEC clause 5.1.1)	41
5.1.2 Examples of BEC Non-applicable Installations (BEC clause 5.1.2)	41
5.1.3 Lighting Serving Both as General Lighting and for Purpose Prescribed in Item 6 of Schedule 2 of the Ordinance	45
5.2 General Approach (BEC clause 5.2)	47
5.3 Definitions (BEC clause 5.3)	47
5.4 Lighting Power Density (LPD) (BEC clause 5.4)	48
5.4.1 Maximum Allowable LPD (BEC clause 5.4.1)	48
5.4.2 LPD of BEC Non-applicable Lighting Installations (BEC clause 5.4.2)	50
5.4.3 Separation Between Spaces (BEC clause 5.4.3)	50
5.4.4 Multi-functional Space (BEC Table 5.4)	51
5.5 Lighting Control Point (BEC clause 5.5)	51
5.5.1 Lighting Control Point (BEC clause 5.5.1)	51
5.5.2 Allowable Reduced Nos. of Lighting Control Points for Office (BEC clause 5.5.2)	53
5.5.3 Lighting Control Points for Multi-functional Space (BEC clause 5.5.3)	53
5.5.4 Separate Control for Ordinance-applicable Lighting and Ordinance Non-applicable Lighting (BEC clause 5.5.4)	53
5.5.5 Non-applicable lighting installation to the lighting control point requirement (BEC clause 5.5.5)	54
5.6 Automatic Lighting Control (BEC clause 5.6 and BEC Table 5.4)	54
5.6.1 Basic Provision	55
5.6.2 Daylight responsive control for daylight through fenestrations on exterior wall (BEC clause 5.6.2)	61
5.6.3 Daylight responsive control for daylight through overhead skylight (BEC clause 5.6.3)	64

<u>Table of Contents</u>	<u>Page No.</u>
5.7 Sample Calculation	64
6. Energy Efficiency Requirements for Air-conditioning Installation	67
6.1 Scope of Application (BEC clause 6.1)	67
6.1.1 Comprehensive View on Applicability (BEC clause 6.1.1)	67
6.1.2 Examples of BEC Applicable Installations (BEC clause 6.1.2)	67
6.1.3 Examples of BEC Non-applicable Installations (BEC clause 6.1.3)	68
6.2 General Approach (BEC clause 6.2)	68
6.3 Definitions (BEC clause 6.3)	68
6.4 System Load Calculation (BEC clause 6.4)	68
6.4.1 International Recognized Procedures (BEC clause 6.4.1)	68
6.4.2 System Load Design Conditions (BEC clause 6.4.2)	68
6.5 Separate Air Distribution System for Process Zone (BEC clause 6.5)	70
6.5.1 Example of Separate Air Distribution System (BEC clause 6.5.1)	70
6.5.2 Exemption from Requirement of Separate Air Distribution System (BEC clause 6.5.2)	70
6.6 Air Distribution Ductwork Leakage Limit (BEC clause 6.6)	71
6.7 Air Distribution System Fan Power (BEC clause 6.7)	72
(a) Maximum Allowable System Fan Motor Power (BEC clauses 6.7.1 to 6.7.3)	72
(b) Pressure Drop for Air Treatment or Filtering (BEC clause 6.7.3)	73
(c) Exemption from Maximum Allowable System Fan Motor Power Requirements (BEC clause 6.7.5)	75
(d) Vary of Airflow to System Load (BEC clause 6.7.4)	75
(e) Mechanical Ventilation System Fan Motor Power (BEC clause 6.7.6)	76
6.8 Pumping System Variable Flow (BEC clause 6.8)	79
6.8.1 Applicability (BEC clause 6.8.1)	79
6.8.2 Requirement for Variable Speed Pump (BEC clause 6.8.2)	80
6.8.3 Requirement on Chiller Isolation (BEC clause 6.8.3)	80
6.9 Frictional Loss of Water Piping System (BEC clause 6.9)	80
6.10 System Control (BEC clause 6.10)	81
6.10.1 Temperature Control (BEC clause 6.10.1)	81
6.10.2 Humidity Control (BEC clause 6.10.2)	82
6.10.3 Zone Control (BEC clause 6.10.3)	82
(a) Individual Control and On Same Floor (BEC clauses 6.10.3.1 & 6.10.3.2)	82
(b) Simultaneous Heating and Cooling (BEC clause 6.10.3.3)	83
6.10.4 Off-hours Control (BEC clause 6.10.4)	84

<u>Table of Contents</u>	<u>Page No.</u>
(a) General Approach for Off-hour Control (BEC clauses 6.10.4.1 & 6.10.4.2)	84
(b) Guest Rooms in Hotel, Guest House and Hostel (BEC clause 6.10.4.3)	85
(c) Automatic Shutoff Damper Controls (BEC clause 6.10.4.4)	85
6.10.5 Isolation of Zones (BEC clause 6.10.5)	86
(a) General Requirements	86
(b) Example Illustrating Isolation of Zones	87
(c) Exception on Isolation Devices and Controls (BEC clauses 6.10.5.3 (a), (b) and (c))	90
6.10.6 Control of VAV Air Distribution System (BEC clause 6.10.6)	91
6.10.7 Demand Control Ventilation (DCV) (BEC clause 6.10.7)	93
(a) DCV in Carpark (BEC clause 6.10.7.1 and 6.10.7.2)	93
(b) DCV in air-conditioned space (BEC clause 6.10.7.3 and 6.10.7.4)	93
6.11 Thermal Insulation (BEC clause 6.11)	97
6.11.1 Tabulated Insulation Thickness (BEC clause 6.11.1)	97
(a) General Requirements	97
(b) Heat Transfer Equations for Pipework	99
(c) Heat Transfer Equation for Ductwork	100
(d) Ambient Conditions	100
6.11.2 Insulation for Outdoor or Unconditioned Space (BEC clause 6.11.2)	100
6.12 Air-conditioning Equipment Efficiency (BEC clause 6.12)	100
6.12.1 Minimum Allowable Efficiency at Standard Rating Condition	100
6.12.2 Unitary Air-conditioner and Variable Refrigerant Flow (VRF) System	101
(a) Room Air-conditioner (BEC clause 6.12.2)	101
(b) Other Unitary Air-conditioner	102
(c) VRF System (BEC Table 6.12a (Part 2))	102
(d) Determination of COP (BEC Table 6.12a)	105
6.12.3 Chiller and Heat Pump (BEC Table 6.12b & Table 6.12c)	106
6.12.4 Requirement for Open-circuit Cooling Tower (BEC clause 6.12.4)	107
6.12.5 Cooling tower fan part load performance (BEC clause 6.12.5)	107
6.13 Energy Metering (BEC clause 6.13)	108
6.14 Direct Digital Control (DDC) (BEC clause 6.14)	111
(a) Direct Digital Control Configuration	111
(b) Direct Digital Control Requirements	112
6.15 Chilled Water Temperature Reset	113
7. Energy Efficiency Requirements for Electrical Installation	115

<u>Table of Contents</u>		<u>Page No.</u>
7.1	Scope of Application (BEC clause 7.1)	115
7.1.1	Comprehensive View on Applicability (BEC clause 7.1.1)	115
7.1.2	Examples of BEC Applicable Installations (BEC clause 7.1.2)	115
7.1.3	Examples of BEC Non-applicable Installations (BEC clause 7.1.3)	116
7.2	General Approach	117
7.3	Definitions	117
7.4	Power Distribution Loss	117
	(a) Distribution Transformer	117
	(b) Maximum Allowable Circuit Copper Loss	117
	i) General	117
	ii) Requirements for Different Types of Circuits	118
	iii) Sub-main Circuit (BEC clause 7.4.4)	119
	iv) Feeder Circuit (BEC clause 7.4.3)	121
	v) Final Circuit (BEC clause 7.4.5)	122
	vi) Effect of Power Factor & Harmonics (BEC clause 7.4.6)	122
	vii) Residential Buildings & Industrial Buildings Having a Common Area	122
	viii) Circuit under Responsibility of Two Parties	124
	ix) Power Source from another Existing Building	124
	(c) Guidelines on Calculation of Copper Loss	126
7.5	Motor Installation (BEC clause 7.5)	126
7.5.1	Motor Efficiency (BEC clause 7.5.1)	126
7.5.2	Motor Sizing (BEC clause 7.5.2)	127
7.5.3	Motors for Air-conditioning Equipment, for Fan of Distribution Transformer and for Lift & Escalator (BEC clause 7.5.3)	130
7.6	Power Quality (BEC clause 7.6)	130
	(a) General Requirements on TPF & THD (BEC clauses 7.6.1 and 7.6.2)	130
	i) Applicability	130
	ii) Demonstration of Compliance	130
	iii) Circuits Not Governed	131
	iv) Correction Devices OR Connection Points for the Devices	131
	v) Group Compensation of THD (BEC clause 7.6.2.4)	131
	vi) Circuits of Lifts & Escalators	131
	(b) Reactive Loads and Non-linear Loads	132
	(c) Connection Points for Correction Devices (BEC clauses 7.6.1 & 7.6.2)	135
	i) Circuits at or above 400 A (BEC clauses 7.6.1.2, 7.6.1.3, 7.6.2.2 & 7.6.2.3)	135
	ii) Three-phase Circuits Connecting to Electricity Suppliers' Meters (BEC clauses 7.6.1.1, 7.6.1.3, 7.6.2.1 and 7.6.2.3)	138

<u>Table of Contents</u>	<u>Page No.</u>
iii) Connection Points to be Shown in Drawings	139
(d) Residential Buildings & Industrial Buildings	142
(e) Electricity Supplier Requirements on TPF & THD	142
(f) Requirement on Balancing of Single-phase Loads (BEC clause 7.6.3)	142
7.7 Metering & Monitoring Facilities (BEC clause 7.7)	143
7.8 Guidelines on Calculation of Copper Loss	149
7.8.1 Conductor Resistance	149
7.8.2 Cable Sizing	150
7.8.2.1 Conventional Method	151
7.8.2.2 Power Factor and Losses due to Harmonic Distortion in Circuits with Non-linear Loads	151
7.8.3 Copper Loss Calculation	152
7.8.3.1 For a Three-phase Balanced & Linear Circuit	152
7.8.3.2 For a Three-phase Balanced Non-linear Circuit Having Known Harmonic Current	153
7.8.4 TPF & THD Inclusion in Copper Loss Calculation	155
7.9 Illustrative Example on Calculation of Copper Loss	155
8. Energy Efficiency Requirements for Lift and Escalator Installation	160
8.1 Scope of Application (BEC clause 8.1)	160
8.1.1 Comprehensive View on Applicability (BEC clause 8.1.1)	160
8.1.2 Examples of BEC Applicable Installations (BEC clause 8.1.2)	160
8.1.3 Examples of BEC Non-applicable Installations (BEC clause 8.1.3)	161
8.2 General Approach (BEC clause 8.2)	162
8.3 Definitions (BEC clause 8.3)	162
8.4 Electrical Power (BEC clause 8.4)	162
8.4.1 Traction Drive Lift (BEC clause 8.4.1)	162
8.4.1.1 Maximum Allowable Electrical Power (BEC clause 8.4.1.1 and BEC Table 8.4.1a & b)	162
8.4.1.2 Exemption from Maximum Allowable Electrical Power (BEC clause 8.4.1.2)	163
8.4.2 Hydraulic Lift (BEC clause 8.4.2 and BEC Table 8.4.2)	163
8.4.2.1 Maximum Allowable Electrical Power (BEC clause 8.4.2 and BEC Table 8.4.2)	163
8.4.3 Escalator (BEC clause 8.4.3 and BEC Table 8.4.3)	163
8.4.4 Passenger Conveyor (BEC clause 8.4.4 and BEC Table 8.4.4)	164
8.5 Utilization of Power (BEC clause 8.5)	165
8.5.1 Total Power Factor (BEC clause 8.5.1)	165
(a) General Requirements	165
(b) Motor DPF for Assessment of TPF for Escalator & Passenger Conveyor	166



<u>Table of Contents</u>		<u>Page No.</u>
8.5.2	Lift Decoration Load (BEC clause 8.5.2)	167
8.5.3	Lift Parking Mode (BEC clause 8.5.3)	168
8.5.4	Lift Ventilation & Air-conditioning (BEC clause 8.5.4)	168
8.5.5	Lift Regenerative Braking	170
8.5.6	Lift Car Automatic Lighting Control	170
8.5.7	Automatic Speed Reduction of Escalator (BEC clause 8.5.7)	171
8.6	Total Harmonic Distortion (BEC clause 8.6)	172
8.7	Metering & Monitoring Facilities	173
9.	Performance-based Approach	179
9.1	Scope of Application (BEC clause 9.1)	179
9.1.1	Comprehensive View on Applicability	179
9.2	General Approach (BEC clause 9.2)	179
9.3	Definitions (BEC clause 9.3)	181
9.4	Basic Requirements (BEC clause 9.4)	181
9.5	Comparison of Design Energy & Energy Budget (BEC clause 9.5)	181
9.6	Numerical Method for Building Energy Analysis (BEC Appendix A)	183
9.7	Simple Comparison between BEAM Plus energy model and performance-based model	185
9.8	Simple Case Study Example of Trade-off for Performance-based Approach	186
10.	Energy Efficiency Requirements for Major Retrofitting Works	189
10.1	Scope of Application (BEC clause 10.1)	189
10.1.1	Comprehensive View on Applicability and BEC Table 10.1	189
10.1.2	Textual Description of Checking Process in BEC Table 10.1	189
10.1.3	Flow Chart on Checking Process in BEC Table 10.1	191
10.1.4	Examples of Major Retrofitting Works by Virtue of Fulfilling the 500 m <sup>2</sup> Works Area Criterion	194
10.1.5	Examples of Major Retrofitting Works by Virtue of Fulfilling the Main CBSI Component Criterion	201
10.1.6	Major Retrofitting Works Fulfilling Both Works Area Criterion and Main CBSI Component Criterion	208
10.1.7	Same Series of Works in 12-month	208
10.1.8	Retrofitting Works Involving Luminaires Left Ready by Developer/Building Owner	213
10.1.9	Relocation of Luminaires	222
10.2	Performance-based Approach (BEC clause 10.2)	222
11	Emerging Good Engineering Practice	223
11.1	Lighting Installation	223

<u>Table of Contents</u>	<u>Page No.</u>
11.1.1 Addressable Lighting Control	223
11.2 Air-conditioning Installation	223
11.2.1 Fan Efficiency Grade (FEG)	223
11.2.2 Fan Energy Index (FEI)	225
11.2.3 High Efficiency Fan	226
11.2.4 Water Pump Efficiency	226
11.2.5 Installing Wet-bulb Air Temperature Sensors at Cooling Towers	227
11.2.6 Free Cooling	227
11.3 Electrical Installation	228
11.3.1 High Efficiency Motor	228
11.3.2 Separate Metering for Plug Load (Receptacle Load / Small Power Load)	230
11.4 Lift and Escalator Installation	231
11.4.1 Normalization & Monitoring of Lift Energy Consumption	231
11.4.2 Lift Traffic Management	232

(Blank page)

# 1 Introduction

## 1.1 Ordinance (Cap 610) and Code of Practice (BEC clauses 1.1 & 1.2)

Energy consumption in buildings is a key concern in the combat of climate change, and to improve the energy efficiency in buildings, the Buildings Energy Efficiency Ordinance (Cap 610) (hereinafter referred to as the Ordinance) was enacted in Nov 2010 and comes into full operation on 21 Sep 2012. The Ordinance applies to four key types of building services installations namely lighting installations, air-conditioning installations, electrical installations and lift and escalator installations. The Ordinance requires building services installations in prescribed buildings to comply with a code of practice issued by the Electrical and Mechanical Services Department (EMSD). In Feb 2012, EMSD issued the “Code of Practice for Energy Efficiency of Building Services Installation, 2012 Edition”, hereinafter referred as the “Building Energy Code 2012” or “BEC 2012”, which sets out the technical guidance and details in respect of the minimum energy efficiency requirements governing the building services installations under the Ordinance. An addendum, namely the Addendum No. BEC01 to the Code of Practice for Energy Efficiency of Building Services Installation, 2012 Edition, was published in end February 2014. The addendum covers primarily the tightening of energy efficiency requirements on lighting installation.

The first thorough review on the BEC 2012 was conducted since the third quarter of 2014. The new code, namely the “Code of Practice for Energy Efficiency of Building Services Installation, 2015 Edition” (hereinafter referred as the “Building Energy Code 2015” or “BEC 2015”), was gazetted on 11 December 2015.

After the second thorough review on the BEC 2015, the new edition of code, namely the “Code of Practice for Energy Efficiency of Building Services Installation, 2018 Edition” (hereinafter referred as the “Building Energy Code 2018” or “BEC 2018”), was gazetted on 16 November 2018.

The third thorough review on the BEC 2018, the new edition of code, namely the “Code of Practice for Energy Efficiency of Building Services Installation, 2021 Edition” (hereinafter referred as the “Building Energy Code 2021” or “BEC 2021”), was gazetted on 31 December 2021 to impose more stringent requirements on the technical aspects of energy efficiency requirements under the Ordinance.

The Ordinance also requires the carrying out of energy audit, for prescribed buildings in respect of their central building services installations, in accordance with the “Code of Practice for Building Energy Audit”, hereinafter referred as the “Energy Audit Code” or “EAC”, which was collectively issued with the BEC by EMSD. The new version of the code is the 2021 edition (known as the EAC 2021) was issued on the same day as the BEC 2021.

## 1.2 Technical Guidelines (TG-BEC 2021)

To assist in the understanding of the energy efficiency engineering requirements in the BEC against the legislative background of the Ordinance, EMSD in collaboration with various professional institutions, trade associations, academia and government departments issues technical guidelines correspondent to each Building Energy Code edition. This publication - the **“Technical Guidelines on Code of Practice for Energy Efficiency of Building Services Installation, 2021 Edition”**, in short **TG-BEC 2021**, is prepared as the supporting document for the BEC 2021. The TG-BEC 2021 provides an overview and certain explanations of the legislative requirements and the BEC 2021’s engineering requirements, with illustrative tables, diagrams and examples, and in particular detail descriptions on the declarations and forms issuance in the demonstration of compliance.

TG-BEC 2021 contains new discussions and elaboration on the technical requirement newly introduced under the BEC 2021. Updates and highlights are provided to address the tightened energy efficiency requirements. Further elaborations and clarifications are included in this publication on various issues addressing the trades’ concern and on enforcement related matters also.

For purpose of ready cross reference, the headings of the clauses in the TG-BEC 2021 have the relevant BEC 2021 clause numbers marked in brackets alongside.

Serving as guidelines to the BEC 2021 and being not a legislative document, the TG-BEC 2021 should not take precedence over the Ordinance or the BEC 2021 in respect of the interpretation of the intent and meaning of the requirements in the Ordinance and the BEC. Being a guidelines document, the TG-BEC 2021 also provides, in parallel to the basic understanding of the requirements of the BEC 2021, the good engineering practices for enhanced energy efficiency.

A separate technical guidelines document supplementing the EAC 2021 in respect of building energy audit is also issued, which is outside the scope of the TG-BEC 2021.

## 1.3 EMSD Web-site

To have a holistic view of the requirements of the Ordinance, readers of the TG-BEC 2021 are encouraged to study the Ordinance and the BEC 2021, which can be browsed at the web-site of the Ordinance (<https://www.emsd.gov.hk/beeo/>). The web-site provides a briefing on the Ordinance, the BEC and the EAC, along with the technical guidelines, and the necessary information updates. Attention is also drawn to the web-site’s FAQ web-page that gives answers to frequently asked questions about the Ordinance and the BEC.

## 1.4 Nomenclature

The BEC 2021 and TG-BEC 2021 are abbreviated as BEC and TG respectively in this

publication. When referring to a section, clause or table in the BEC, the section, clause or table would be prefixed with the designation BEC. The BEC 2021 appears in this TG when the discussion on applicability of different editions of the Building Energy Code involved.

### 1.5 Minimum Standard of BEC

The BEC requirements, which are the minimum energy efficiency standards under the Ordinance, are promulgated through the mandate. The BEC requirements should by no means be treated as the ultimate goal of energy efficiency. To enhance the energy efficiency of their buildings in the combat of climate change, building owners and registered energy assessor (REA)/designers are strongly encouraged to exceed these minimum standards in their building designs.

### 1.6 Effective Date of BEC 2021 and the Applicability of BEC 2018, BEC 2015, BEC 2012 (Rev. 1) and BEC 2012

Since launching the BEC 2021 on 31 December 2021, **six-month** and **nine-month** grace periods are applicable to the newly constructed buildings and the existing buildings respectively. The energy efficiency requirements as stipulated in the BEC 2021 apply to the building services installations (BSIs) covered in a Certificate of Compliance Registration (COCR) stage one declaration signed by the developer on or after 1 July 2022. Likewise, the same apply to the BSIs covered in a Form of Compliance (FOC) signed by the registered energy assessor on or after 1 October 2022.

During the grace periods, the BEC 2018 is acceptable in the COCR stage one declaration made and the FOC issued before the effective dates i.e. **1 July 2022** and **1 October 2022** respectively.

BEC 2012 are still applicable to any of the building issued with the COCR under the BEC 2012 and any of the unit or common area of a building where a FOC was issued under the BEC 2012. Likewise is applicable to the BEC 2012 (Rev. 1) edition, BEC 2015 edition and BEC 2018 edition.

### 1.7 Editions of the Technical Guidelines

The TG-BEC 2021 serves no purpose to replace the technical guidelines on previous BEC editions i.e. the TG-BEC 2012, TG-BEC 2012 (Rev. 1), TG-BEC 2015 and TG-BEC 2018 although the setup of this publication is similar to the TG-BEC 2012, TG-BEC 2015 and TG-BEC 2018. Instead, this publication is layout as a standalone document for readers' ease of understanding by avoiding cross referencing to previous editions of technical guidelines.

## 2 Interpretations and Abbreviations

### 2.1 Interpretations (BEC clause 2.1)

Section 2 of both the Ordinance and the BEC give the interpretations of terminologies adopted in the Ordinance and the BEC. These interpretations are also applicable to the TG. For ready reference, some of these interpretations are extracted (as shown in shaded boxes) below. The sections quoted in the extracts refer to the relevant sections in the Ordinance, unless otherwise stated.

'building services installation' means –

- (a) an air-conditioning installation;
- (b) an electrical installation;
- (c) a lift and escalator installation; or
- (d) a lighting installation;

#### TG Remarks to 'building services installation'

The interpretations of air-conditioning installation, electrical installation, lift and escalator installation and lighting installation are extracted in relevant Sections 5 to 8 in the TG.

'Certificate of Compliance Registration' means a Certificate of Compliance Registration issued under section 10 and, where applicable, renewed under section 13;

'commercial building' means a building that is –

- (a) used for offices, shops or entertainment facilities; or
- (b) used for the purpose of any trade, business or profession (but not used as an industrial building);

'common area', in relation to a prescribed building –

- (a) means any area of the building other than the parts that have been specified in an instrument registered in the Land Registry as being for the exclusive use, occupation or enjoyment of an owner; and;
- (b) includes, unless so specified, car parks, entrance lobbies, lift lobbies, corridors, staircases, common toilets, common store rooms, plant rooms, switch rooms, pipe ducts, cable ducts, refuse rooms, material recovery chambers, covered podia, covered playgrounds, occupants' clubhouses and building management offices;

'consent to the commencement of building works' means –

- (a) a consent given by the Building Authority under section 14 of the Buildings Ordinance (Cap 123); or

(b) an approval given in respect of a building not governed by that Ordinance which serves, in relation to that building, a purpose similar to that of the consent;

TG Remarks to 'consent to commencement of buildings works'

Pursuant to section 14 of the Buildings Ordinance (Cap 123), no person should carry out any building works without having first obtained from the Building Authority (a) his approval in writing of documents submitted to him; and (b) his consent in writing for the commencement of the building works. In respect of 'a consent to the commencement of building works for superstructure construction', it means the consent (known as the **first consent**) granted by the Building Authority on the application for commencement of building works made by the Architect in accordance with the previously submitted sets of approved plans made up of the general building plan, framing plans (the superstructure) and the drainage plans.

'developer', in relation to a building or a proposed building, means the owner of the land on which the building is built or will be built;

'Form of Compliance' means a Form of Compliance issued under section 17;

'occupation approval' means -

(a) an occupation permit; or

(b) an approval or a consent issued by a relevant authority to occupy a building for which no occupation permit is required under the Buildings Ordinance (Cap 123);

'occupation permit' – means an occupation permit or a temporary occupation permit issued under section 21(2) of the Buildings Ordinance (Cap 123);

'owner', in relation to a prescribed building, has the same meaning as in the Buildings Ordinance (Cap 123);

'registered energy assessor' means a person who is for the time being registered under section 30;

'responsible person', in relation to a building or a unit of a building, means a person who occupies or is in possession or control of the building or unit (whether under a lease or licence or otherwise);



'stage one declaration' means a declaration referred to in section 8(1);

'stage two declaration' means a declaration referred to in section 9(1);

'unit', in relation to a building, means –

(a) a unit or a part of the building; or

(b) 2 or more units or parts of the building that are -

(i) occupied by the same occupier for the purpose of the same undertaking, and

(ii) interconnected by an internal corridor, internal staircase or other internal access;

but does not include a common area of the building;

## 2.2 Abbreviations (BEC clause 2.2)

The abbreviations in BEC Section 2 are also applicable to the TG. In addition, the following abbreviations are used in the TG –

'AHU' refers to air handling unit

'ASHRAE' refers to American Society of Heating, Refrigerating and Air-Conditioning Engineers, Inc

'BEC 2012' refers to Building Energy Code, 2012 Edition or Code of Practice for Energy Efficiency of Building Services Installation, 2012 Edition issued on 10 February 2012

'BEC 2012 (Rev. 1)' refers to BEC 2012 with the Addendum No. BEC01 incorporated and issued on 28 February 2014

'BEC 2015' refers to Building Energy Code, 2015 Edition or Code of Practice for Energy Efficiency of Building Services Installation, 2015 Edition issued on 11 December 2015

'BEC 2018' refers to Building Energy Code, 2018 Edition or Code of Practice for Energy Efficiency of Building Services Installation, 2018 Edition issued on 16 November 2018

'BEC / BEC 2021' refers to Building Energy Code, 2021 Edition or Code of Practice for Energy Efficiency of Building Services Installation, 2021 Edition issued on 31 December 2021

'BMS' refers to building management system

'BSI' refers to building services installation

'CAV' refers to constant air volume

'CBSI' refers to central building services installation

- '**CIBSE**' refers to The Chartered Institution of Building Services Engineers (U.K.)
- '**COCR**' refers to Certificate of Compliance Registration
- '**COP**' refers to coefficient of performance (of chiller, heat pump or central chilled or heated water plant)
- '**DMC**' refers to deed of mutual covenant
- '**EAC**' refers to Energy Audit Code or Code of Practice for Building Energy Audit
- '**EMSD**' refers to Electrical and Mechanical Services Department
- '**FCU**' refers to fan coil unit
- '**FOC**' refers to form of compliance
- '**IESNA**' refers to Illuminating Engineering Society of North America
- '**MRW**' refers to the major retrofitting works as prescribed under the Ordinance
- '**OA**' refers to occupation approval
- '**O&M**' refers to operation and maintenance
- '**PAHU**' refers to primary air AHU (for pre-treated fresh air)
- '**REA**' refers to registered energy assessor
- '**TG-BEC 2012**' refers to the Technical Guidelines on Code of Practice for Energy Efficiency of Building Services Installation, 2012 Edition
- '**TG-BEC 2012 (Rev. 1)**' refers to TG-BEC 2012 with Addendum No. TG-BEC01 incorporated and issued on 28 February 2014.
- '**TG-BEC 2015**' refers to the Technical Guidelines on Code of Practice for Energy Efficiency of Building Services Installation, 2015 Edition
- '**TG-BEC 2018**' refers to the Technical Guidelines on Code of Practice for Energy Efficiency of Building Services Installation, 2018 Edition
- '**TG**' or '**TG-BEC 2021**' refers to the Technical Guidelines on Code of Practice for Energy Efficiency of Building Services Installation, 2021 Edition
- '**VAV**' refers to variable air volume

### 3 Application

#### 3.1 Scope of Application (BEC clause 3.1)

3.1.1 For a building belonging to one of the categories prescribed in Schedule 1 of the Ordinance, which is referred to as a prescribed building, the BEC is applicable to its building services installations. Schedule 1 covers most of the building categories commonly found in Hong Kong, including commercial buildings (such as office buildings and shopping malls), hotels, guesthouses, residential buildings, industrial buildings, composite buildings, education buildings, government buildings etc. For ready reference, Schedule 1 of the Ordinance is extracted in TG Table 3.1.1 below. The title of Schedule 1 draws reference to "Certificate of Compliance Registration" and "Form of Compliance", which play a prominent role in the compliance mechanism introduced in TG clauses 4.1 to 4.4.

<b><u>Table 3.1.1 : Extract of Schedule 1 of the Ordinance (Cap 610)</u></b>	
Schedule: 1	<b>BUILDINGS THAT REQUIRE CERTIFICATE OF COMPLIANCE REGISTRATION AND FORM OF COMPLIANCE</b>
	<ol style="list-style-type: none"> <li>1. Commercial building.</li> <li>2. A portion of a composite building that is not for residential or industrial use.</li> <li>3. Hotel and guesthouse.</li> <li>4. Common area of a residential building.</li> <li>5. Common area of a portion of a composite building that is for residential or industrial use.</li> <li>6. Common area of an industrial building.</li> <li>7. Building that is occupied principally for an education purpose.</li> <li>8. Building that is occupied principally as a community building including a community hall and social services centre and composite building occupied as 2 or more such places.</li> <li>9. Building that is occupied principally as a municipal services building including a market, cooked food centre, library, cultural centre and indoor games hall and composite building occupied as 2 or more such places.</li> <li>10. Building that is occupied principally for medical and health care services including a hospital, clinic and rehabilitation centre.</li> <li>11. Building that is owned by the Government and used principally for the accommodation of people during the performance of any function of the Government.</li> <li>12. Passenger terminal building of an airport.</li> <li>13. Railway station.</li> </ol>

- 3.1.2 For residential buildings, industrial buildings, commercial/residential composite buildings' residential portions, and commercial/industrial composite buildings' industrial portions, the BEC applies only to their common areas.
- 3.1.3 To identify if a building is a prescribed building, reference may be made to the usage categorization in its occupation approval issued by the Building Authority or in its instrument or land record maintained with the Land Registry or Lands Department (record in the form of land register, memorial, government lease, conditions of grant/sale/exchange etc.). Occupation approval is the reference for determining the usage of an existing building. Instrument(s) or document record from Land Registry may be used to identify the extent of common areas and hence the extent of the central building services installation inside the building. Record from Lands Department or condition of sale is the reference on the usage of a newly construction building, in particular, during the stage one declaration submission stage.
- 3.1.4 The scope of coverage of building services installations prescribed in the Ordinance pursuant to their interpretations under Section 2 of the Ordinance is confined to the four key types of installations of lighting, air-conditioning, electrical, and lift and escalator (their interpretations are also extracted in TG Section 2).
- 3.1.5 The applicability of the Ordinance is not dependent (pursuant to BEC clause 3.1) on the form or source of electrical supply to the building, irrespective of from the electricity supplier, from renewable energy, from on-site power generation etc.
- 3.2 Limit of Scope of Application (BEC clause 3.2)
- 3.2.1 The Ordinance has no retrospective effect on existing building services installations, which can remain at their existing levels of performances until they undergo major retrofits that fall within the scope of major retrofitting works. (defined in Schedule 3 of BEEO and pursuant to BEC Table 10.1)
- 3.2.2 Having prescribed in Schedule 1 the categories of buildings to which the Ordinance applies, it follows that the Ordinance does not apply to buildings not prescribed in Schedule 1, examples being a ventilation shaft building (for ventilating underground railway or cross-harbour tunnel), a power substation, a church, a standalone plantroom etc.
- 3.2.3 In respect of residential buildings, industrial buildings, commercial/residential composite buildings' residential portions, and commercial/industrial composite buildings' industrial portions, the BEC does not apply to areas that are outside the common areas, which are essentially their residential units or industrial units. By the same token, the BEC does not apply to these buildings or portions should they not have common areas (building with common area further described in TG clauses 4.2.4(a)).

3.2.4 (a) The Ordinance also prescribes in section 4 that it does not apply to -

- buildings of special types by small electrical supply, by restricted size, by historical nature, or by ceasing to exist;
- building services installations solely for specific purposes of fire suppression, surgical operation, usage in construction site, industrial manufacturing, research, air traffic safety, or railway traffic safety; or
- lighting installation solely for purpose of exhibit, decoration, or visual production.

(b) For ready reference, section 4 of the Ordinance (and Schedule 2 of the Ordinance) that prescribes the limit of scope of application is extracted in TG Table 3.2.4(b) below. Examples of building services installations to which the Ordinance does not apply, by virtue of fulfilling criteria prescribed in Schedule 2, are given in TG clauses 5.1.2 (lighting), 6.1.3 (air-conditioning), 7.1.3 (electrical) and 8.1.3 (lift & escalator).

**Table 3.2.4 (b) : Extract of Section 4 and Schedule 2 of the Ordinance (Cap 610)**

Section: 4 Limit of scope of application

(1) This Ordinance does not apply to -

- (a) a building of which the main electrical switch governing the electricity supply of the building has an approved loading not exceeding 100A, 1-phase or 3-phase;
- (b) a building -
  - (i) of not more than 3 storeys;
  - (ii) having a roofed-over area of not more than 65.03 m<sup>2</sup>; and
  - (iii) having a height of not more than 8.23 m;
- (c) a proposed monument or a proposed historical building declared under section 2A of the Antiquities and Monuments Ordinance (Cap 53); or
- (d) a monument or a historical building declared under section 3 of the Antiquities and Monuments Ordinance (Cap 53).

(2) This Ordinance does not apply to a building if the Director is satisfied on a declaration by the owner of the building that the building will cease to exist within 12 months after the date of the declaration.

(3) This Ordinance does not apply to the building services installations specified in Schedule 2.

Schedule: 2 BUILDING SERVICES INSTALLATIONS TO WHICH THIS  
ORDINANCE DOES NOT APPLY

1. An installation that is solely used for -
  - (a) fire suppression;
  - (b) fire extinguishing; or
  - (c) fire suppression and extinguishing.
2. An installation that is solely used for -
  - (a) surgical operation;
  - (b) clinical treatment;
  - (c) blood processing;
  - (d) providing or maintaining appropriate environment settings for life protection; or
  - (e) any combination of the purposes specified in paragraphs (a), (b), (c) and (d).
3. An installation that is used in a construction site for construction works only.
4. An installation that is solely used for industrial manufacturing.
5. An installation that is solely used for research in an educational institution.
6. A lighting installation that is solely used for -
  - (a) illumination of an exhibit or product on display including special lighting for illuminating merchandise or art work;
  - (b) decoration including special lighting for architectural feature or festival decoration effect;
  - (c) visual production including special lighting for performance, entertainment or television broadcasting; or
  - (d) any combination of the purposes specified in paragraphs (a), (b) and (c).
7. An installation that is solely used for -
  - (a) air traffic regulation;
  - (b) air traffic safety;
  - (c) air traffic control; or
  - (d) any combination of the purposes specified in paragraphs (a), (b) and (c).
8. An installation that is solely used for -
  - (a) railway traffic regulation;
  - (b) railway traffic safety;
  - (c) railway traffic control; or
  - (d) any combination of the purposes specified in paragraphs (a), (b) and (c).

(c) Small buildings (i.e. village houses, etc) with conditions comply with Section 4(1a & 1b) are not applicable to the Ordinance.

(d) The proposed and declared monument under Antiquities and Monument Ordinance Cap. 53 (<https://www.heritage.gov.hk/en/home/index.html>) which comply with Section 4(1c & 1d) are not applicable to the Ordinance.

3.2.5 The scope of coverage of building services installations prescribed in the Ordinance does not cover installations of fire services, security system, broadcast reception etc. which given them serving a building may sometimes also be regarded in the trade as under the scope of building services installation in a broad sense.

3.2.6 For buildings, with building services installations mentioned in Schedule 2, but still within the category of prescribed buildings in Schedule 1, the buildings are still under the governance of BEEO. The Schedule 2 only refer to part of the building services installations with special purposes that the Ordinance does not apply to.

### 3.3 Examples of Non-applicable Building Services Installations

Certain examples of building services installations to which the Ordinance does not apply are given in TG Table 3.3 below.

<b><u>Table 3.3 : Examples of Building Services Installations to which the Ordinance Does Not Apply</u></b>	
<u>Building services installation</u>	<u>Justification</u>
Fire service pump	A fire service installation, and thus not a building services installation under the Ordinance
Electrical circuit solely serving the above pump	Solely for fire suppression and extinguishing (item 1(c), Schedule 2 of Ordinance)
Smoke extract fan such as for basement (fan not for other use except for smoke extract)	Air movement equipment being part of a fire service installation not for normal operation. [Air-conditioning installation NOT within the scope of BEC clause 6.1.2 (a)]
Electrical circuit solely serving the above fan	Circuit fed by essential power supply and provides supply to equipment or installation which is NOT for routine normal operation. [Electrical installation NOT within the scope of BEC clause 7.1.2 (b)].
Remark: Further examples are also given in TG sections 5 to 8 according to the different categories of building services installations.	

### 3.4 Determination of Application Threshold

Attention is drawn to section 5 of the Ordinance, which is extracted in TG Table 3.4 below for ready reference. The rating of an installation, in the determination of application threshold, is the rating at works completion.

**Table 3.4 : Extract of Section 5 of the Ordinance (Cap 610)**

Section: 5 Determination of application threshold

If the applicability of any provision of this Ordinance is to be determined by reference to any threshold including the approved loading of a main electrical switch, the rating of an installation or the floor area of any place, the calculation or measurement must, unless otherwise prescribed, be made at the time when the relevant works have been completed.



## 4 Technical Compliance with the Ordinance

This section gives an overview of the process to demonstrate the compliance with the Ordinance. This section focuses on the legislative requirements prescribed in the Ordinance (mainly in Parts 2 and 3, covering sections 7 to 20), whereas the technical energy efficiency requirements of the BEC are explained in TG Sections 5 to 10.

### 4.1 Control Regime (BEC clauses 4.1 & 4.2)

4.1.1 The control regime draws reference on the date of the "consent to the commencement of building works" for superstructure construction. Buildings having the consent given on or before 21 Sep 2012 may be broadly referred to as existing buildings, and those having the consent given after 21 Sep 2012 the newly constructed buildings. In addition, based on the timing of the construction activities in buildings, the control regime also ties in with two distinct timeframes that are distinguished by the occupational approval or OA, the earlier timeframe being from design through building construction to OA issue, and the later timeframe being the post-OA routine building operation stage. For existing buildings, the control is mainly on the post-OA major retrofitting works. For newly constructed buildings, the control applies to both the earlier and later timeframes. The control regime is further described in TG Table 4.1.1 below.

<b>Table 4.1.1 : Control Regime (Parts 2 &amp; 3, Cap 610) Based on the Date of "Consent to the Commencement of Building Works" for Superstructure Construction<sup>@1</sup></b>		
	<u>Prescribed buildings with consent given after 21 Sep 2012<sup>@2</sup></u> (newly constructed buildings)	<u>Prescribed buildings with consent given on or before 21 Sep 2012<sup>@2</sup></u> (existing buildings)
<b>General</b>	The BEC is applicable to all building services installations in these buildings regardless of whether or not they are major retrofitting works <sup>@1</sup> .	The BEC is applicable to building services installations that are regarded as major retrofitting works in these buildings.
<b>At design stage through to occupation approval (OA)<sup>@1</sup></b>	In respect of the building services installations provided by the developer <sup>@3</sup> when a building is newly constructed, the building services installations in the building as at OA have to comply with the BEC requirements. The demonstration of compliance per TG clause 4.2.2 is required.	The BEC is not applicable.

Post-OA, i.e. during routine building operation	When major retrofitting works @ <sup>1</sup> are involved	In respect of the building services installations regarded as major retrofitting works (completed after OA), the building services installations have to comply with the BEC requirements. The demonstration of compliance per TG clause 4.2.3 is required.	In respect of the building services installations regarded as major retrofitting works completed on or after 21 Sep 2012, the building services installations have to comply with the BEC requirements. The demonstration of compliance per TG clause 4.2.3 is required.
	When non-major retrofitting works are involved	For building services installations not regarded as major retrofitting works (completed after OA), the building services installations still have to comply with the BEC requirements. However, the demonstration of compliance per TG clause 4.2.2/4.2.3 is NOT required.	The BEC is not applicable.
<p>Remarks:</p> <p>@<sup>1</sup> Interpretations of terminologies “consent to the commencement of buildings works”, “developer” and “OA” in the Ordinance are extracted in TG Section 2. Interpretation of “major retrofitting works” in the Ordinance is extracted in TG clause 4.2.5.</p> <p>@<sup>2</sup> 21 Sep 2012 - is the date of the full operation of the Ordinance.</p> <p>@<sup>3</sup> It is common that installations provided by the developer include the central building services installation (CBSI), which is further described in TG clause 4.2.4., including those involved building service installations at the full fit-out area under the scope of the developer (e.g. the club house or entrance lobby of a residential building).</p> <p>TG clause 4.4.3 addresses the compliance with the different editions of the BEC.</p>			

4.1.2 For the majority of private buildings, the “consent to the commencement of building works” is given by the Building Authority; for buildings not of the private sector, a consent carrying a similar effect in respect of permission to commence building works may be issued by the Architectural Services Department or by the Housing Department for buildings constructed by the respective Departments. When the building is ready for occupation, the Building Authority would issue an “occupation approval”, or “OA” in short, for buildings of the private sector; likewise the Architectural Services Department and the Housing Department would issue an OA carrying a similar effect in respect of permission to occupy a building for buildings under their purview.

4.2 Demonstration of Compliance

4.2.1 Overall Process and Parties Involved

Based on the control regime in TG Table 4.1.1, the process in the demonstration of prescribed buildings' compliance with the requirements of the Ordinance in respect of the fulfilling of the BEC requirements is described in TG clauses 4.2.2 and 4.2.3 below. The process includes the making of declarations, the issuing and obtaining of form and the obtaining of certificate (pursuant to Parts 2 and 3 (covering sections 7 to 20) of the Ordinance). The compliance process involves the developer, registered energy assessor (REA), owner and responsible person, who have their respective legal responsibilities under the Ordinance; the interpretations of these persons/parties are also given in TG Section 2. The process involves the forms 'stage one declaration', 'stage two declaration', 'Certificate of Compliance Registration (abbreviated as COCR)', and 'Form of Compliance (abbreviated as FOC)'; the interpretations of these terminologies are also extracted in TG Section 2.

<b>Table 4.2.1: Major Requirement for BEEO</b>				
	Responsible Party	Applicability	Code Compliance	Legal Obligation
Newly Constructed Building	Developer	4 key types of Building Services Installation	BEC (Full Compliance)	Apply for COCR
Existing Building	Responsible Person; Owner of Installation(s)	Major Retrofitting Works (MRW)	BEC (Partial and according to Table 10.1)	Obtain FOC (Endorsed by REA)

4.2.2 Declarations and Certificate of Compliance Registration

4.2.2.1 With reference to the control regime in TG Table 4.1.1, TG Table 4.2.2 below describes the compliance process at design stage through to OA for newly constructed buildings.

<b>Table 4.2.2 : Demonstration of Compliance with Ordinance (Part 2, Cap 610) – Building Services Installations Provided by Developer</b>
<p><b>Design stage through to OA - newly constructed buildings</b> (consent given after 21 Sep 2012)</p> <p>(a) For developer provided installations, typically including amongst others the building's <b>central building services installation (CBSI)</b> <sup>@2</sup> in <b>newly constructed</b></p>

**prescribed buildings -**

- i) the **developer** of the building, at the **design stage** of the building must :
    - make a **stage one declaration**<sup>@1</sup> (section 8(1) of Ordinance) and submit the declaration to EMSD, to declare that all the building services installations to be provided by the developer in the building (at or before the time when a stage two declaration is made) in respect of the building **are designed, and will be installed and completed**, in accordance with the BEC requirements;
    - in making the declaration engage a registered energy assessor (**REA**)<sup>@1 @3</sup> to certify the declaration to the effect that suitable **design provisions** have been incorporated into the planning and design of the building in accordance with the BEC requirements; and
    - the **stage one declaration** must be submitted **within 2 months** after the day on which the consent to the commencement of building works for the superstructure construction of the building is given; and
  - ii) the **developer** of the building, at the building's **OA stage** must :
    - make a **stage two declaration** <sup>@1</sup> and submit the declaration to EMSD, to declare that all the building services installations provided by the developer in the building at or before the time when the declaration is made **have been designed, installed and completed** in accordance with the BEC requirements;
    - in making the declaration engage an **REA** to certify the declaration to the effect that all the building services installations provided by the developer in the building at or before the time when the declaration is made **have been designed, installed and completed** in accordance with the BEC requirements; and
    - the **stage two declaration** must be submitted to EMSD **within 4 months**<sup>@4</sup> after the day on which the OA is issued in respect of the building.
- (b) The **REA** certifying the stage two declaration should have in the **30 days** before the certification **personally inspected** the building services installation covered by the certification.
- (c) The submission of stage one and stage two declarations have to be in the specified forms and be accompanied by the documents specified in the forms, and for stage two declaration the accompanying by the prescribed fee. The different forms and their usage are further described in TG clause 4.5 below.
- (d) EMSD would, based on the merit of the stage two declaration, issue the Certificate of Compliance Registration (**COCR**)<sup>@1</sup> within 3 months of receipt of the declaration. A COCR is valid for 10 years and has to be renewed. COCR is further explained in TG clauses 4.2.2.2 and 4.2.2.3.

Remarks:

- @1 Interpretations of terminologies 'stage one declaration', 'stage two declaration', 'REA', and 'COCR' in the Ordinance are extracted in TG Section 2.
- @2 Meaning of CBSI is further introduced in TG clause 4.2.4.
- @3 The REA is a role of professional engineers opened up in the Ordinance to assist the developers, owners or responsible persons to comply with the legislative requirements. The duty and registration of the REA is given in the Ordinance and the Buildings Energy Efficiency (Registered Energy Assessors) Regulation (Cap 610B) under the Ordinance. The certification of BEC compliance in declarations cannot be carried out by a person who is not an REA.
- @4 For any **works under the scope of the developer** not able to be completed within the four-month duration, the developer should make an application in writing for extending the stage two declaration submission period pursuant to section 9(5) of the Ordinance.

4.2.2.2 The COCR is a proof that the building services installations provided by the developer, typically including amongst others the central building services installation (CBSI), comply with the BEC requirements. CBSI is further discussed in TG clause 4.2.4. To obtain the COCR, the developer is to first submit the stage one declaration, which is to be followed by the stage two declaration. The stage one declaration serves simply as the developer's undertaking that he/she would cause the design and installation of the building services installation(s) he/she provides for the building to be in accordance with the BEC requirements. To signify the significance of the planning for BEC compliant design and installation in accordance with the compliant design, the declaration requires the certification by an REA. When the building is ready to be occupied by its occupiers and users, the authority will issue an OA, and it is time that the stage two declaration comes in, which requires the certification by an REA in respect of the erected building services installations' compliance with the BEC. EMSD would, based on the merit of the stage two declaration, issue the COCR. EMSD keeps a register of buildings issued with a COCR, and the register is available for public inspection.

#### 4.2.2.3 Renewal of COCR

Subsequent to the issue of the COCR, the owner(s) of the building (i.e. the Owners' Corporation or all owners, single owner etc.), every 10 years, is/are required to engage an REA:

- to certify that the design (not the condition of performance then) of all the four key types of CBSIs are maintained to a standard not lower than the BEC version applied in the first COCR of the building, and
- if a FOC has been issued for a certain CBSI, to certify that the design of installation is maintained to a standard not lower than the BEC version applied in the latest FOC issued in respect of the installation; and
- to submit application to EMSD for renewal of the COCR (application fee required).

4.2.2.4 Building Complex

There are building blocks that collectively form a building complex. TG clause 4.2.7 below introduces the building block concept that may be applicable to a building complex. The building block concept affects the numbers of declarations and COCRs in the demonstration of compliance.

4.2.3 Form of Compliance for Major Retrofitting Works

4.2.3.1 With reference to the control regime in TG Table 4.1.1, TG Table 4.2.3 below describes the compliance process during post-OA routine building operation for both newly constructed buildings and existing buildings. The meaning of major retrofitting works in the table is further discussed in TG clause 4.2.5.

<u>Table 4.2.3 : Demonstration of Compliance with Ordinance (Part 3, Cap 610) – Major Retrofitting Works</u>
<b>Post-OA routine building operation - both newly constructed buildings and existing buildings</b>
<p>(a) For both newly constructed buildings (consent given after 21 Sep 2012) and existing buildings (consent given on or before 21 Sep 2012),</p> <ul style="list-style-type: none"> <li>♦ if <b>major retrofitting works</b><sup>@1</sup> are carried out in respect of                             <ul style="list-style-type: none"> <li>- a building services installation that serves a <b>unit</b><sup>@1</sup>, the <b>responsible person</b><sup>@1</sup> of the unit, or</li> <li>- a building services installation that serves the common area of a building, the <b>owner</b><sup>@1</sup> of the <b>common area</b><sup>@1</sup>, or</li> <li>- a CBSI<sup>@2</sup>, the <b>owner</b><sup>@1</sup> of the installation</li> </ul>                             is required to                             <ul style="list-style-type: none"> <li>➔ engage an <b>REA</b><sup>@1 @3</sup> to personally inspect the major retrofitting works and certify in a <b>FOC</b><sup>@1</sup> that the works comply with the BEC requirements; and</li> <li>➔ obtain from the REA the FOC for the works <b>within 2 months</b> after work completion.</li> </ul> </li> </ul> <p>(b) The FOC has to be in the specified form and be accompanied by the documents specified in the form.</p> <p>(c) The REA must send a copy of the FOC to EMSD and the property management company of the building, and if there is no such company or the company cannot be found or ascertained to the owner of the building.</p> <p>(d) Unlike the COCR, both the accompanying fee (payable to EMSD) and renewal are not required.</p>

Remarks:

- @1 Interpretations of terminologies 'owner', 'responsible person', 'unit', 'common area', 'FOC' and 'major retrofitting works' in the Ordinance are extracted in TG Section 2. Meaning of 'major retrofitting works' is further introduced in TG clause 4.2.5.
- @2 Meaning of CBSI is further introduced in TG clause 4.2.4.
- @3 The REA is described in Remark@3 in TG Table 4.2.2. The certification of BEC compliance in FOC and its issuance cannot be carried out by a person who is not an REA. The interpretation of 'REA' is also given in TG Section 2.

4.2.3.2 The FOC is a proof that the building services installations categorized as major retrofitting works of the owner or responsible person comply with the BEC requirements.

#### 4.2.3.3 Completion of Major Retrofitting Works

Pursuant to section 17(3) of the Ordinance, the major retrofitting works are regarded as completed when all the building services installations involved in the works unless otherwise specified in TG clause 10.1.8(c) are ready to be used for the principal function as designed. For example, if lighting installation, electrical installation and air-conditioning installation are involved in the works and the air-conditioning installation is the last completed, the works are regarded as completed when the air-conditioning installation is also ready to be put into normal operation. A FOC should cover all the three installations involved in the major retrofitting works. Having a FOC for each of the installations is not acceptable. In practice, a certificate of completion issued by the works consultant or contractor, if available, may be regarded as documentary evidence illustrating the completion date of the works. The responsible person or the owner may assign the issuance of FOC for all the involved installations under the scope of an REA engaged by one of the installation contractors or the design consultant of the major retrofitting works.

#### 4.2.4 Central Building Services Installation (CBSI)

Given the building services installations provided by the developer typically cover the CBSI, and that the requirements on major retrofitting works for CBSI are different from those for non-CBSI, the differentiation of CBSI from the other building services installations would be helpful. For ready reference, the interpretation of CBSI in the Ordinance is extracted below.

'central building services installation' means –

- (a) a building services installation in a prescribed building that does not solely serve a unit of that building; or
- (b) a building services installation in a prescribed building that has no common area except an installation that -
  - (i) solely serves a unit of that building; and
  - (ii) is owned by a person who is not the owner of that building;

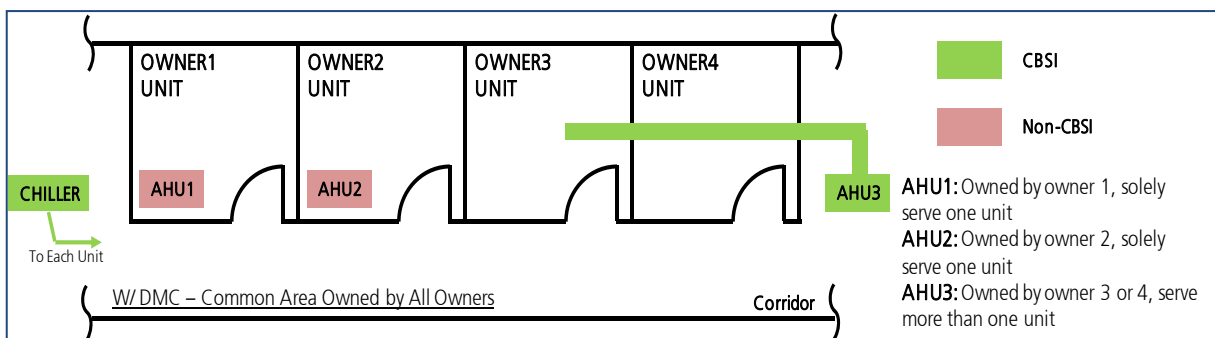
As prescribed in the Ordinance and with reference to the interpretation of CBSI above, there are buildings with common area and buildings that have no common area.

(a) Buildings with Common Area (with deed of mutual covenant)

A building with common area typically has a deed of mutual covenant (DMC) and has more than one building owners (interpreted in Building Management Ordinance, Cap 344), and its entrance lobby, common lift lobbies, common corridors, common staircases, common toilets, management offices etc. (that are not for the exclusive use of the respective units' owners) or "common area" are generally commonly used. In the other words, common area may be regarded as those areas jointly owned, or co-owned by the building owners. In such a type of building, there are typically a number of building services installations that are shared by several (or all) units in the building. These installations are also generally "commonly used" – such as lifts and escalators, central air-conditioning, etc.

Examples of CBSI and non-CBSI are given in TG Table 4.2.4 (a) below.

**Figure 4.2.4 (a) : Diagram indicating examples of CBSI and non-CBSI for a Building with Common Area**





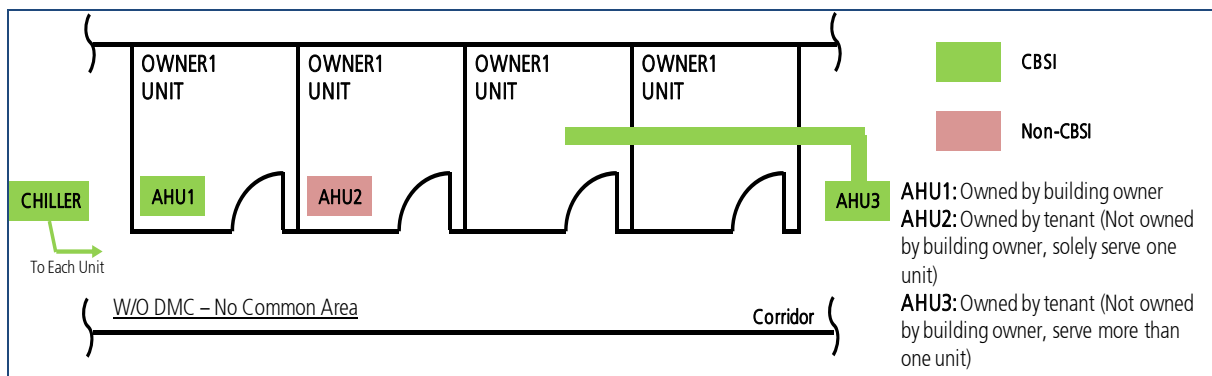
<b>Table 4.2.4 (a) : Examples of CBSI and non-CBSI for a Building with Common Area</b>				
<u>Commercial building (e.g. with office/shopping &amp; leisure units) with common area</u>				
Consider a commercial building with DMC and having office and/or shopping & leisure units, and some of the units have been specified in instrument(s) registered in the Land Registry as for the exclusive use of the respective owners. The building may have units leased to tenants. Areas such as entrance lobby, common lift lobbies, common corridors, common staircases, common toilets etc. (that are not for the exclusive use of the respective units' owners) in the building are typically referred to as the common area of the building.				
	<b>Lighting installation</b>	<b>Air- conditioning installation</b>	<b>Electrical installation</b>	<b>Lift and escalator installation</b>
<b>Examples of CBSI</b>	Luminaires in the common area	Central chilled/heated water plant (for air-conditioning); AHU serving two or more units	Main LV switchboard and rising mains	Lift serving common lift lobbies
<b>Examples of non-CBSI</b>	Luminaires in a unit that is leased or separately owned	AHU solely serving a unit that is leased or separately owned	Circuit on the outgoing side of electricity supplier's electricity meter for a unit	Escalator within and solely serving a department store (a unit)

(b) Buildings without Common Area (without DMC)

A building without common area typically has no DMC. In an even simpler term, this may mean a single-owned building where the sole owner has no area within the building co-owns with others.

Examples of CBSI and non-CBSI for a building having units leased to tenants are given in TG Table 4.2.4 (b) below.

**Figure 4.2.4 (b) : Diagram indicating examples of CBSI and non-CBSI for a Building without Common Area**



<b><u>Table 4.2.4 (b) : Examples of CBSI and non-CBSI for a Building Without Common Area and Having Units Leased to Tenants</u></b>				
<u>Commercial building (e.g. with office/shopping &amp; leisure units) without common area</u>				
Consider a commercial building without DMC and having office and/or shopping & leisure units; there are units leased to tenants and each of these units has not been specified in an instrument registered in the Land Registry as for the exclusive use of a unit owner. The building is under a single ownership, and may be regarded as one without common area.				
	<b>Lighting installation</b>	<b>Air- conditioning installation</b>	<b>Electrical installation</b>	<b>Lift and escalator installation</b>
<b>Examples of CBSI</b>	Luminaires in main entrance, common lift lobbies, common staircases etc.; Luminaires in a unit that is not leased; Luminaires owned by the building owner in a leased unit	Central chilled/heated water plant (for air-conditioning); AHU serving a unit that is not leased; AHU owned by the building owner and serving a leased unit	Main LV switchboard and rising mains; Circuit with supply on account of the building owner	Lift serving the common lift lobbies
<b>Examples of non-CBSI</b>	Luminaires in a unit leased to a tenant who owns the luminaires	AHU solely serving a unit leased to a tenant who owns the AHU	Circuit on the outgoing side of electricity supplier's electricity meter for a unit that is leased to a tenant who owns the circuit	Escalator within and solely serving a department store (a unit) that is leased to a tenant who owns the escalator

Consider a commercial building without common area, i.e. without units that have been specified in instrument(s) registered in the Land Registry as for the exclusive use of an owner, and having no areas leased to tenants. All the building services installations (under the Ordinance) in the building are regarded as CBSI. A typical example is the headquarter building of an international enterprise or the administration building of an education campus.

(c) CBSI in Commercial Portion of Composite Building

Having provided the principles to differentiate between CBSI and non-CBSI in items (a) & (b) above for a commercial building, the same principles apply to the commercial portion of a composite building.

- (d) Although discussion on CBSI is made reference to commercial building throughout the previous paragraphs, it should be stressed that the concept of CBSI is also applicable to each of the prescribed building type under Schedule 1 of the Ordinance.
- (e) The classification of CBSI and non-CBSI directly related to the definition of MRW. Addition or replacement of a main component of a CBSI may be defined as MRW in accordance to BEC Table 10.1 item (b).
- (f) The CBSI should be maintained to a standard not lower than that applied in the first COCR issued in respect of the building for COCR renewal in accordance to BEE0 Section 13 item (2)(c)(i).

#### 4.2.5 Major Retrofitting Works

Pursuant to Schedule 3 of the Ordinance, works for building services installations are regarded as major retrofitting works either by virtue of having involved a works area of not less than 500 m<sup>2</sup> or having involved a main component of a CBSI. For ready reference, Schedule 3 of the Ordinance is extracted in TG Table 4.2.5 below.

<b>Table 4.2.5 : Extract of Major Retrofitting Works in the Ordinance</b>	
‘major retrofitting works’ means the works specified in Schedule 3 –	
<u>Extract of Schedule 3 of the Ordinance (Cap 610)</u>	
Schedule: 3	<p style="text-align: center;"><b>MAJOR RETROFITTING WORKS</b></p> <ol style="list-style-type: none"> <li>1. Works involving addition or replacement of a building services installation specified in a code of practice that covers one or more places with a floor area or total floor area of not less than 500 m<sup>2</sup> under the same series of works within 12 months in a unit or a common area of a prescribed building.</li> <li>2. Addition or replacement of a main component of a central building services installation, including -               <ol style="list-style-type: none"> <li>(a) addition or replacement of a complete electrical circuit at rating of 400A or above;</li> <li>(b) addition or replacement of a unitary air-conditioner or air-conditioning chiller of a cooling or heating rating at or exceeding 350 kW; or</li> <li>(c) addition or replacement of the motor drive and mechanical drive of a lift, an escalator or a passenger conveyer.</li> </ol> </li> </ol>

<p><b>Notes</b></p> <p>(1) For the purposes of item 1 of this Schedule -</p> <p style="padding-left: 40px;">(a) an occupants' clubhouse or a car park is to be regarded as a separate common area within the building; and</p> <p style="padding-left: 40px;">(b) all other common areas are to be regarded together as a separate common area.</p> <p>(2) If works are carried out for more than one place in a unit or a common area of a prescribed building and, having regard to all relevant factors of the case, the works should reasonably be regarded as being under the same series of works, the reference to floor area in item 1 of this Schedule is a reference to the aggregate of the floor area of all those places.</p> <p>(3) In Note (2), "relevant factors" means -</p> <p style="padding-left: 40px;">(a) whether the works are carried out by a single contractor;</p> <p style="padding-left: 40px;">(b) whether the works are carried out under a single agreement;</p> <p style="padding-left: 40px;">(c) whether the works are carried out pursuant to a single works order;</p> <p style="padding-left: 40px;">(d) the time at which and the period during which the works are carried out;</p> <p style="padding-left: 40px;">(e) the manner in which the contractor is paid; and</p> <p style="padding-left: 40px;">(f) whether the works are treated as a single project in the plans and works programme.</p>
--

#### 4.2.5.1 500 m<sup>2</sup> Works Area Criterion

(a) The 500 m<sup>2</sup> in item 1 of Schedule 3 refers to the internal floor area of the works area; according to the interpretation in BEC Section 2 internal floor area means the floor area of all enclosed spaces measured to the internal faces of enclosing external and/or party walls. Noteworthy the works area may not be the area served by the concerned building services installations. In practice, such works area may be identified on the relevant layout plans and/or by the actual separation (using hoarding, canvassing, fencing or signage etc.) of the works area on site from the surrounding non-works area.

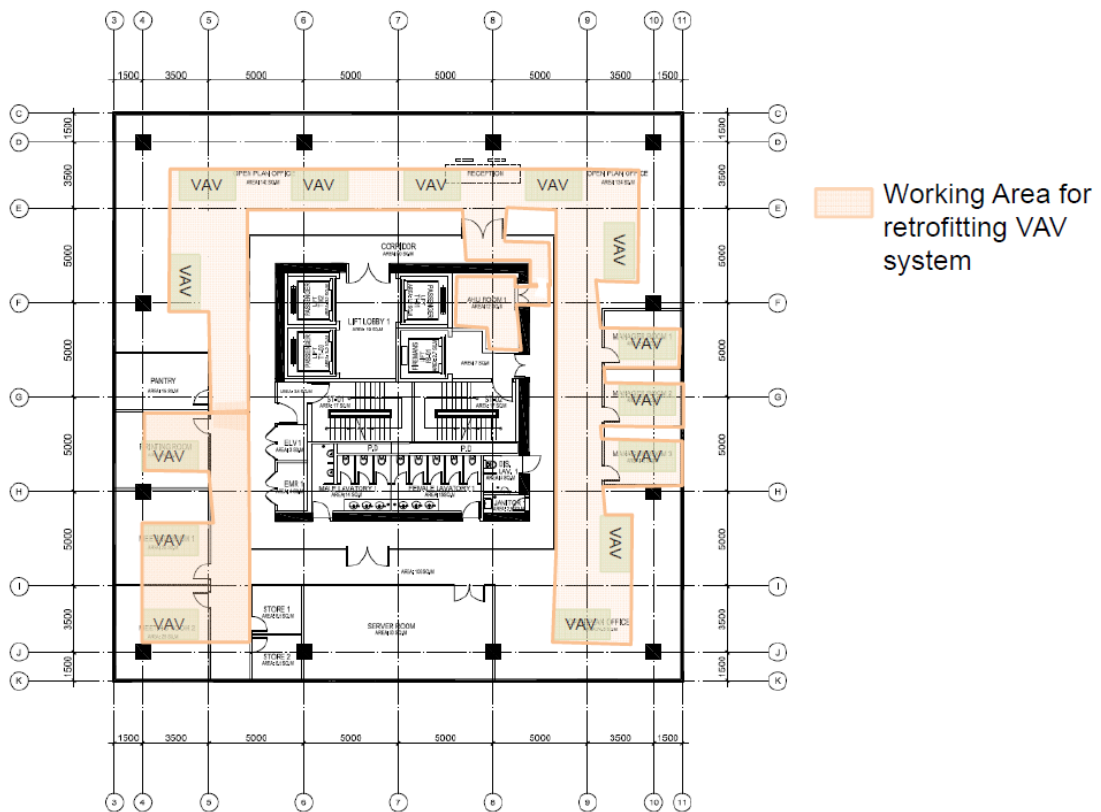
As an indication of what constitute the works area, take for example the retrofitting of a VAV system shown in TG Figure 4.2.5.1 below, which includes -

- AHU plant room area
- Supply and return air ductwork routing area
- VAV box replacement areas, and
- Other electrical work areas (cabling etc. in associated with the retrofitting of the VAV system)

If the works area is 500 m<sup>2</sup> or more, the works would be regarded as major retrofitting works.

(b) For the purpose of counting the 500 m<sup>2</sup> works areas, all the works conducted at the various places within a unit or a common area are considered under **the same series of works** if the works are treated as a single project in the plans and works programme even though those works are carried out by different contractors being assigned under different agreements and paid under different works order.

**Figure 4.2.5.1: Works area for retrofitting VAV system**



#### 4.2.5.2 CBSI Main Component Criterion

Other than the 500 m<sup>2</sup> criterion, works may also be regarded as major retrofitting works by virtue of the works being an addition or replacement of a main component of a CBSI. In determining the rating of an installation or the floor area of any place leading to the composition of the relevant CBSI, the calculation or measurement, as so described in TG clause 3.4, should be made at the time when the relevant works have been completed.

#### 4.2.5.3 BEC Section 10

BEC Section 10 provides the guidelines on major retrofitting works, which are further elaborated in TG Section 10.

#### 4.2.6 Non-major Retrofitting Works

For works not regarded as major retrofitting works, the above demonstration of compliance is not required.

In newly constructed buildings issued with a COCR to BEC 2012, for instance, the building services installations of such non-major retrofitting works are however required to comply with the BEC 2012 (also refer TG clause 4.4.3). Although demonstration of compliance is not required, as a good engineering practice proper records may be maintained to indicate the compliance.

In existing buildings, non-major retrofitting works are not governed by the BEC, the compliance of which is nevertheless strongly encouraged.

A copy of FOC, if identified as covering a non-major retrofitting works and submitted to the EMSD, the submitted materials are filed while the submission record is not registered on the website of the Ordinance. This is based on the understanding that the EMSD has no legal right to process any works/submission not governed under the Ordinance or the BEC.

#### 4.2.7 Building Complex

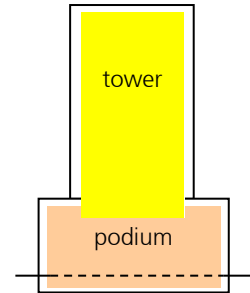
A building complex may contain several physical blocks, and each block may be issued a separate OA based on the different phased completions of the blocks in the complex, or based on their different ownership or management. The following gives the guidelines on the composition of an entity for the making of an individual declaration and obtaining of a COCR.

The terms podium and tower hereinafter mentioned refer to common configuration of large commercial buildings in Hong Kong, where the podium and the tower serve different major usages. It is common that the podium is comprised of the lower floors near ground level, and covers areas for shopping & leisure usage, such as a shopping mall having retail units, restaurants, cinemas, health centres etc., with or without car park, atrium or basement, together with CBSI major plant rooms and utility plant rooms, and it is common that the vertical transportation in the podium relies more on escalators than lifts. On the other hand, the tower is comprised of the floors above the podium, has vertical transportation usually relying more on lifts, and typically has floors each with smaller area than a podium floor; while office work is a common major usage of the tower there are also towers for residential units, hotel, shopping & leisure etc.

4.2.7.1 COCR Per Podium Tower Pair

For a building complex consisting of a podium block and a single tower block, as shown in TG Figure 4.2.7.1, the complex is normally regarded as a single building block requiring a single COCR and thus single stage one and stage two declarations.

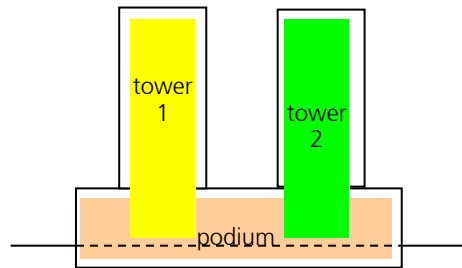
**Figure 4.2.7.1 : Building complex with a podium and a tower counted as a single block**



4.2.7.2 COCR Per Building Block

For a building complex consisting of three blocks, namely tower 1, tower 2 and podium, as shown in TG Figure 4.2.7.2, a COCR should be obtained for each building block, namely for podium block, tower 1 block and tower 2 block, that is a total of 3 nos. COCRs, with separate stage one declarations and stage two declarations.

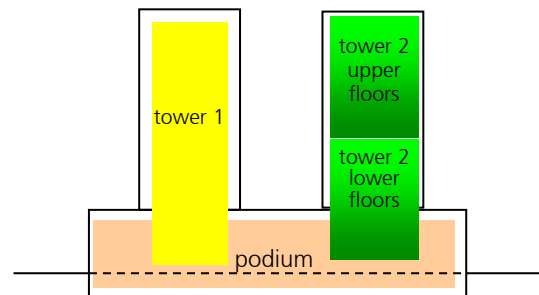
**Figure 4.2.7.2 : Two towers with common podium counted as 3 nos. building blocks**



Likewise for a building complex with a podium and three towers a total of 4 nos. COCRs should be obtained, a podium and four towers a total of 5 nos. COCRs, and so on.

4.2.7.3 Consider a building complex in TG Figure 4.2.7.3, which is similar to TG Figure 4.2.7.2, but this time tower 2 has different OAs respectively for its upper floors and lower floors. Now there are 4 nos. blocks, namely podium block, tower 1 block, tower 2 lower floors block and tower 2 upper floors block, and it is required to obtain for each of

**Figure 4.2.7.3 : Building complex with different blocks and phased completion**

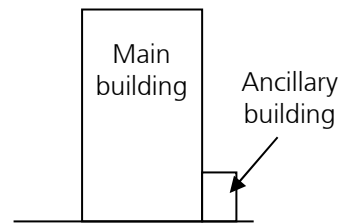


these 4 blocks a separate COCR, that is a total of 4 nos. COCRs for the complex, with separate stage one declarations and stage two declarations. Attention is drawn that the interpretation of OA covers also a temporary occupation permit.

#### 4.2.7.4 Ancillary Building

An annexed ancillary building shown in TG Figure 4.2.7.4 may be considered as a portion of the main building, subject to both being occupied at the same time and issued the same single OA.

**Figure 4.2.7.4 : Main building and annexed ancillary building**



#### 4.2.7.5 Renewal of COCR for Grouping of Building Blocks under a Single COCR

For purpose of management convenience, the owner of a building complex consisting of different blocks with different COCRs may wish to group them under a single COCR. The grouping may be made through a REA-certified renewal that is prescribed in section 13 of the Ordinance. The owner may renew the block COCRs at the same time and request EMSD to issue a single COCR covering all the developer provided building services installations under the different stage two declarations. Needless to say the maintaining of design standard as described in TG clause 4.4 is to be certified by the REA in the renewal.

Section 13 of the Ordinance offers the provision for COCR renewal, both for purpose of the above COCR grouping, as well as for the renewal upon COCR expiry described in TG clause 4.2.2.3.

### 4.3 Energy Efficiency Requirements at Design Conditions (BEC clause 4.3)

The energy efficiency requirements in the BEC refer to the performance standards at the corresponding design conditions, and not at the operating conditions which may deviate from time to time from the design conditions. An example is a chiller's COP is governed by BEC Table 6.12b at the standard rating condition in the table which represents the design condition, and the chiller would likely not operate at the rated COP under actual operating conditions that deviate from the standard rating condition.

### 4.4 Requirements on Maintaining of Design Standard (BEC clause 4.4)

#### 4.4.1 Duties of Owners and Responsible Persons

The duties of owners and responsible persons given in sections 12(3), 12(4) and 18(2) of the Ordinance (where section 12 and 18 refer to matters about COCR and FOC respectively) to maintain their building services installations to the relevant design standard are extracted in TG Table 4.4.1 below.



**Table 4.4.1 : Extracts of sections 12(3), 12(4) and 18(2) of the Ordinance on Maintaining of Design Standard (Cap 610)**

**12. Duties of owners and responsible persons of building with Certificate of Compliance Registration**

- .....
- (3) The owner of a building must ensure that -
    - (a) the central building services installations in the building are maintained to a standard not lower than that applied in the first Certificate of Compliance Registration issued in respect of the building; and
    - (b) if a Form of Compliance has been issued in respect of any central building services installation in the building, the installation is maintained to a standard not lower than that applied in the latest Form of Compliance issued in respect of the installation.
  - (4) The responsible person of a unit of a building must ensure that –
    - (a) the building services installations serving the unit that are not the central building services installations in the building meet, and are maintained to, a standard not lower than that applied in the first Certificate of Compliance Registration issued in respect of the building; and
    - (b) if a Form of Compliance has been issued in respect of any building services installation serving the unit, the installation is maintained to a standard not lower than that applied in the latest Form of Compliance issued in respect of the installation.
- .....

**18. Requirements applicable to Form of Compliance**

- .....
- (2) If a Form of Compliance is issued in respect of any building services installation, the responsible person of the relevant unit or the owner of the relevant common area of the building or, in the case of a central building services installation, the owner of the installation must maintain the installation to a standard not lower than that applied in that Form of Compliance.

The maintaining of standard refers to the maintaining of the design standard of the applicable BEC version. The maintaining of standard does not refer to the maintaining of operating conditions such as optimizing room temperature, chilled water temperature, and lighting level, and cleaning of equipment such as coil surface and filter etc., which are good engineering practices but not the legislative requirements under the Ordinance.

#### 4.4.2 Applicable BEC Version

The standard applied in the COCR refers to the design standard of the applicable BEC version, and the standard applied in the FOC refers likewise to the design standard of the applicable BEC version.

#### 4.4.3 Illustrative Example on Applicable BEC Version

TG Figure 4.4.3 illustrates the applicability of different versions of the BEC to a typical office building as an example. The time bars illustrate the effective dates of the BEC editions:

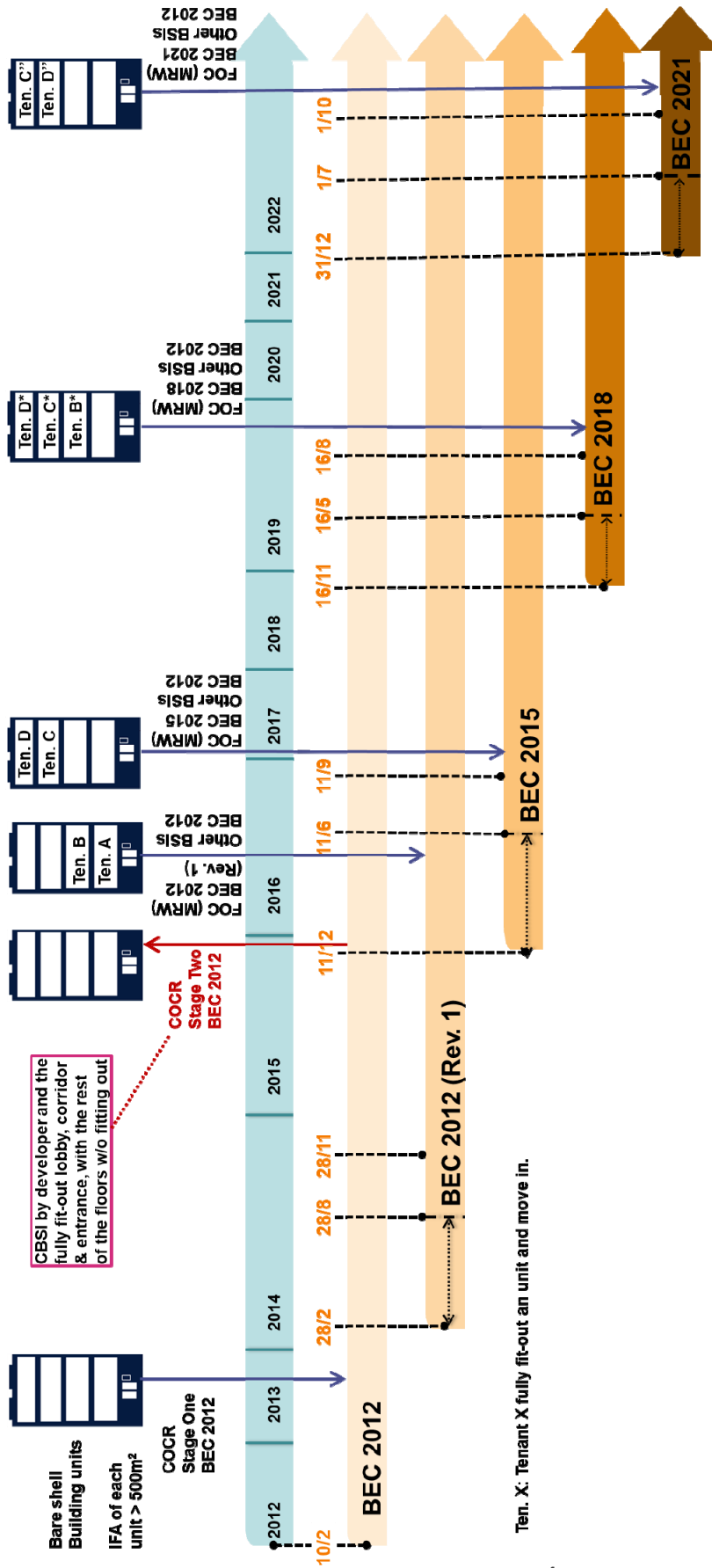
- BEC 2012 takes effect since 10 February 2012;
- BEC 2012 (Rev. 1) was issued on 28 February 2014 with 6 and 9 months grace periods on the newly constructed building and the existing building respectively;
- BEC 2015 was issued on 11 December 2015 and takes effect on 11 June and 11 September 2016 (the same grace periods as BEC 2012 (Rev. 1)) for the newly constructed building and the existing building respectively.
- BEC 2018 was issued on 16 November 2018 and takes effect on 16 May and 16 August 2019 (the same grace periods as BEC 2012 (Rev. 1) and BEC 2015) for the newly constructed building and the existing building respectively.
- BEC 2021 was issued on 31 December 2021 and takes effect on 1 July and 1 October 2022 (the same grace periods as BEC 2012 (Rev. 1), BEC 2015 and BEC 2018) for the newly constructed building and the existing building respectively.
- There are different BEC editions in effect concurrently on and after 1 July 2022.

BEC 2012, BEC 2012(Rev. 1), BEC 2015, BEC 2018 are still:

- applicable to newly constructed building being declared by the developer in stage one under construction
- applicable to the building issued with the COCR to that Edition

Building owner / Owner of CBSI, responsible person should maintain the central building services installations in that building or building services installations serving the unit of that building to a standard not lower than the BEC Edition at the corresponding COCR issued. (Section 12 & 13 of BEEO)

Figure 4.4.3 : Applicability of the BEC Editions



Consider in 3<sup>rd</sup> quarter of 2013, a developer makes a stage one declaration for his office building. Having the BEC 2012 in effect, the energy efficiency of the BSIs being designed and will be installed and completed by the developer complies with this BEC edition. The developer intends to leave the lease out areas on the typical floors, each unit with internal floor area well exceeding 500m<sup>2</sup>, under bare shell conditions and conducts full fit-out works on the front-of-house areas including the main entrance, the lift lobbies, circulation corridors and the toilets on typical floors only. In 2015, the developer makes a stage two declaration, by referencing to the BEC edition reported on the stage one declaration (i.e. the BEC 2012) for the building. The building is subsequently granted with a COCR to the BEC 2012 near the year end of 2015.

Consider tenants moving in occupying the lower floors in early 2016 (the Tenant A and Tenant B refers in the Figure). At this time, the BEC 2012 and BEC 2012 (Rev. 1) are in effect concurrently while the BEC 2015 has been issued and is in the associated grace period.

Any BSI fit-out works, which is regarded as non-major retrofitting works, taking up by the tenants should comply with the BEC edition as stated in the COCR i.e. the BEC 2012. The works typically refers to the electrical installation in each of the tenant areas. This is the tenant's obligation, as the responsible person of a unit, to maintain the BSI to a standard not lower than that applied in the first COCR issued in respect of the building pursuant to section 12(4) of the Ordinance.

In the meantime, any BSI fit-out works, which is regarded as the major retrofitting works, taking up by the tenants should comply with the latest BEC edition in force, i.e. the BEC 2012 (Rev. 1), in this example. The works typically refers to the lighting installation in respect of the LPD (lighting power density) requirements. Each of the tenants (i.e. the Tenant A and Tenant B) should obtain a FOC to BEC 2012 (Rev. 1) covering the major retrofitting works from an REA.

Consider tenants moving in occupying the upper floors in late 2016 (the Tenant C and Tenant D refers in the Figure). At this time, the BEC 2012, BEC 2012 (Rev. 1) and BEC 2015 are in effect concurrently.

Similar to the case explained before, any BSI fit-out works, not regarded as the major retrofitting works, taking up by Tenant C and D should comply with the BEC 2012. In the meantime, any BSI fit-out works, being regarded as the major retrofitting works, taking up by Tenant C and D should comply with the latest BEC edition in force i.e. the BEC 2015 at this period of time. The works typically refers to the lighting installation in respect of the LPD and automatic lighting control requirements. Each of the tenants (the Tenant C and Tenant D) is obliged to obtain a FOC to BEC 2015 covering the major

retrofitting works from an REA.

Consider tenant B, C and D moved out and tenant B\*, C\* and D\* moved in occupying the upper floors in late 2019. At this time, the BEC 2012, BEC 2012 (Rev. 1), BEC 2015 and BEC 2018 are in effect concurrently. In this meantime, the major retrofitting works completed in late 2019 should comply with the latest BEC edition in force i.e. the BEC 2018 at this period of time.

Consider tenant C\* and D\* moved out and tenant C" and D" moved in occupying the lower floors in late 2022. At this time, the BEC 2012, BEC 2012 (Rev. 1), BEC 2015, BEC 2018 and BEC 2021 are in effect concurrently. In this meantime, the major retrofitting works completed in late 2022 should comply with the latest BEC edition in force i.e. the BEC 2021 at this period of time.

#### 4.4.4 Repairs and Retrofits

Further to TG clause 4.4.1, should a repair or retrofit (not of the scope of major retrofitting works) be carried out to a building services installation in a building with COCR or to an installation covered by a FOC, the maintaining of design standard at the standard of the applicable BEC version should apply to the repair and retrofit, illustrative examples given in Table 4.4.4 below.

<b><u>Table 4.4.4 : Maintaining of Design Standard for Repairs or Retrofits (not of the scope of major retrofitting works) in Buildings with COCR or in Works Covered by FOC</u></b>	
Replacement of a motor	Replacing motor to comply with minimum motor efficiency levels in BEC Table 7.5.1
Replacement of the compressor of a chiller	Replacing compressor should have an efficiency such that the chiller complies with the minimum COP levels in BEC Table 6.12b
Lighting retrofit	LPD of retrofitted lighting installation to comply with maximum allowable LPD values in BEC Table 5.4
Change in size of ductwork section of an air distribution system for a conditioned space	The change should not incur the non-compliance with the system fan motor power requirements in BEC clauses 6.7.1 to 6.7.3 and 6.7.5

The maintaining of design standard accepts normal wear and tear, which affects the energy performance of the concerned installations or equipment. Examples of normal wear and tear are a condenser coil having lower heat transfer as a result of minor fins

corrosion, a motor having lower efficiency as a result of minor wearing of its bearings, an evaporator of a chiller requiring the plugging of a tube given the tube being beyond repair. Having accepted the wear and tear, it is recommended as good engineering practice that repairs should be carried out to the concerned installations or equipment, to bring close to their respective levels of performance as at the issue of the COCR or the applicable FOC.

#### 4.4.5 Change of Use

Further to TG clause 4.4.1, in respect of a change of use of a building services installation to which the Ordinance or BEC did not apply before the change but applies after the change, the maintaining of design standard at the standard of the applicable BEC version should apply to the concerned building services installation, which if not at the standard should be brought up to the standard. An illustrative example is the change of an office space to a store room, where there is a reduction of the allowable LPD level which is now presumably lower than the installed LPD (previously for office); the lighting installation in the store room should be brought to the allowable LPD level for store room by means of replacement with lower wattage lamps or removal of luminaires.

#### 4.5 Demonstration of Compliance Using Specified Forms and Technical Forms (BEC clause 4.5)

The declarations and the FOC in TG clause 4.2 above are to be submitted/issued in the corresponding forms, and be accompanied with the prescribed fees and the documents specified in the forms. There are two types of forms, namely specified forms and technical forms, the former on administrative items, and the latter on technical engineering items in the BEC. TG Table 4.5 (a) and Table 4.5 (b) below show respectively the lists of specified forms and technical forms (for the sake of clarity, the version no. of the technical forms are not shown). The decorations are to be made on specified forms EE1 and EE2 respectively, with supplementary information to be provided in form EE-SU and technical engineering information of the building services installations provided in forms EE-LG, EE-AC, EE-EL, EE-LE, EE-PB as appropriate in respect of the compliance with the relevant clauses in the BEC. Each sets of technical form for each BEC version are coexist and are made available for download at the web-site of the Ordinance.

<b>Table 4.5 (a) : List of Specified Forms (BEC Compliance), Cap 610</b>	
<u>Form No.</u>	<u>Type of Form</u>
EE1	Stage One Declaration
EE2	Stage Two Declaration

EE3	Application for Renewal of COCR
EE4	FOC
EE-SU	Supplementary Information for Forms EE1, EE2, EE3 or EE4
EE-EX	Application Form for Exemption from Specified Standards and Requirements for COCR, FOC or Energy Audit

**Table 4.5 (b) : List of Technical Forms (BEC Compliance)**

<u>Form No.</u>	<u>Type of Form</u>
EE-LG 2021	Technical Data of Lighting Installation for BEC 2021
EE-AC 2021	Technical Data of Air-conditioning Installation for BEC 2021
EE-EL 2021	Technical Data of Electrical Installation for BEC 2021
EE-LE 2021	Technical Data of Lift & Escalator Installation for BEC 2021
EE-PB 2021	Technical Data of Performance-based Approach for BEC 2021
EE-LG 2018	Technical Data of Lighting Installation for BEC 2018
EE-AC 2018	Technical Data of Air-conditioning Installation for BEC 2018
EE-EL 2018	Technical Data of Electrical Installation for BEC 2018
EE-LE 2018	Technical Data of Lift & Escalator Installation for BEC 2018
EE-PB 2018	Technical Data of Performance-based Approach for BEC 2018
EE-LG 2015	Technical Data of Lighting Installation for BEC 2015
EE-AC 2015	Technical Data of Air-conditioning Installation for BEC 2015
EE-EL 2015	Technical Data of Electrical Installation for BEC 2015
EE-LE 2015	Technical Data of Lift & Escalator Installation for BEC 2015
EE-PB 2015	Technical Data of Performance-based Approach for BEC 2015
EE-LG	Technical Data of Lighting Installation for BEC 2012 / BEC 2012 (Rev.1)
EE-AC	Technical Data of Air-conditioning Installation for BEC 2012
EE-EL	Technical Data of Electrical Installation for BEC 2012
EE-LE	Technical Data of Lift & Escalator Installation for BEC 2012
EE-PB	Technical Data of Performance-based Approach for BEC 2012

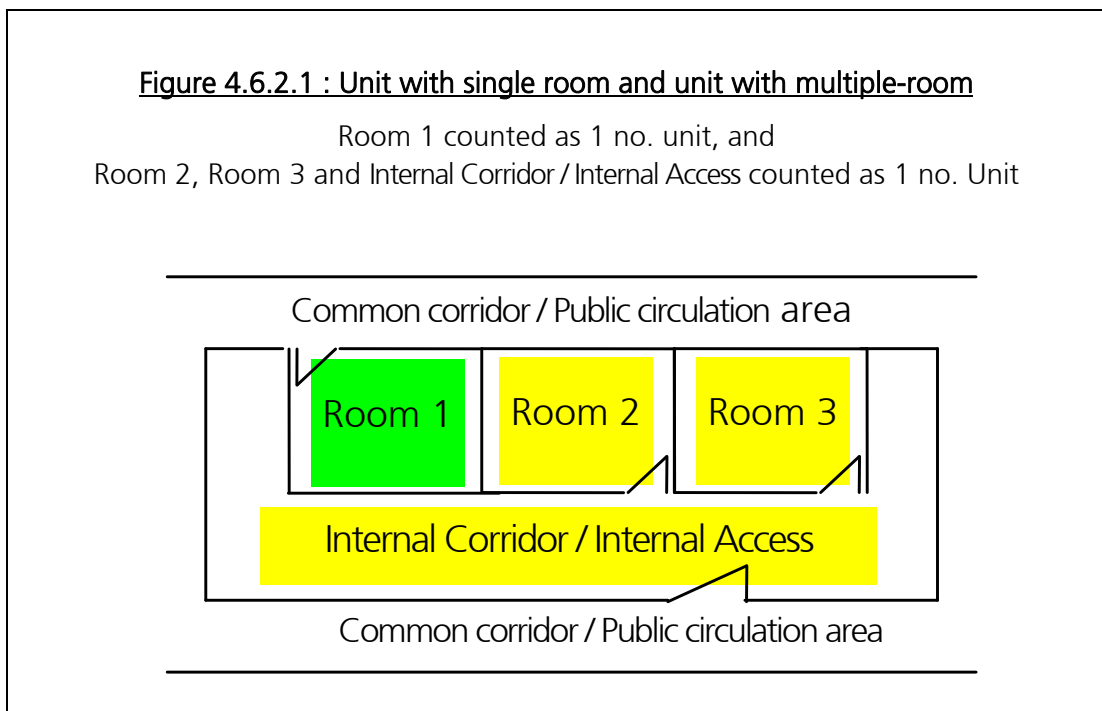
4.6 Responsible Person, Unit, Clubhouse & Carpark, and Residential Unit & Industrial Unit

4.6.1 Responsible Person

TG clauses 4.2.2 and 4.2.3 introduce the responsibilities of the owner and the responsible person, in respect of building services installations in the common area and in units. Based on the interpretation of responsible person (TG Section 2), if the building services installation in a unit is owned and controlled by the owner of the building and not the unit’s leasing tenant, the responsible person may be the owner of the building.

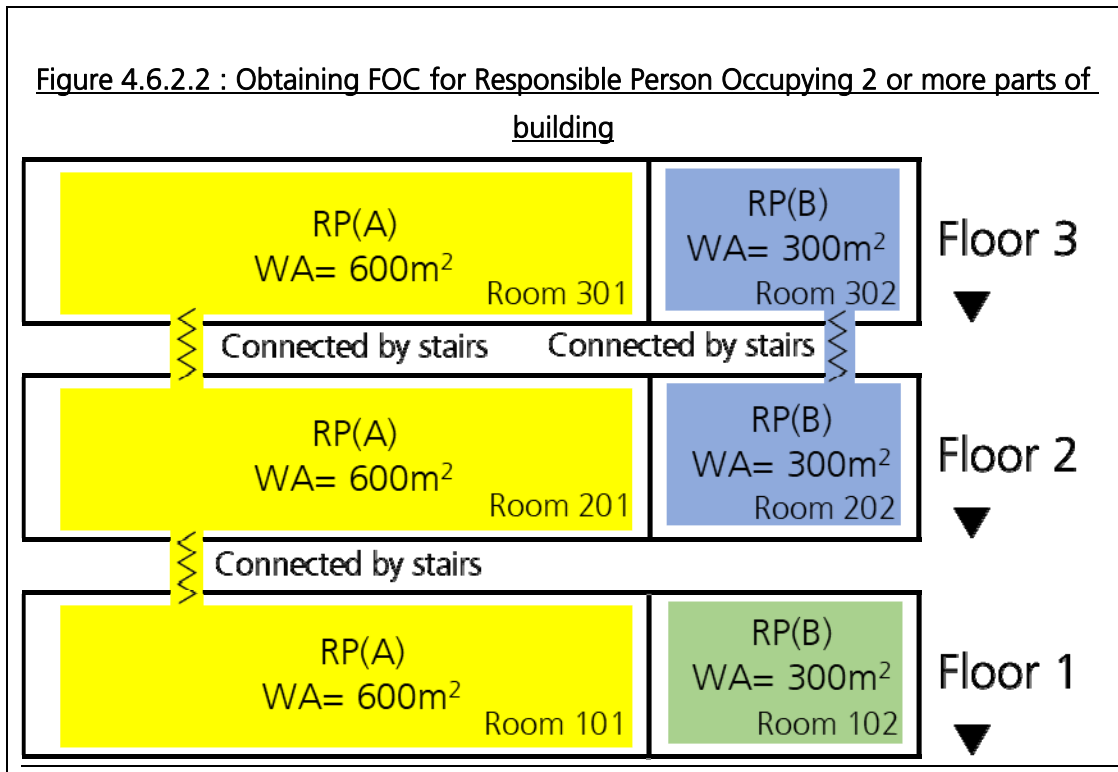
4.6.2 Unit

4.6.2.1 In general, a unit that is interpreted in TG Section 2 usually has full-height partition wall or vertical physical segregation and direct access to common corridor, common lobby, or public circulation area. A “unit” may consist of more than one room, as shown in Figure 4.6.2.1 below.



4.6.2.2 When one responsible person is occupying more than one unit (not a common area) within a building on different floors, where the units are not interconnected by any means, including but not limited to staircase or internal corridor/access, the major retrofitting works at each unit should apply for a corresponding FOC. A sample scenario is shown in Figure 4.6.2.2 below.





Consider Responsible Person (A) (RP(A)) takes up Room 101, 201 and 301 with two internal stairs for interconnecting the three rooms, they are considered as one unit under BEEO. The Works Area (WA) of Room 101, 201 and 301 are 600m² each. Hence the total Works Area is 1,800m² and should be cover by one FOC for MRW.

Room 102, 202 and 302 are occupied by Responsible Person (B) (RP(B)) while only Room 202 and 302 are interconnected by internal stairs. Room 202 and 302 are hence regarded as one unit while Room 102 is regarded as another unit. As the Works Area of room 102 is 300m² only (less than 500m²), it is not classified as MRW. For Room 202 and 302, the total Works Area is 600m², FOC should then be obtained for the MRW.

#### 4.6.3 Clubhouse and Carpark

4.6.3.1 An occupants' clubhouse or a car park, unless otherwise stated in the DMC or OA, can be regarded as a separate common area within the building according to Note (1)(a) to Schedule 3 of the Ordinance (extracted in TG Table 4.2.5). With them being separate common areas, the aggregate of works areas in the clubhouse is thus independent from that of the car park, and likewise independent from the remaining common area such as common lobbies, corridors, staircases etc. Take for example a retrofit involving say 300 m² of the clubhouse, 300 m² of the car park and 300 m² of the common lobbies, corridors and staircases. The 500 m² criterion of major retrofitting works (TG clause 4.2.5.1) is not applicable in this case, as the works area in each of these three common areas when measuring separately and independently from each other is only 300 m², and as such the involvement of a FOC is not required.

4.6.3.2 TG Table 4.6.3.2 below shows the applicability of BEC requirements to an occupant's

clubhouse or a car park, for the so listed prescribed building categories. The applicability is subject to the conditions stated in TG clauses 4.6.3.3 & 4.6.3.4 that follow.

<b>Table 4.6.3.2 : Applicability of the BEC Requirements to an Occupant’s Clubhouse or a Car Park</b>		
<u>Category of Building (in which the clubhouse or car park is located)</u>	<u>Building with Common Area</u>	<u>Building with No Common Area</u>
Residential building	Yes	No
Commercial building	Yes	
Composite (commercial / residential) building	Yes, if the clubhouse or car park has a commercial portion and the applicability is to this commercial portion	

4.6.3.3 In the case of car park, its areas that are regarded as common area should however not include the parking spaces that have been specified in instruments registered in the Land Registry as being for the exclusive use of the respective owners of the parking spaces, implying that the applicability of the BEC requirements are limited to areas such as common driveway, loading/unloading spots, walkways etc. outside these parking spaces.

4.6.3.4 The applicability in TG Table 4.6.3.2 is the applicability in respect of a relevant portion of the building, and not in respect of a building services installation, which is yet to be checked for the applicability of the Ordinance by nature and type of the installation such as CBSI, non-CBSI, owned by owner of building, exclusion by virtue of Schedule 2 of the Ordinance etc.

4.6.4 Residential Unit and Industrial Unit

Attention is drawn to the BEC’s non-applicability to residential units and industrial units, as described in TG clause 3.2.3.

4.7 Summary of Requirements

The developer, owner and responsible person of building(s), unit(s) in building(s) and CBSI should check for his/her building if the Ordinance is applicable to his/her building(s), unit(s) and building services installations –

- (a) identify if the building is a prescribed building under Schedule 1 of the Ordinance (also refer TG Table 3.1.1) where the developer, building owner or responsible person might be asked to present the relevant document for assessing if the concerned building is one of the prescribed building types under the Ordinance;

- (b) check if the building is excluded from the requirements of the Ordinance by virtue of fulfilling the conditions prescribed in sub-sections 4(1) or 4(2) of the Ordinance (refer also TG Table 3.2.4 re sub-sections 4(1) and 4(2) of the Ordinance); and
  - (c) for a building to which the Ordinance is applicable,
    - i) for newly constructed building
      - make REA-certified declarations and obtain the COCR (pursuant to Part 2 of the Ordinance, refer also TG Table 4.2.2),
      - ensure his/her building services installations comply with the BEC, and
      - renew the COCR upon expiry after 10 years,
    - ii) for each lot of major retrofitting works
      - ensure his/her building services installations comply with the BEC, and
      - obtain from an REA the FOC (pursuant to Part 3 of the Ordinance, refer also TG Table 4.2.3),
- taking into consideration the applicable exclusions in Schedule 2 of the Ordinance (refer also TG Table 3.2.4 re Schedule 2 of the Ordinance), and
- iii) maintain the building services installations to the standard of the applicable BEC version (refer TG clause 4.4).

#### 4.8 Other Legislative Provisions

Other than described above, the Ordinance has set out for purpose of its enforcement the mechanism for -

- application to the Director for exemption from specified standards and requirements, and for extension of the period for making declaration and obtaining FOC,
- issue of improvement notice by the Director to the party contravening a requirement under the Ordinance,
- empowering an authorized officer (of EMSD) to enter a building and conduct inspection and to require the responsible person to produce relevant documents,
- appeal, and
- penalties for offences, majority in the form of monetary fines, whereas penalties for the provision of false or misleading information or for the obstruction of authorized officer in the exercise of power would involve imprisonment.

## 5 Energy Efficiency Requirements for Lighting Installation

### 5.1 Scope of Application (BEC clause 5.1)

#### 5.1.1 Comprehensive View on Applicability (BEC clause 5.1.1)

BEC Section 5 provides the guidelines for lighting installations. To gain a comprehensive view in relation to the Ordinance, BEC clause 5.1 should be read in conjunction with –



- BEC Sections 3 & 4 that briefly describe the scope and limits of the application of the Ordinance based on its prescribed requirements in Parts 2 & 3; and
- TG Sections 3 & 4 that elaborate on the scope and limits of application and the necessary steps to demonstrate the compliance with the Ordinance and the BEC.







For reference, the interpretation of ‘lighting installation’ under the Ordinance and the BEC is extracted below -


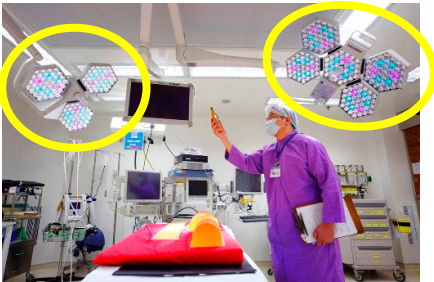


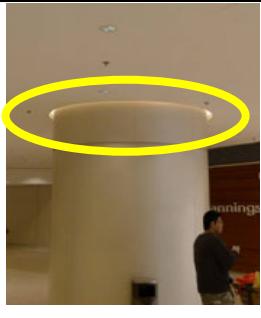
<b>Table 5.1.1 : Definition of Lighting Installations</b>
<p>‘Lighting installation’, in relation to a building, means a fixed electrical lighting system in the building including -</p> <ul style="list-style-type: none"> <li>(a) general lighting that provides a substantially uniform level of illumination throughout an area; or</li> <li>(b) maintained type emergency lighting,</li> </ul> <p>but does not include non-maintained type emergency lighting;</p>







#### 5.1.2 Examples of BEC Non-applicable Installations (BEC clause 5.1.2)


BEC clause 5.1.2 lists certain lighting installations to which the Ordinance does not apply, and further examples of these installations are given in TG Table 5.1.2 below.

<b>Table 5.1.2 : Examples of BEC Non-applicable Lighting Installations</b>	
<u>Examples</u>	<u>Justifications</u>
<p>(a) Outdoor lighting illuminating building facade</p> <div style="display: flex; justify-content: space-around;">   </div>	<p>BEC clause 5.1.2 (a)</p>

		
<p>(b) Lighting on outdoor lamp-pole</p>		<p>BEC clause 5.1.2 (a)</p>
<p>(c) Desk lamp with flexible cable &amp; plug</p>		<p>BEC clause 5.1.2(b)</p>
<p>(d) Film viewer to view X-ray film (commonly found in medical clinics)</p>		
<p>(e) Lighting integral to a fume cupboard</p>		<p>BEC clause 5.1.2(c)</p>
<p>(f) Lighting integral to food-warming equipment (e.g. in restaurants)</p>		
<p>(g) Lighting integral to exit sign or directional sign</p>		<p>BEC clause 5.1.2(d)</p>

<p>(h) Lighting integral to signage for promoting a specific brand, product or service</p>		
<p>(i) Lighting in an operating theatre in a hospital, lighting solely used for surgical operation</p>		<p>BEC clause 5.1.2(f) (fulfilling item 2(a), Schedule 2 of the Ordinance)</p>
<p>(j) Lighting solely for illuminating art work or exhibit</p>		<p>BEC clause 5.1.2(f) (fulfilling item 6(a), Schedule 2 of the Ordinance)</p>
<p>(k) Lighting solely for illuminating merchandise on display (commonly found in retail shops)</p>		
<p>(l) Lighting solely for outlining the ceiling and circular column interface</p>		<p>BEC clause 5.1.2(f) (fulfilling item 6(b), Schedule 2 of the Ordinance)</p>

<p>(m) Lighting solely to outstand architectural profile</p>		
<p>(n) lighting solely for providing festival decoration effect</p>		
<p>(o) Lighting solely for conducting of performance (commonly found in and around performance stages)</p>		<p>BEC clause 5.1.2(f) (fulfilling item 6(c), Schedule 2 of the Ordinance)</p>
<p>(p) Lighting solely for research in an educational institution.</p>		<p>BEC clause 5.1.2(f) Fulfilling item 5, Schedule 2 of the Ordinance.</p>
<p>(q) Luminaires for sale and not for illuminating a space</p>		<p>Luminaires are regarded as merchandise (or product) instead of lighting installation.</p>
<p>(r) Non-maintained type emergency lighting (with battery-pack) operating only during failure of normal power</p>		<p>Outside the scope of lighting installation interpreted in the Ordinance, which does not cover non-maintained type emergency lighting</p>

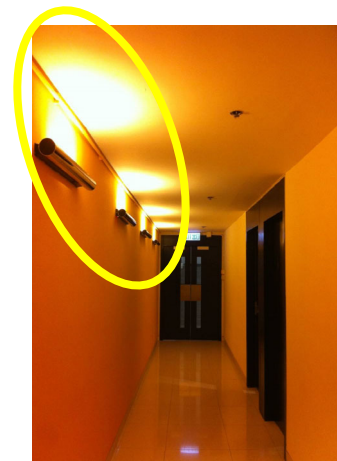
<p>(s) Lighting in a declared monument or a declared historical building under section 3 of the Antiquities and Monuments Ordinance (Cap 53)</p>		<p>The Ordinance is not applicable, as prescribed in sub-sections 4(1)(c) and 4(1)(d) of the Ordinance</p>
<p>Remarks : The justification above is subject to the fulfilling of the separate control circuitry requirement as described in TG clause 5.5.4. Instead, providing a separate control circuitry to a lighting installation is <u>not</u> the prerequisite if such lighting installation is governed under the Ordinance.</p>		

5.1.3 Lighting Serving Both as General Lighting and for Purpose Prescribed in Item 6 of Schedule 2 of the Ordinance

In the justifications for certain examples in TG Table 5.1.2 above (items (j) to (o) in particular), the non-applicability of the Ordinance or BEC is by virtue of the lighting installation fulfilling item 6 of Schedule 2 of the Ordinance (also refer TG Table 3.2.4). Attention is drawn that, by definition as extract in TG Table 5.1.1 above, should the lighting installation provides a substantially uniform level of illumination throughout an area, it is regarded as general lighting and there would be no exemption.


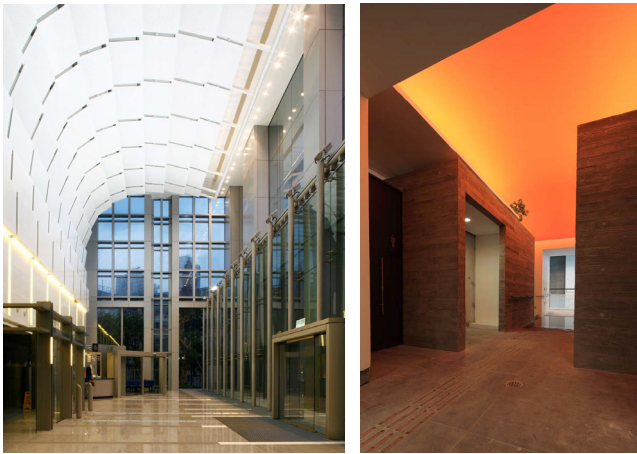

For example in a corridor in a hotel, as shown in TG Figure 5.1.3, should the illumination be provided also by a series of uplights, which serve both purposes namely general illumination and decoration, the uplights are governed by the BEC, and the LPD of the corridor has to comply with the corresponding maximum allowable value in BEC Table 5.4.



**Figure 5.1.3 : Lighting serving as general lighting and decoration**



The physical appearance of luminaires and the provision of separated circuitry do not render such lightings be regarded as for the sole use of decoration. Design scope under the interior designer or lighting consultant does not differentiate functional lighting from the decoration lighting. When in doubt, the developer should consult the EMSD, in the presence of the designers/REA before finalizing the lighting design. Further examples are illustrated in TG Table 5.1.3 below.



<u>Table 5.1.3 : Examples of Lighting Installation that may not be considered as solely uses for decoration</u>	
<u>Examples</u>	<u>Justifications</u>
<p>(a) Panel type ceiling lighting</p> 	<p>The panel type ceiling light is not regarded as solely used for decoration when it provides a substantially uniform level of illumination throughout such space.</p>
<p>(b) Indirect light</p> 	<p>Indirect light might not be regarded as solely used for decoration when it provides a substantially uniform level of illumination throughout such space.</p>
<p>(c) Lighting besides mirror</p> 	<p>Vertical or wall mounted lighting besides the mirror allows an individual standing in front of the mirror become desirably visible. The lighting is therefore regarded as serving a functional purpose.</p>

<p>(d) Cove Lighting</p> 	<p>Continuous and/or extensive cove light, in particular at a relatively small lighting space, not regarded as solely used for decoration since it provides a substantially uniform level of illumination throughout such space.</p>
<p>(e) Underwater Lighting at Swimming Pool</p> 	<p>Underwater lighting at a swimming pool allows users to view clearly under water and provides direction. It cannot regard as solely used for decoration.</p>

## 5.2 General Approach (BEC clause 5.2)

The energy efficiency requirements in BEC clauses 5.4 to 5.6 are based on the general approach to energy efficiency given in BEC clause 5.2.

## 5.3 Definitions (BEC clause 5.3)

BEC Section 2 provides the interpretations and abbreviations related to the BEC and the Ordinance, including those for lighting installation. The definition of the lighting power density (LPD) is defined in the BEC 2021 and is extracted below.

**Table 5.3 : Definition of Lighting Power Density**

'Lighting power density (LPD) (unit : W/m<sup>2</sup>)' means the maximum circuit wattage consumed by fixed lighting installations per unit floor area of an illuminated space.

(In equation form, the definition of LPD is given by:

$$LPD = \frac{\text{Total circuit wattage of the fixed lighting installations}}{\text{Internal floor area of that space}}$$

,where the total circuit wattage should be taken at the full lighting output condition. )

Attention is drawn to the fact that the total circuit wattage of the fixed lighting installations should be taken at the full lighting output condition and hence the subsequent LPD compliance demonstration. This serves to stress that the compliance with the LPD requirement is achieved by proper selection of lamp source, luminaires and the layout design. Compliance through reducing the light output by dimming device even provided with fix-and-locked device is considered as unacceptable practice.

#### 5.4 Lighting Power Density (LPD) (BEC clause 5.4)

##### 5.4.1 Maximum Allowable LPD (BEC clause 5.4.1)

###### (a) Classifying of Space as Type of Space in BEC Table 5.4

Maximum allowable LPD values and the requirement of automatic lighting control for concerned areas are specified in BEC Table 5.4. The REA/designer should classify an applicable space in a design as one of the types of space in BEC Table 5.4. New types of space are introduced such as "Activity Room/Children Play Area/Music Room/Recreational Facilities Room", "Babycare Room/Breastfeeding Room/Lactation Room", "Medical Examination Room", "Pharmacy Area", "Report Room (Police Station)", "Security Room/Guard Room", "Spa Room/Massage Room". There may be spaces in the design that are not identically named as those in BEC Table 5.4, and under the circumstance the REA/designer should exercise his/her professional judgment on the function of the space to make the classification. If the REA/designer is in doubt, he/she should seek EMSD's advice. Certain examples of the classification are given below.

###### Reference to surrounding space

Take for example a space under design being dedicated as "reception area" for an office set-up. Since "reception area" is not included in BEC Table 5.4, the REA/designer can reasonably classify the space as "office" in Table 5.4. Similarly should the "reception area" be used for a gymnasium set-up, the space may be classified as "gymnasium" in Table 5.4.

#### Demarcation based on function and nature

Consider another example of a passage under design being dedicated as mainly for circulation of in-house staff, the passage may be regarded as "corridor", whereas a similar passage mainly for the public may be regarded as "public circulation area".

A place serving food and has a restaurant license (issued by Food and Environmental Hygiene Department) may be regarded as "restaurant", whereas one with a canteen license may be regarded as "canteen".

"Computer Room/Data Centre" may be regarded as a relatively large area primarily for equipment racks handling electronic data processing and storage subject to relatively high requirements on environmental control and lighting level. In comparison, "Server Room/Hub Room" may be regarded as a space used for housing IT or networking equipment occupying relatively small area with less stringent requirement on environmental control and lighting level.

#### Automatic Lighting Control

The requirements on automatic lighting control to dedicated spaces are specified in third column of BEC Table 5.4.

In toilet spaces, the BEC allows both occupancy sensor and time scheduling for means of automatic lighting control. However, dimming instead of total shut down is recommended for avoiding the risk of inducing nuisance to the occupants.

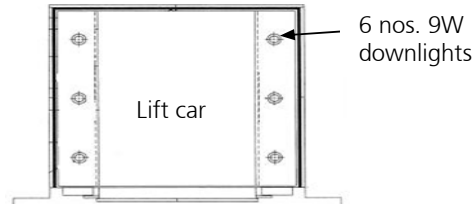
In Library (Reading Area or Audio-Visual Centre, Stack Area) and Exhibition Hall / Gallery, the BEC allows both occupancy sensor and time scheduling for means of automatic lighting control. These lighting spaces are normally operated in regular schedule and with extensive lighting zones, which automatic time scheduling could be considered to ensure the lightings could be properly switch-off when the associated spaces are closed.

As a good engineering practice, the REA/designers are encouraged to adopt automatic lighting control to those types of space not shown on BEC Table 5.4 to maximize the potential energy saving.

(b) Space with Less than 70W Lighting Installation

According to BEC clause 5.4.1, a space having total electrical power of fixed lighting installations not exceeding 70 W is not governed by the LPD requirement in BEC Table 5.4. This is to avoid the imposing of unnecessary inflexibility in the choice of luminaires for a small area space of which the LPD based on Table 5.4 can easily be exceeded even with a minimum no. of luminaires. Examples of a small area space are a store room and a lift car. The lift car example is illustrated in TG Figure 5.4.1(a), which shows a lighting installation less than 70W.

**Figure 5.4.1 (a) : BEC LPD requirement not applicable to lift car with < 70 W lighting**



(c) Internal Floor Area

In calculating the LPD of a space, the internal floor area measuring from the internal surfaces of the enclosing walls should be used. The area should include the thickness of columns and party walls, if any, within the space.

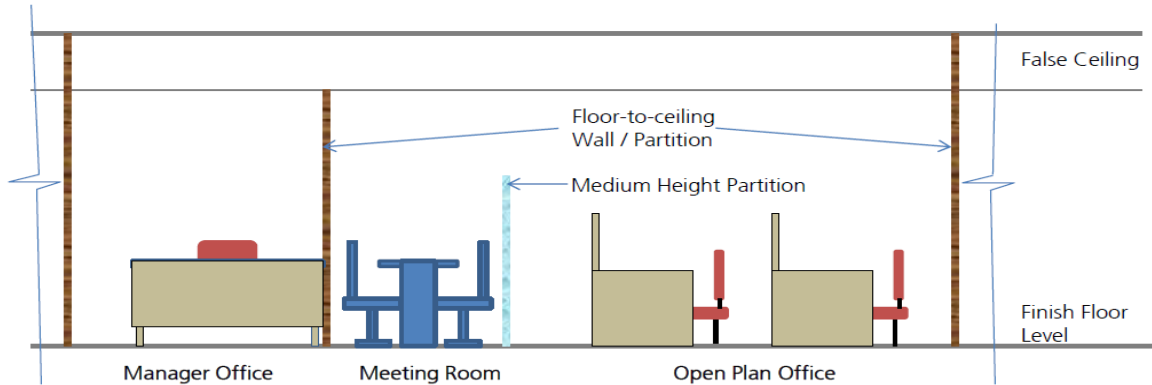
5.4.2 LPD of BEC Non-applicable Lighting Installations (BEC clause 5.4.2)

Given the BEC's non-applicability to these lighting installations, their inclusion in the LPD calculation is not required. On assessing if a concerned lighting installation might be excluded from LPD calculation, the developer/ responsible person or the designer /REA might be requested for furnishing the necessary information as substantiation. The formation may include, but not limit to, layout, elevation, on-site lighting level measurement, photo of the concerned installation and photomontage illustrating the lighting effect etc.

5.4.3 Separation Between Spaces (BEC clause 5.4.3)

For the purpose of LPD calculation, two adjoining spaces are considered as separate individual spaces when they are segregated by full height physical walls or partitions. In TG Figure 5.4.3 below, the Manager Office and the Open Plan Office are regarded as two separate spaces, given them being isolated with floor to ceiling partitions, and the LPD in each space is to be calculated separately. For the Meeting Room, given it being only isolated with a medium height partition from the working stations in the Open Plan Office, it is regarded as a part of the Open Plan Office, and in calculating the LPD the electrical power of the luminaires in the meeting zone and those in the work station zone can be added up and be divided by the sum of the areas of the two zones.

**Figure 5.4.3 : Separation between spaces**



#### 5.4.4 Multi-functional Space (BEC Table 5.4)

A multi-functional space is one that can function as more than one of the space types in BEC Table 5.4; meaning of multi-functional space is also described in BEC Section 2. It is designed to allow different functional activities at different times, with each function served by a combination of luminaires in the same space. Noteworthy, a luminaire in a multi-functional space may serve more than one function. The LPD of each combination of luminaires should not exceed the maximum allowable value corresponding to the type of space illuminated by that combination of luminaires. A typical example is a multi-function room in a hotel, which can function as a banquet room, a ball room or a seminar room. When the room is used as a banquet room or a ball room, its LPD provided by the function-specific combination of luminaires should not exceed  $17.0 \text{ W/m}^2$ , and when used as a seminar room  $12.8 \text{ W/m}^2$ . An illustration of the LPD calculation is given in TG clause 5.7.

#### 5.5 Lighting Control Point (BEC clause 5.5)

##### 5.5.1 Lighting Control Point (BEC clause 5.5.1)

###### (a) Required Quantity

The requirement on lighting control point extends to cover all types of lighting space. The BEC governs that the area of a single lighting control point should not cover more than  $500\text{m}^2$  for any type of lighting space other than office. According to BEC clause 5.5.1, a space having total electrical power of fixed lighting installations not exceeding  $70 \text{ W}$  is not governed by the lighting control point requirement. Examples of a small area space are a plant room, a store room and a disabled toilet.

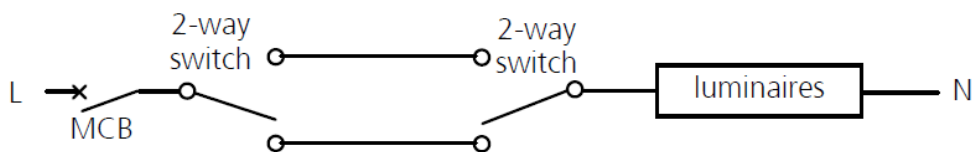
BEC Table 5.5 specifies the equations for determining the minimum no. of lighting control points for an office space. Based on the calculations using these equations, TG Table 5.5.1 below gives the corresponding minimum no. of lighting control points for office space areas up to  $500\text{m}^2$ . Office space with area exceeding  $500\text{m}^2$  should have the no. of lighting control points so determined to BEC Table 5.5.

<b>Table 5.5.1 : Minimum Nos. of Lighting Control Points per Space Area of Office</b>			
<u>Area (m<sup>2</sup>)</u>	<u>Minimum no. of lighting control points</u>	<u>Area (m<sup>2</sup>)</u>	<u>Minimum no. of lighting control points</u>
> 0 - 15	1	> 180 - 210	12
> 15 - 30	2	> 210 - 240	13
> 30 - 45	3	> 240 - 270	14
> 45 - 60	4	> 270 - 300	15
> 60 - 75	5	> 300 - 330	16
> 75 - 90	6	> 330 - 360	17
> 90 - 105	7	> 360 - 390	18
> 105 - 120	8	> 390 - 420	19
> 120 - 135	9	> 420 - 450	20
> 135 - 150	10	> 450 - 500	21
> 150 - 180	11	> 500	Follows BEC Table 5.5

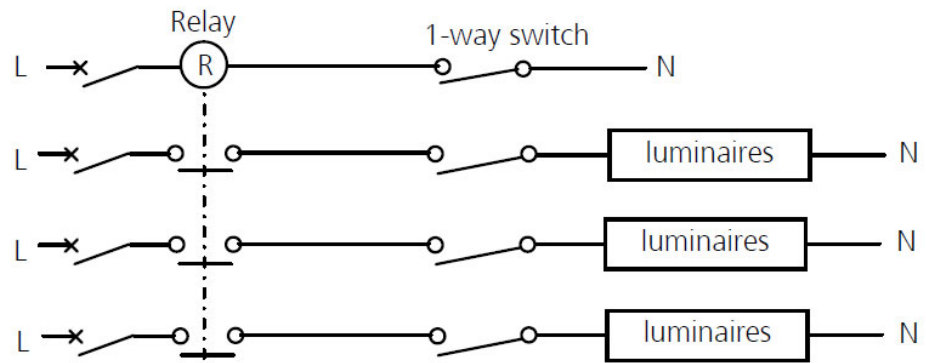
Note on Interpretation

A lighting control point can be in the form of a manual on/off switch, a 2-way control, and a relay or contactor switch.

The following lighting circuit with 2-way control is regarded as having two nos. lighting control points.



The following lighting circuit with a relay control, which is activated via manual switching, sensor or timer operated etc., is regarded as having 4 nos. lighting control points. (The “sensor” or “timer” are not regarded as lighting control point but the devices as necessary for activation of the relay.)



5.5.2 Allowable Reduced Nos. of Lighting Control Points for Office (BEC clause 5.5.2)

Reduced nos. of lighting control points in an office space is allowed, subject to the actual LPD value in the space being lower than the maximum allowable value of 7.8 W/m<sup>2</sup> (Office, internal floor area above 200 m<sup>2</sup>) –

$$\text{Allowable reduction ratio} = \frac{7.8 \text{ W/m}^2 - \text{actual LPD}}{7.8 \text{ W/m}^2}$$

Example below further illustrates the allowable reduction in nos. of control points –

Area of open plan office : 350 m<sup>2</sup>

Min no. of lighting control points required : 17 (refer TG Table 5.5.1)

Calculated actual LPD : 7 W/m<sup>2</sup>

Max allowable LPD : 7.8 W/m<sup>2</sup>

Allowable reduction ratio = (7.8-7)/7.8 = 0.1 (or 10%)

Min no. of lighting control points required after reduction = 17 x (1-0.1) = 15.3 or 16 with rounding up to an integer

Lighting control reduction is not applicable to other types of lighting space given the fact that the quantity of control point is determined using a single criterion i.e. the 500m<sup>2</sup>.

5.5.3 Lighting Control Points for Multi-functional Space (BEC clause 5.5.3)

The control circuitries of the luminaires in a multi-functional space should be such that each of the function-specific combinations of luminaires can operate independently from each other.

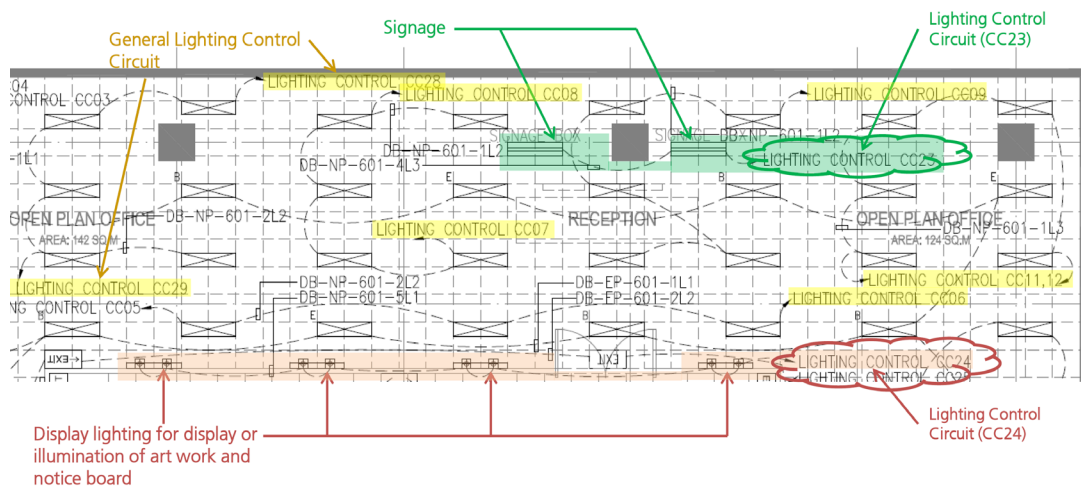
5.5.4 Separate Control for Ordinance-applicable Lighting and Ordinance Non-applicable Lighting (BEC clause 5.5.4)

The separate control requirement is to facilitate the flexibility in the operation of the



applicable lighting and non-applicable lighting, such that each of these two categories can be switched on or off independently. TG figure 5.5.4 below shows the lighting layout of a sample office set-up where there are luminaires for general lighting, luminaires solely for signage and luminaires solely for display or illumination of art work and notice board, in which it can be seen that each of the latter two categories of luminaires has its own control circuitry. Proper switching devices should be provided while a MCB acting as the circuit protective device is considered **NOT** able to serve such propose.

**Figure 5.5.4: Separate control for Ordinance-applicable lighting and Ordinance non-applicable lighting**



5.5.5 Non-applicable lighting installation to the lighting control point requirement (BEC clause 5.5.5)

Given any space with its lighting installation that is designed for 24-hour a day, 7-day a week operation, the requirement on lighting control point is not applicable. Typical examples are the lighting serving residential common corridors, the entrance lobby of residential / hotel building etc. Instead, BEC clause 5.5.5 prescribes that the exception on lighting control point is **not** applicable to carpark.

5.6 Automatic Lighting Control (BEC clause 5.6 and BEC Table 5.4)

(a) BEC clause 5.6 specifies the technical requirement on automatic lighting control for all spaces as identified in BEC Table 5.4 (the 3<sup>rd</sup> column at the right refers). The requirement aims to minimize the energy consumption of artificial lighting in individual spaces by controlling the lighting output when there is no occupant, or out of the normal operation hours or when sufficient natural lighting (daylight) is available.


- (b) The system design and devices selection of automatic lighting control are under the REA/designer's responsibility in accordance with the space occupancy characteristic and operation patterns etc. Some international recognized standards such as ASHRAE 90.1, CIBSE Guide F, and Guide H etc., provides guidance on the basic technologies, the pros and cons of various lighting control strategies and are therefore the good design reference to the designer/ REA.
- (c) For the case where the developer decides to have bare shell provision only at the tenant space, it is acceptable to exclude the associated automatic lighting control from the stage two declaration submission. However, document proof, such as tenancy agreement, must be submitted also to demonstrate that the scope will be undertaken by the future tenant. Alternatively, if the developer provides centralized automatic lighting control system through, for instance, the building management system (BMS) but leave the wiring connections works by the future tenant, the system design and the details of the various components under the developer's scope including the interfacing details etc. should be covered by the stage two declaration submission.

#### 5.6.1 Basic Provision

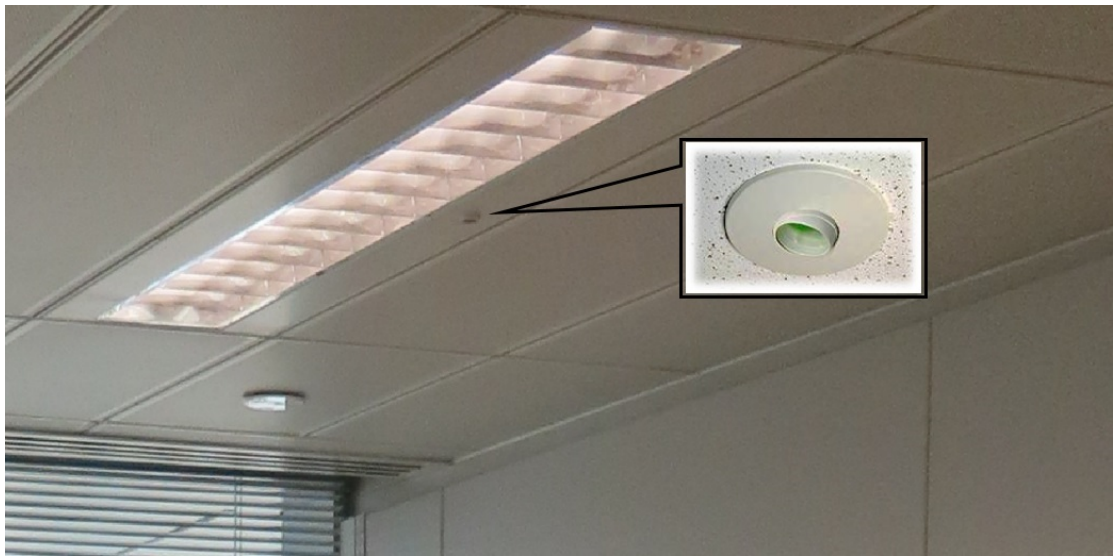
(a) The Applicability

- i) The spaces, as tabulated in BEC Table 5.4, with the total electrical power consumed by the fixed lighting installation in the space exceeding 150W should be provided with automatic lighting control system in such a way of shutting down or dimming the lighting as prescribed under BEC clause 5.6.1.1. The control devices or system may take place in form of daylight control, occupant sensor and automatic time scheduling or a combination of control device/system etc.
- ii) BEC clause 5.6.1.2 further specifies that for any space being identified to be governed under the requirement of automatic lighting control under BEC clause 5.6.1.1, such space if provided with fenestrations on external wall or overhead skylight should also be equipped with daylight responsive control.
- iii) Attention is drawn to the applicability to lift car lighting, the requirement of lighting control point (BEC clause 5.5.1) is not applicable to lighting installation within lift car. On the other hand, the exception on automatic lighting control (BEC clause 5.6.1.1) is not applicable to lift car lighting and the control of lift car control should comply with BEC clause 8.5.6.

- iv) Examples below further elaborate the available common technologies of automatic lighting control:-

<b><u>Table 5.6.1 (a): Occupant Sensor</u></b>	
	<p>Occupant sensor reduces lighting energy by switching off the lighting automatically in an unoccupied space after a certain period of time.</p> <p>Most devices can be calibrated for sensitivity and for the length-of-time delay between the last detected occupancy and switching off the lights. When the devices are capable of tuning lighting on &amp; off automatically, as a good engineering practice on maximizing the saving, "auto on" is not encouraged.</p> <p>Nowadays, technology such as passive infrared (PIR) / ultrasonic sensor/ microphonic detectors and sensor with dual technology are commonly found in the market. Occupant sensor is commonly adopted in private office, conference / training room, classroom &amp; store room etc. where occupancy is sporadic or unpredictable</p>

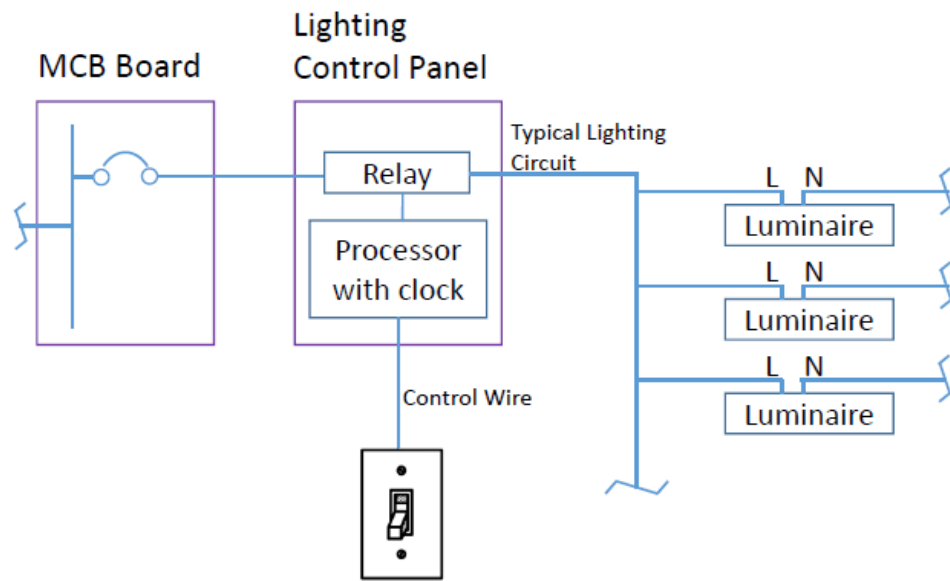
**Table 5.6.1 (b): Daylight Sensor (Photo Sensor)**



Photocell is used to measure the ambient light level incorporating daylight influence, and automatically adjust the artificial lighting level of a single or a group of luminaires by switching on/off or dimming the interior lighting fittings to maintain the setting illuminance in a given space. Lighting system can be installed with dimmers to avoid abrupt change of lighting level. Under certain circumstances, manual overriding switches may be necessary when space functions or personal requirements change.

Photocell is commonly adopt in the perimeter lighting zone (near the fenestration) or the overhead skylight, where daylight is available, e.g. office, clubhouse, entrance area/lobby etc.

**Table 5.6.1 (c): Automatic Time Scheduling**

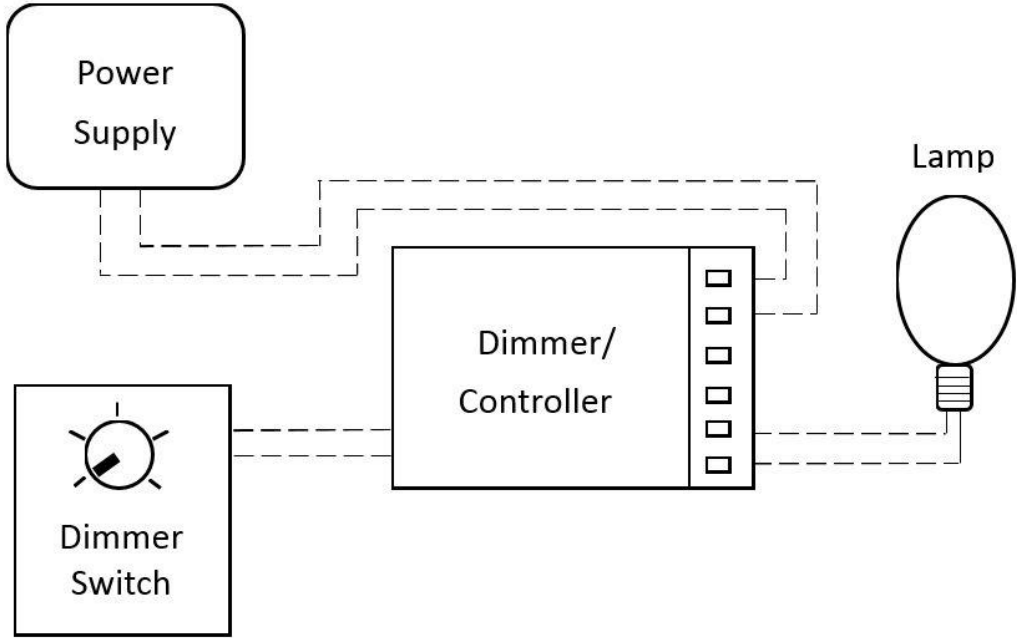


Automatic time scheduling system can be adopted for switching off the lighting in terms of time setting such as after daily operation hours, weekend etc. This requires a predictable operating schedule to avoid affecting the occupants during normal operation hours. These methods can be used effectively in spaces where the occupancy patterns are relatively regular or where the lighting operating hours are easy to predict, such as open plan office, circulation arcade of shopping mall, etc.

An automatic time scheduling system typically employs the following components:

- A central processor is usually capable of controlling several output channels, each of which may be assigned to one or more lighting circuits.
- Relays are series-wired to lighting control zones and are controlled by the central processor.
- Overrides, if provided, allow the occupant to use the space during scheduled off hours.

The control schedule can also be implemented via Building Management System for automatic control with manual override control to suit changes in occupancy / function.

<u>Table 5.6.1 (d) : Dimmer Control System</u>	
 <p>The diagram illustrates a dimmer control system. It consists of four main components: a Power Supply (top left), a Dimmer Switch (bottom left), a Dimmer/Controller (center), and a Lamp (right). Dashed lines represent the electrical connections between these components. The Power Supply is connected to the Dimmer/Controller. The Dimmer Switch is also connected to the Dimmer/Controller. The Dimmer/Controller is connected to the Lamp. The Lamp is represented by a standard incandescent bulb symbol.</p>	
<p>The use of energy is reduced when the lighting source is dimmed. Typically, a dimming control system includes a sensing element to monitor lighting level, a signal processor, and electronic dimming ballasts, which alter the current to the lamps (lighting source) in response to the signal coming from the processor. Nowadays, electronic dimming ballast and electronic LED driver are commonly adopted for the fluorescent and LED light respectively.</p> <p>When the dimming device is adopted, the dimmer loss or ballast loss should be taken into account on the circuit wattage calculation.</p>	

(b) The Control Devices and System

- (i) BEC clause 5.6.1.3 prescribes the performance requirements of an automatic time scheduling system. The system should be programmable to cope with the operation schedule of weekdays, weekend and public holidays. When automatic time scheduling system is deployed, the requirement on providing manual override control is not mandatory but under the sole discretion of the designer.

- (ii) Instead, once the system is incorporated with manual override control, the limits about the 2-hour activation time and the 500 m<sup>2</sup> under BEC clause 5.6.1.4 become mandatory. The overriding control device allows the occupants to use the space during scheduled off hours. Individuals can active the override by using personal-computer-based software prompts, or use telephone overrides to regain temporary control of the lights in a given space.
- (iii) BEC clause 5.6.1.5 prescribes the performance requirements of occupant sensor. The activation time of occupant sensor should be within 15 minutes (10 minutes for Carpark) when detects no presence of any occupant. Proper selection of sensor to suit the space environment is needed to avoid the false tripping. It is also recommended to adopt dual technology sensor / multi sensor for the space especially with low motion level such as typing, writing office etc. to minimize the effect to occupant.

Proper sensor technology and installation location should be selected with respect to the space requirement to avoid false tripping. In general, infrared type sensors are not sensitive to relatively small movement, such as typing on a keyboard. However, ultrasonic sensors can detect small movements and do not require a direct line of sight to occupants, but wind-blown curtains or papers can trigger the sensor incorrectly. New generation of occupancy sensor utilize both infrared and ultrasonic technology for maximum reliability and coverage with a minimum of false triggers. Another new technology incorporates a microphonic sensor, which "listen" for minute sounds, such as turning of pages, even though an occupant would not show any appreciable movement in the room.

As a good practice, shorter activation time should be allowed to enable control in a more responsive manner. Moreover, for spaces which are not normally occupied, or occupied by demand, such as toilet or meeting room, part of the lighting should be switched off or dimmed. Step control is recommended to minimize nuisance.

- (iv) BEC clause 5.6.1.6 specifies that automatic lighting control should not be applicable for the spaces occupied in 24 hours a day and 7 days a week, such as security guard counter, nurse duty centre, police reporting room with full-time attendant throughout a day and year around. However, the main entrance, lift lobby and corridor which is in transient-stay nature and without full-time occupant is not considered as spaces occupied in 24 hours a day and 7 days a week.

5.6.2 Daylight responsive control for daylight through fenestrations on exterior wall (BEC clause 5.6.2)

**Figure 5.6.2 (i) : Daylight Control Zone through Fenestration on External Wall**

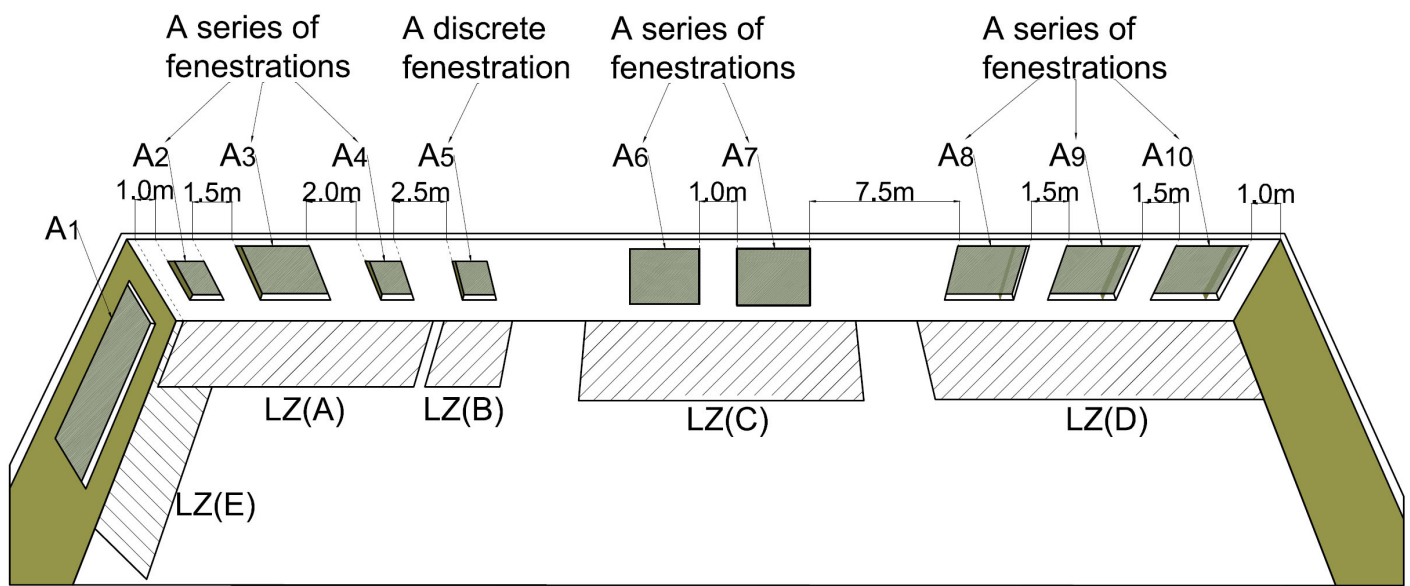
When sum of  $A_1$  to  $A_{10} \geq 5m^2$ , assign a lighting zone to each discrete fenestration / series of fenestrations (BEC Clause 5.6.2.1)

Derive area of each lighting zone in accordance with BEC Clause 5.6.2.2:

where,  $LZ(A) \geq 2 \times (A_2+A_3+A_4)m^2$ ;  $LZ(B) \geq 2 \times (A_5)m^2$ ;  $LZ(C) \geq 2 \times (A_6+A_7)m^2$ ;

and  $LZ(D) \geq 2 \times (A_8+A_9+A_{10})m^2$

When  $A_1 \geq 5m^2$ , it is a discrete fenestration not at the same orientation as  $A_2$  to  $A_{10}$ . It should be assigned with a lighting zone  $LZ(E) \geq 2 \times (A_1)m^2$ . The overlapped lighting zone area may be controlled under  $LZ(A)$ .



(a) Lighting Zone

- (i) TG Figure 5.6.2 (i) presents a space that should be provided with automatic lighting control as identified under BEC Table 5.4. Given the fact that the sum of the area of fenestration on exterior walls exceeds  $5m^2$  (BEC clause 5.6.2.1), the requirements on daylight responsive control are applicable to the space.
- (ii) Fenestration A2, A3 & A4 are on the same orientation with separation less than 2m and are regarded as a series of fenestration (BEC clause 5.6.2.4). Similarly, A6 and A7 are considered also as a series of fenestrations.
- (iii) Fenestration A5 being separated from the adjoining fenestration exceeding 2m, it is a discrete fenestration. Fenestration A1, being location on different orientation is regarded as a discrete fenestration also.



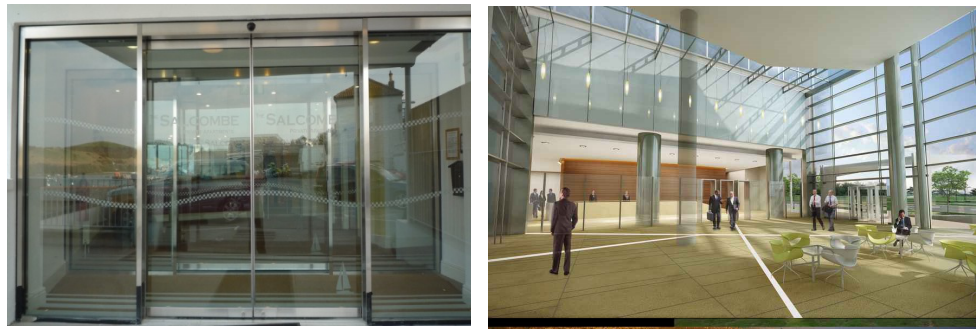
- (iv) Each of the discrete fenestration & a series of fenestration should be assigned with the corresponding lighting zone (BEC clause 5.6.2.1). For example, lighting zone LZ(B) is assigned under the discrete fenestration A5. Area of LZ(B) should be at least twice the area of A5 (BEC clause 5.6.2.2 (a)). LZ(D) being assigned under a series of fenestration (A8 to A10) should have its area at least twice the sum of the areas of A8, A9 & A10 (BEC clause 5.6.2.2 (b)).
- (v) A portion of lighting zone LZ(E) (assigned under A1) overlaps with LZ(A) (assigned under A2 to A4). Those lighting fittings at the overlapped light zone can be controlled by the device under either LZ(A) or LZ(E).

(b) Fenestration on exterior wall (BEC clause 5.6.1.2 & 5.6.2.1)

The fenestration on exterior wall and the area requirement as prescribed in the above BEC clause means windows, glazing etc. and the applicable examples are shown in TG Table 5.6.2 (i).

(c) Exception

The requirement on the daylight responsive control is not applicable to the fenestration with non-see-through type glazing, as prescribes under BEC clause 5.6.2.5 (a). TG Table 5.6.2(ii) illustrate the examples of no-see-through glazing.

<b><u>Table 5.6.2(i) : Applicable examples - fenestration on exterior wall</u></b>	
(a)	<p>Glazed entrance doors, full height glazed wall</p> 

(b) Recessed window on external wall



**Table 5.6.2(ii) : Examples of non-see-through glazing**

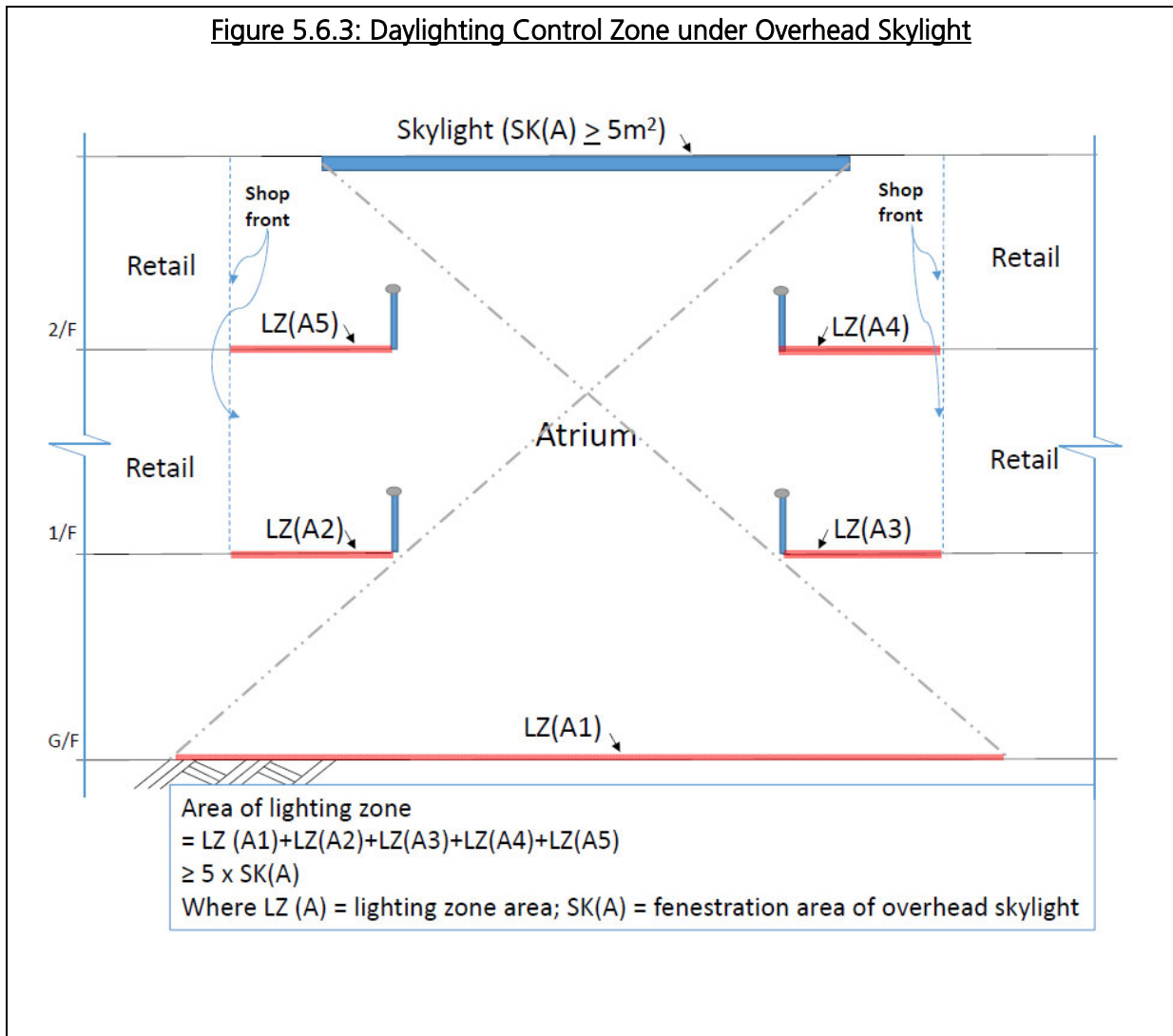


(d) Lighting zones on multiple floors (BEC clause 5.6.2.6)

- (i) A single daylight responsive control device is allowed to serve the lighting zones at multiple floors provided that the conditions as prescribed under BEC clause 5.6.2.6 are complied with.
- (ii) Given a hotel building, for example, consider that the each of the passenger lift lobby on the typical floors is provided with side fenestration exceeding 5m<sup>2</sup>. The layout of each passenger lift lobby and the configuration of lighting installation are the same. As such, applying single daylight responsive control device serving lighting zones on multiple floors is permissible. However, attention is to drawn to the fact that the daylight factor available on higher floors may not be the same as that on the lower floors where the sunlight is blocked by the buildings nearby. Thus, the REA/designer should justify the grouping of lighting zones at multiple floors taking into account also the building orientation and influence from surrounding buildings.

5.6.3 Daylight responsive control for daylight through overhead skylight (BEC clause 5.6.3)

TG Figure 5.6.3 below illustrates the lighting zone arrangement under an overhead skylight of an atrium. The total fenestration area of skylight SK(A) is assumed exceeding 5m<sup>2</sup>. The lighting zones assigned under the skylight can be allocated on more than one floors in such a way the sum of the area of the lighting zone LZ(A1), LZ(A2), LZ(A3), LZ(A4) and LZ(A5) should be at least five (5) times of SK(A) (BEC clause 5.6.3.2).



5.7 Sample Calculation

Multi-functional Space

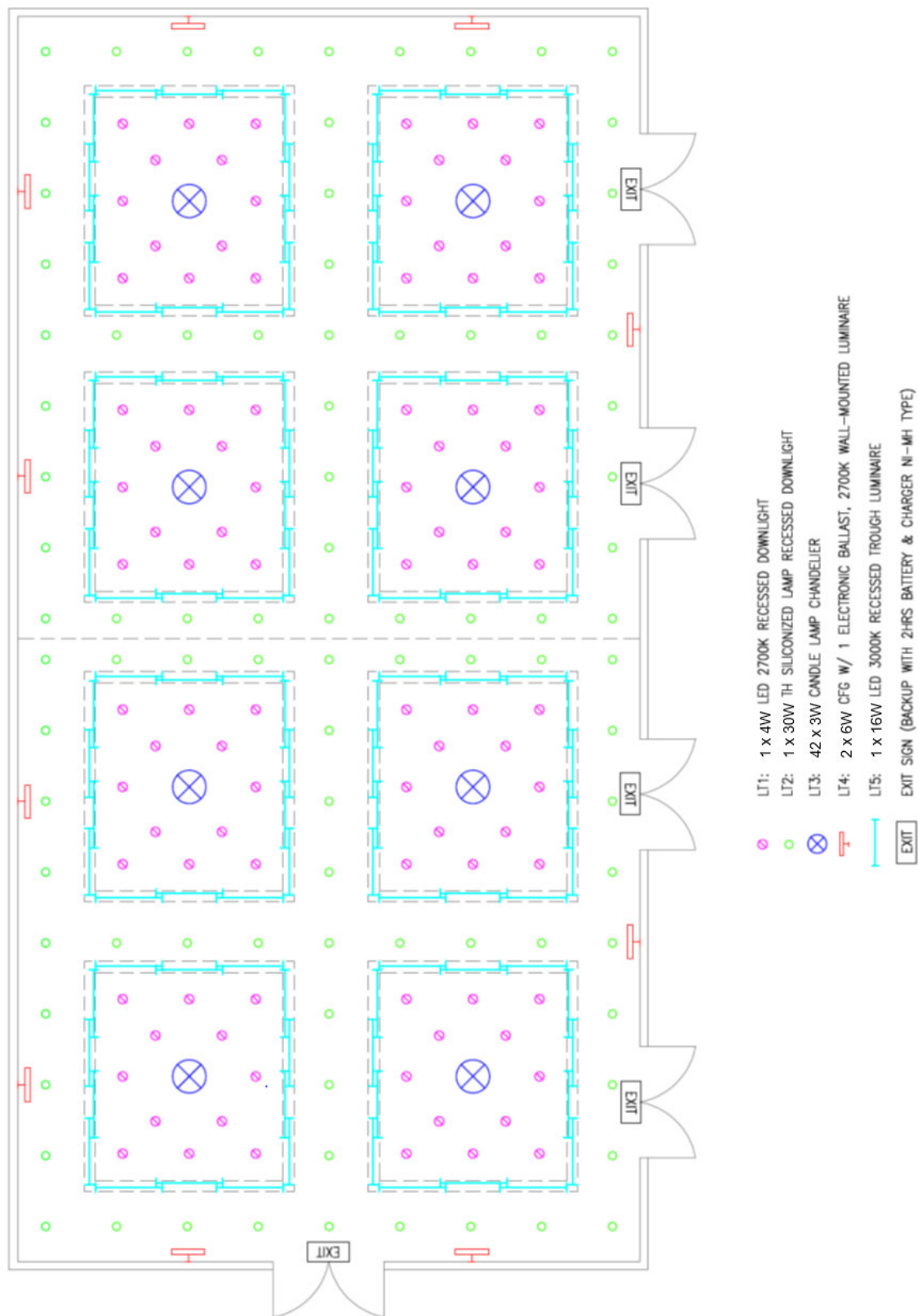
The lighting layout of a hotel’s multi-functional space with 264 m<sup>2</sup> (measured 22 m by 12 m) internal floor area is shown in TG Figure 5.7. The room can be used either as a banquet room, a ball room or a seminar room. The room is served by luminaire types LT1, LT2, LT3, LT4 and LT5, with the following luminaire circuit wattage –

<u>Luminaire Designation</u>	LT1	LT2	LT3	LT4	LT5
<u>Per Luminaire Circuit Wattage (W)</u>	5	32	138	14	18
Remark : LT4 is solely used to provide a wall wash effect or to illuminate wall mounted painting. LT1 & LT2 mainly serve as general lighting, and LT3 serves both as general lighting and for decoration.					

TG Table 5.7 below shows the calculation of LPD (based on LPD standards of Initial version) for each of the three functions.

<b>Table 5.7 : LPD Calculation for Multi-functional Space</b>					
<u>Space</u>	<u>Function-specific Luminaires</u>			<u>LPD (W/m<sup>2</sup>)</u>	
<u>Function</u>	<u>Luminaire Designation</u>	<u>Quantity</u>	<u>Total Circuit Wattage (W)</u>	<u>Calculated</u>	<u>Max Allowable</u>
Banquet room	LT1	96	480	[480 + 2880 + 1104] / 264 = 16.9	17.0
	LT2	90	2880		
	LT3	8	1104		
	LT4	Excluded in LPD			
Ball room	LT2	90	2880	[2880 + 1104] / 264 = 15.1	17.0
	LT3	8	1104		
	LT4	Excluded in LPD			
Seminar room	LT1	96	480	[480 + 2016] / 264 = 9.5	12.8
	LT5	112	2016		

Figure 5.7: Lighting layout of a multi-functional space in a hotel



## 6. Energy Efficiency Requirements for Air-conditioning Installation

### 6.1 Scope of Application (BEC clause 6.1)

#### 6.1.1 Comprehensive View on Applicability (BEC clause 6.1.1)

BEC Section 6 provides the guidelines for air-conditioning installations. To gain a comprehensive view in relation to the Ordinance, BEC clause 6.1 should be read in conjunction with –

- BEC Sections 3 & 4 that briefly describe the scope and limits of the application of the Ordinance based on its prescribed requirements in Parts 2 & 3; and
- TG Sections 3 & 4 that elaborate on the scope and limits of application and the necessary steps to demonstrate the compliance with the Ordinance and the BEC.

For reference, the interpretation of ‘air-conditioning installation’ under the Ordinance and the BEC is extracted below -

‘Air-conditioning installation’, in relation to a building, means fixed equipment, distribution network or control devices that cool down, heat up, humidify, dehumidify, purify or distribute air within the building;

#### 6.1.2 Examples of BEC Applicable Installations (BEC clause 6.1.2)

In respect of certain types of air-conditioning installations, BEC clause 6.1.2 affirms for the avoidance of doubt the Ordinance’s applicability to these installations, and examples thereof are given in TG Table 6.1.2 below.

<b><u>Table 6.1.2 : Examples of BEC Applicable Air-conditioning Installations</u></b>	
<u>Examples</u>	<u>Justifications</u>
Smoke extract fan serving basement, used for general exhaust during normal operation and for smoke extract during fire mode	BEC clause 6.1.2 (a)
Split type air-conditioner above and serving a lift car	BEC clause 6.1.2 (b)
A split type air-conditioner, owned by the occupier or responsible person of a space in the building, having an indoor unit within and serving the space but with outdoor unit mounted outside the building boundary	BEC clause 6.1.2 (c)
Chilled water plant being accommodated in a remote standalone plantroom serving a prescribed building.	BEC clause 6.1.2 (c)

### 6.1.3 Examples of BEC Non-applicable Installations (BEC clause 6.1.3)

BEC clause 6.1.3 lists certain air-conditioning installations to which the Ordinance does not apply, and examples of these installations are given in TG Table 6.1.3 below.

<b><u>Table 6.1.3 : Examples of BEC Non-applicable Air-conditioning Installations</u></b>	
<u>Examples</u>	<u>Justifications</u>
Chiller operating at high electrical voltage of 3.3 kV	BEC clause 6.1.3(a)
Air handling unit solely used for surgical operation in operating theatre in a hospital	BEC clause 6.1.3(b) (fulfilling item 2(a), Schedule 2 of the Ordinance)
Smoke extract fan serving basement described in TG Table 3.3	described in TG Table 3.3
Exhaust fan for fume cupboard solely for research in a university (and not for other purpose)	BEC clause 6.1.3(b) (fulfilling item 5, Schedule 2 of the Ordinance)

### 6.2 General Approach (BEC clause 6.2)

The energy efficiency requirements in BEC clauses 6.4 to 6.14 are based on the general approach to energy efficiency given in BEC clause 6.2.

### 6.3 Definitions (BEC clause 6.3)

BEC Section 2 provides the interpretations and abbreviations related to the BEC and the Ordinance, including those for air-conditioning installation.

### 6.4 System Load Calculation (BEC clause 6.4)

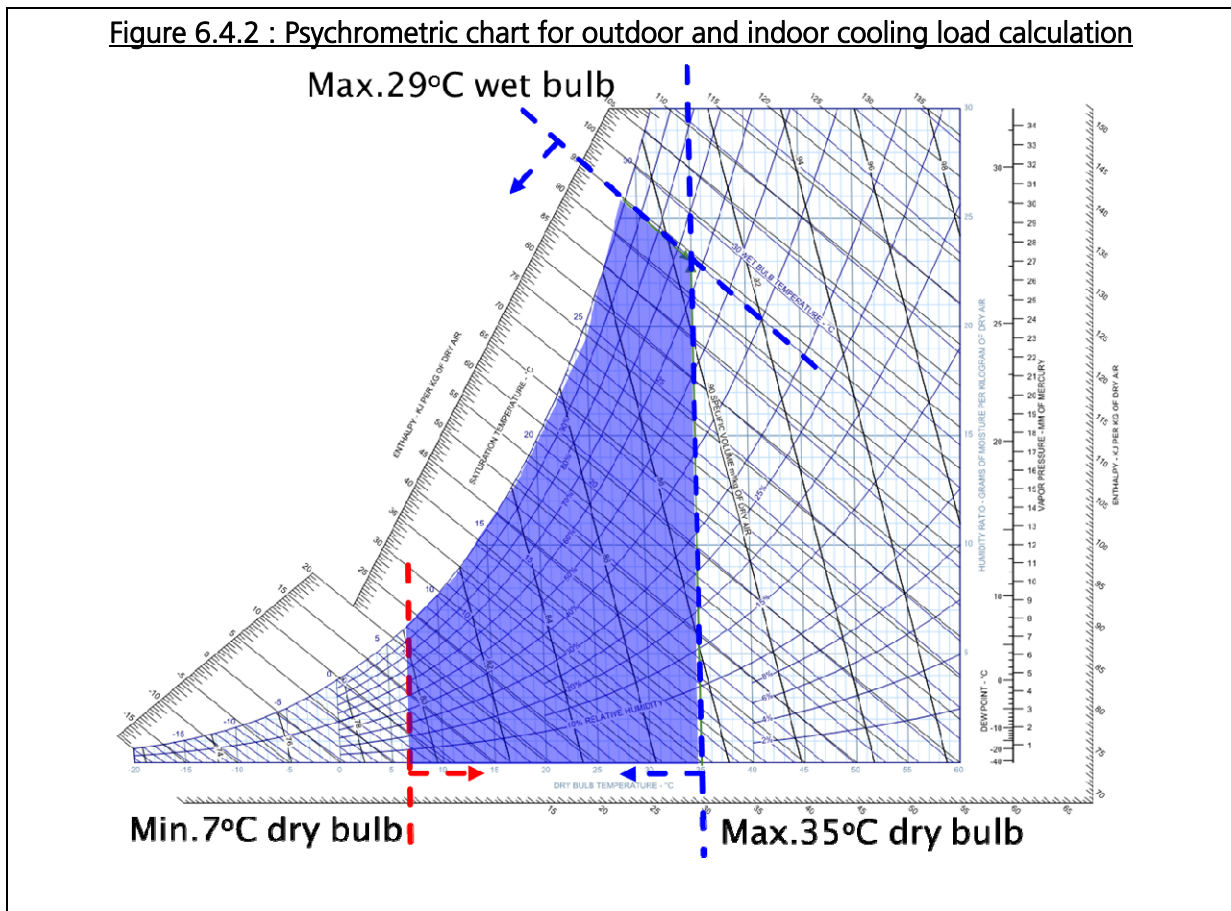
#### 6.4.1 International Recognized Procedures (BEC clause 6.4.1)

The BEC specifies that the cooling/heating load calculations should be in accordance with international recognized procedures and methods such as described in ASHRAE Handbook Fundamentals, CIBSE Guide A etc., which are widely adopted by REA/designers.

#### 6.4.2 System Load Design Conditions (BEC clause 6.4.2)

The inclusion of load design conditions in BEC Table 6.4 is for purpose of avoiding over estimation that will lead to over-sizing of system and equipment. The figures in the table are the points bounding the compliance range within which the design conditions for

load calculation should be allocated. For outdoor summer, the REA/designer can choose between two design conditions: 35°C dry bulb with lower than 29°C wet bulb, or 29°C wet bulb with lower than 35°C dry bulb, the former condition suiting a zone being dominant by sensible heat loads and the latter a zone being dominant by latent heat loads. Typical examples of space dominant by sensible heat loads and latent heat loads are typical offices and gymnasiums respectively. In general, spaces with large number of occupants will have higher latent load requirement due to large amount of fresh air supply. The outdoor design conditions are applicable to all types of applications, while the indoor design conditions are confined to human comfort applications. Examples of non-human comfort applications are data centre, wine cellar (maintaining a lower temperature range e.g. 10-16°C at dedicated range of relative humidity), pathology room (maintaining a higher temperature e.g. 37°C to boost bacteria growth) etc. The psychrometric chart below illustrates the boundaries comparing against the typical outdoor and indoor conditions for cooling load calculation:



Similar for outdoor condition, the REA/designer can choose the design condition for indoor by not exceeding the limit stated in BEC Figure 6.4.2. Example of an indoor condition in summer is dry bulb temperature of 24°C and relative humidity of 65% for office application.



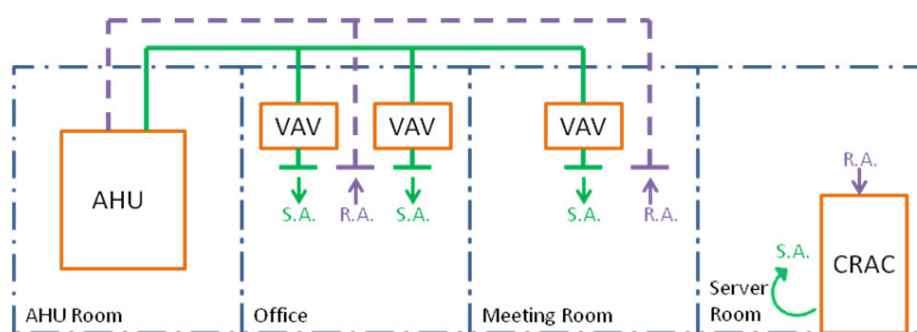
6.5 Separate Air Distribution System for Process Zone (BEC clause 6.5)

A process zone and a comfort only zone have different temperature and humidity requirements and operating characteristics, and the BEC requires the process zone to have an air distribution system separate from that of the comfort zone. The separate air distribution system requirement offers the benefit of better room condition control in the two different types of zone, and avoids unnecessary recooling or reheating.

6.5.1 Example of Separate Air Distribution System (BEC clause 6.5.1)

An example of a process zone is the computer server room with special temperature and humidity requirements. As shown in TG Figure 6.5.1 below, the process zone - the Server Room, is served by a computer room air conditioning unit (CRAC), and its adjoining spaces of Office and Meeting Room - the comfort only zone, is served by variable air volume (VAV) units in conjunction with an AHU located in an AHU room.

**Figure 6.5.1: Separate air distribution system for computer Server Room**

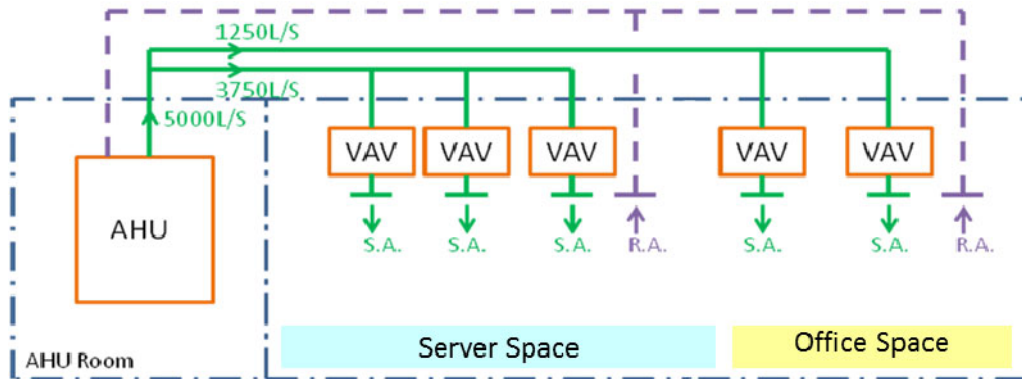


6.5.2 Exemption from Requirement of Separate Air Distribution System (BEC clause 6.5.2)

Providing the zoning flexibility for small air-conditioning systems, BEC clause 6.5.2 gives the following conditions under which the process zone and comfort only zone can share a common air distribution system -

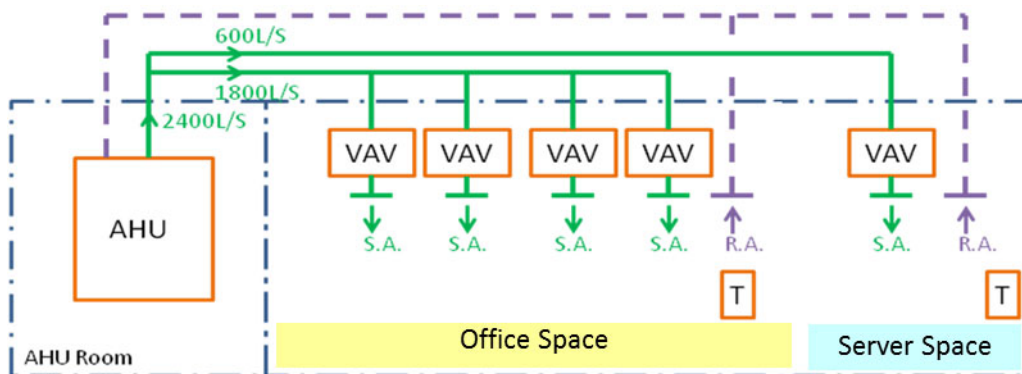
- (a) the supply air to the comfort only zone is no more than 25% of the total air flow of the common air distribution system, as shown in the scenario in Figure 6.5.2 (a) below, which has the supply air to the Office space at 1250 L/s or 25% of the total supply air flow of 5000 L/s; or

**Figure 6.5.2 (a): Supply air to comfort zone no more than 25% of total air flow**



- (b) the comfort only zone has a small conditioned area of smaller than 100 m<sup>2</sup>, which is typical for a small office having very few occupants within a server room, or
- (c) the supply air to the process zone is no more than 25% of the total air flow of the common system, as shown in the scenario in TG Figure 6.5.2 (c) below, which has the supply air to the Server space at 600 L/s or 25% of the total supply air of 2400 L/s, and the process zone has separate room temperature control and requires no reheat of the common system supply air.

**Figure 6.5.2 (c): Supply air to process zone no more than 25% of total air flow**



The exemptions are to provide the flexibility for designing minor auxiliary spaces within a principal space, such as a server room set-up easily accommodating a small office space, and vice versa.

#### 6.6 Air Distribution Ductwork Leakage Limit (BEC clause 6.6)

BEC Table 6.6 specifies the maximum allowable air leakage limits of ductwork that is designed to operate in excess of 750 Pa static pressure. The leakage limits are based on equations in DW 143 – A Practical Guide to Ductwork Leakage Testing (2000) published by Heating and Ventilating Contractors’ Association, UK. Static pressure of 750 Pa is commonly found in VAV ductwork systems, which are usually equipped with dampers to modulate the air flow in response to thermostatic sensing, and these dampers add resistance to the air flow. Ductwork are classified in terms of increasing operating static pressure into three classes namely Class I, Class II and Class III. Each class

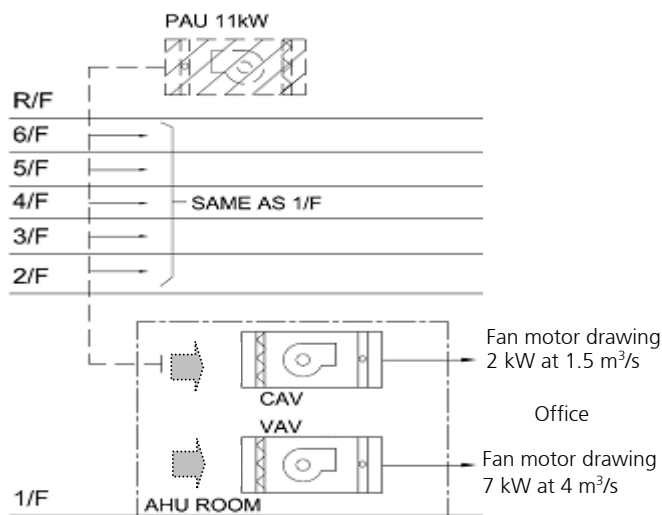
is assigned an equation based on which the allowable air leakage limit is calculated, such that the allowable leakage gets more stringent with the advancement from a lower class to a higher class that associates with a higher operating pressure.

6.7 Air Distribution System Fan Power (BEC clause 6.7)

(a) Maximum Allowable System Fan Motor Power (BEC clauses 6.7.1 to 6.7.3)

- i) BEC clauses 6.7.1 to 6.7.3 specify for a conditioned space the requirements on maximum allowable system fan motor power, of the air distribution system, the calculation of which includes the supply air fan and return air fan but not the fresh air fan and exhaust air fan. The requirements are not applicable to air distribution systems in unconditioned spaces. The motor power refers to the power drawn by the fan motor, when the AHU fan and its serving equipment in particular the coils are at clean condition; the power drawn by the fan motor is usually lower than the motor’s rated output power (shown on motor name plate) but higher than the actual power delivered by the fan. The VAV system given it drawing a lower motor power at part load is allowed a higher system fan power of 2.1 W/L/s whereas the constant air volume (CAV) is allowed 1.6 W/L/s.
- ii) Calculation of system fan motor power ( $P_T$ ) for a system with supply air fan only

**Figure 6.7 (a) : Illustration of system fan motor power**



An illustration of a simple calculation of system fan motor power is shown in TG Figure 6.7(a). The figure shows two air distribution systems serving an office on 1/F, the CAV and the VAV systems, comprising respectively of a CAV AHU with its fan motor drawing 2 kW electrical power when delivering an air flow of 1.5 m³/s and a VAV AHU with its fan motor drawing 7 kW electrical power when delivering an air flow of 4 m³/s.

System fan motor power for VAV = 7 kW / 4 m<sup>3</sup>/s = 1.75 W/L/s

System fan motor power for CAV = 2 kW / 1.5 m<sup>3</sup>/s = 1.33 W/L/s; the 1.6 W/L/s requirement does not apply, given the system fan motor power of 2 kW falling within the exemption criterion of less than 2.5 kW as described in TG clause 6.7(c) below.

The primary air AHU (PAU) and exhaust fans if any need not be included in the calculation of system fan motor power.

- iii) Fan motor power can also be determined based on fan curves that relate air flow to fan shaft power (FSP), for which the fan motor power can be calculated by first dividing the fan shaft power by the motor efficiency ( $\eta_m$ ) and then by the efficiency of the mechanical drive ( $\eta_d$ , such as fan pulley/belt). An illustration of the calculation is shown in the latter part of (b) ii) below.
- iv) The example in TG clause 6.7(a) ii) has no return air fan, which if in place its fan motor power per L/s has to be added to that of the supply air fan, and the sum of the addition would be the total system fan motor power ( $P_T$ ) for comparison with the 1.6 or 2.1 W/L/s figure. An illustration of the calculation with a return air fan is shown in the latter part of (b) ii) below.

(b) Pressure Drop for Air Treatment or Filtering (BEC clause 6.7.3)

- i) Air treatment such as heat wheel or heat exchanger and filtering systems may cause higher pressure drop in an air distribution system. The BEC recognizes the benefits of air treatment to indoor air quality and provides a clause for 'deductible' fan power to minimize the penalties on fan motor power brought on by air treatment equipment. BEC clause 6.7.3 allows the system pressure drop at clean condition caused by air treatment or filtering systems that exceeds 250 Pa to be deducted from the system fan motor power. The deductible fan motor power can be calculated using the following equation -

$$P_f = V \times (p_d - 250) / (\eta_m \times \eta_f \times \eta_d)$$

where

$P_f$  = Deductible fan motor power for air treatment/filtering (W) in excess of 250 Pa

$V$  = Air volume flow rate (m<sup>3</sup>/s)

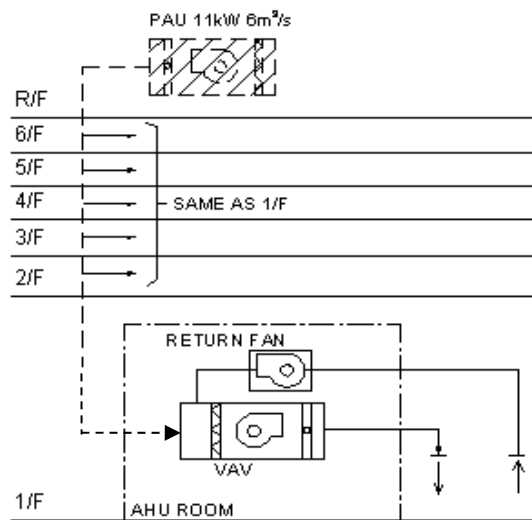
$p_d$  = Air pressure drop (Pa) of the treatment/filtering system and/or heat wheel/exchanger system in clean condition

$\eta_m$  = Motor efficiency     $\eta_d$  = Drive/belt efficiency     $\eta_f$  = Fan efficiency

ii) Example Illustrating Deductible Fan Motor Power and System Fan Motor Power

Consider a VAV system having a supply air AHU and a return air fan in TG Figure 6.7(b). The fan shaft power  $FSP_S$  of the AHU is 7kW at the design flow of  $5.5\text{m}^3/\text{s}$ , and the fan shaft power  $FSP_R$  of the return air fan is 4kW at the design flow of  $3.5\text{m}^3/\text{s}$ . The total filter pressure drop ( $p_d$ ) including air bag filter, HEPA filter etc. is 450 Pa. The motor efficiency, drive/belt efficiency and fan efficiency of the supply fan is 0.92, 0.97 and 0.8 respectively, and the same of the return fan is 0.9, 0.97 and 0.7 respectively.

**Figure 6.7 (b) : Illustration of deductible fan motor power**



Calculation of deductible fan motor power

$$p_d = 450 \text{ Pa} \quad V = 5.5\text{m}^3/\text{s} \quad \eta_m = 0.92 \quad \eta_d = 0.97 \quad \eta_f = 0.8$$

$$P_f = V \times (p_d - 250) / (\eta_m \times \eta_d \times \eta_f) = 5.5 \times (450 - 250) / (0.92 \times 0.97 \times 0.8)$$

$$= 1,541 \text{ W or } 1.54 \text{ kW}$$

Calculation of system fan motor power ( $P_T$ ) for a system with supply and return air fans and deductible fan motor power

$$P_T = FSP_S / (\eta_m \times \eta_d) - P_f + FSP_R / (\eta_m \times \eta_d)$$

$$= [7 / (0.92 \times 0.97)] - 1.54 + [4 / (0.9 \times 0.97)] \text{ kW}$$

$$= 7.84 - 1.54 + 4.58 \text{ kW}$$

$$= 10.9 \text{ kW}$$

$$\text{System fan motor power} = P_T / V = 10.9 / 5.5 \text{ kW/m}^3/\text{s}$$

$$= 1.98 \text{ W/L/s, which fulfils the } 2.1 \text{ W/L/s requirement}$$

- (c) Exemption from Maximum Allowable System Fan Motor Power Requirements (BEC clause 6.7.5)

BEC clause 6.7.5 specifies the conditions under which the maximum allowable system fan motor power requirement can be exempted.

An exemption is by virtue of the system fan motor power being less than 2.5 kW. Take for example a VAV air distribution system having  $FSP_S$  of 2 kW,  $FSP_R$  of 0.8 kW, and  $P_f$  of 0.7 kW at the designed flow of 1.1 m<sup>3</sup>/s; the motor efficiency and drive/belt efficiency of the supply fan is 0.92 and 0.97 respectively, and of the return fan is 0.9 and 0.97 respectively.

$$\begin{aligned}
 P_T &= FSP_S / (\eta_m \times \eta_d) - P_f + FSP_R / (\eta_m \times \eta_d) \\
 &= [2 / (0.92 \times 0.97)] - 0.7 + [0.8 / (0.9 \times 0.97)] \text{ kW} \\
 &= 2.24 - 0.7 + 0.92 \text{ kW} \\
 &= 2.46 \text{ kW, and falls within the exemption range of 2.5 kW,} \\
 &\text{which if not exempted could give a system fan motor power of } 2.46 / 1.1 \text{ or } \\
 &2.24 \text{ W/L/s that does not fulfil the requirement of 2.1 W/L/s.}
 \end{aligned}$$

The other exemption is by virtue of the air distribution system comprising of FCUs only and each having motor power less than 1 kW.

- (d) Vary of Airflow to System Load (BEC clause 6.7.4)

BEC clause 6.7.4 specifies that an air-conditioning system should be designed to vary the airflow as a function of load by setting a reduced speed operation mode. Fan coil unit typically with fan motor power below 1.0 kW is not governed by this requirement.

CAV air distribution system should be provided with low-speed operation mode where the fan speed should be set not exceeding 66% of the full speed and the fan motor should draw no more than 40% of the full speed power. The requirement can be fulfilled by deploying two-speed motor.

VAV air distribution system should be provided with minimum fan speed not exceeding 50% of the full speed with the fan motor drawing no more than 30% of the full speed power at the minimum fan speed. This can be achieved by tuning down the motor speed via a frequency inverter type variable speed drive as demonstrated in TG Table 6.7.4 (attention should be paid to the inverter's generated harmonic currents which is discussed in TG Section 7). A reduction of fan power through throttling of air dampers, inlet guide vanes or two speed motor only may not achieve the 30% requirement.

**Table 6.7.4 : Illustration of VAV system fan motor power at minimum fan speed**

*Consider a VFD coupled to a motor that requires 16.4 kW to deliver 14.9 kW fan shaft power to a supply air fan when operated at its full rated speed. At half its rated operating speed, the fan delivers 50% of its rated airflow but requires only 1/8 full-load power. Even with a reduced motor efficiency of 77.8% and drive efficiency of 86%, with adjustable speed operation the power required by the fan and the VFD is only 2.8kW. For this example, input power requirements are reduced by 82.9%.*

$$kW \text{ at } 50\% = 14.9 \text{ kW} \times (1/2)^3 / (0.778 \times 0.86) = 2.8 \text{ kW}$$

If the air-conditioning system not be able to meet the fresh air requirement at reduced speed operation mode, the low speed operation of CAV air distribution system or the minimum fan speed of VAV air distribution system should be selected to provide the required fresh air rate as prescribed under BEC clause 6.7.4.3.

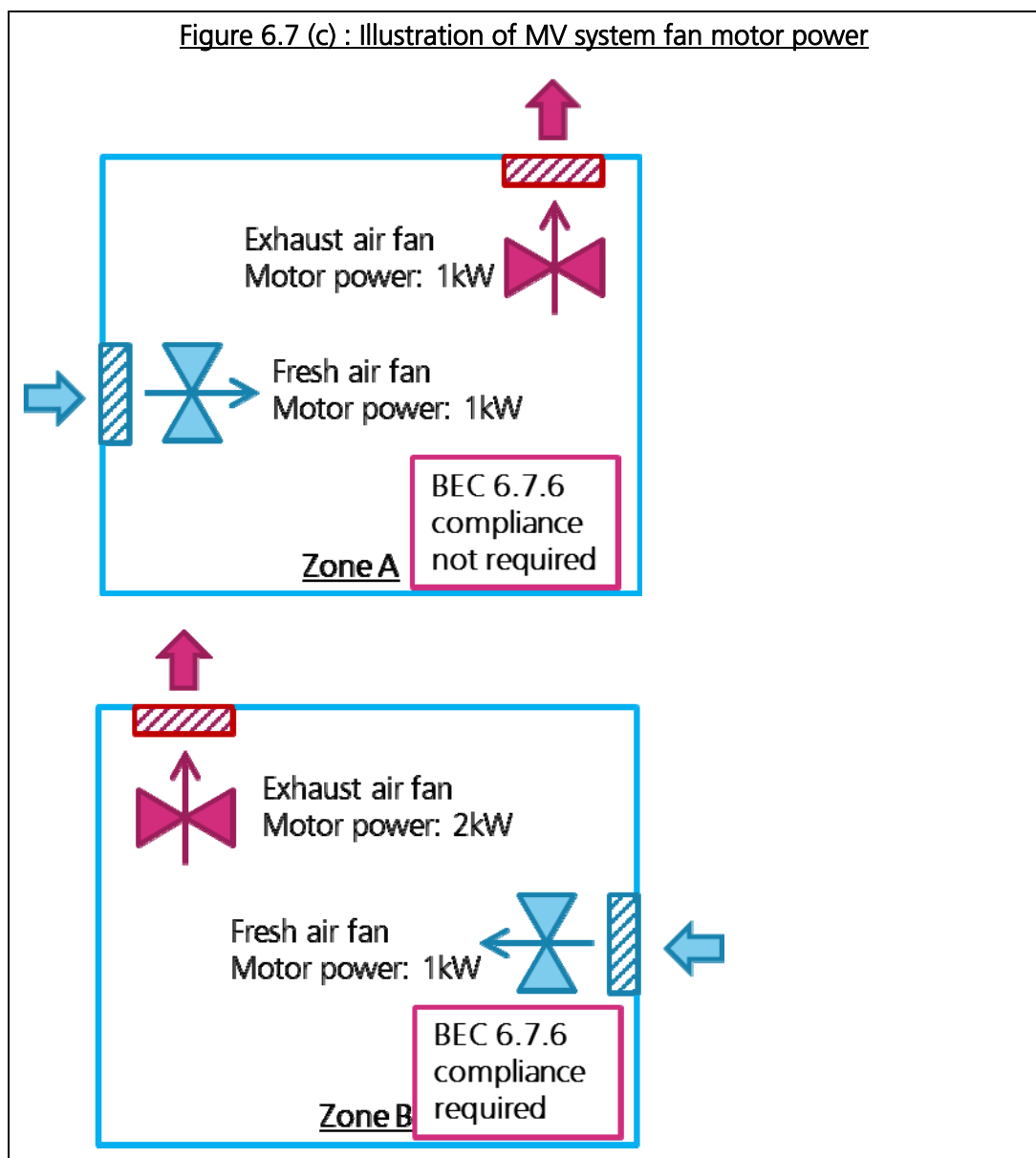
(e) Mechanical Ventilation System Fan Motor Power (BEC clause 6.7.6)

BEC clause 6.7.6 specifies the requirements on maximum allowable mechanical ventilation (MV) system fan motor power. This requirement deals with unconditioned spaces. The space in the BEC refers to a collective term of a group of spaces served by a mechanical ventilation system. For instance, exhaust fan(s) and the associated make-up air fan(s) at the roof top serving the toilets on the typical floors are governed under this requirement. The motor power refers to the power drawn by the ventilation fan motor. The calculation of which includes the fresh air fan (or make-up air fan) and the exhaust air fan.

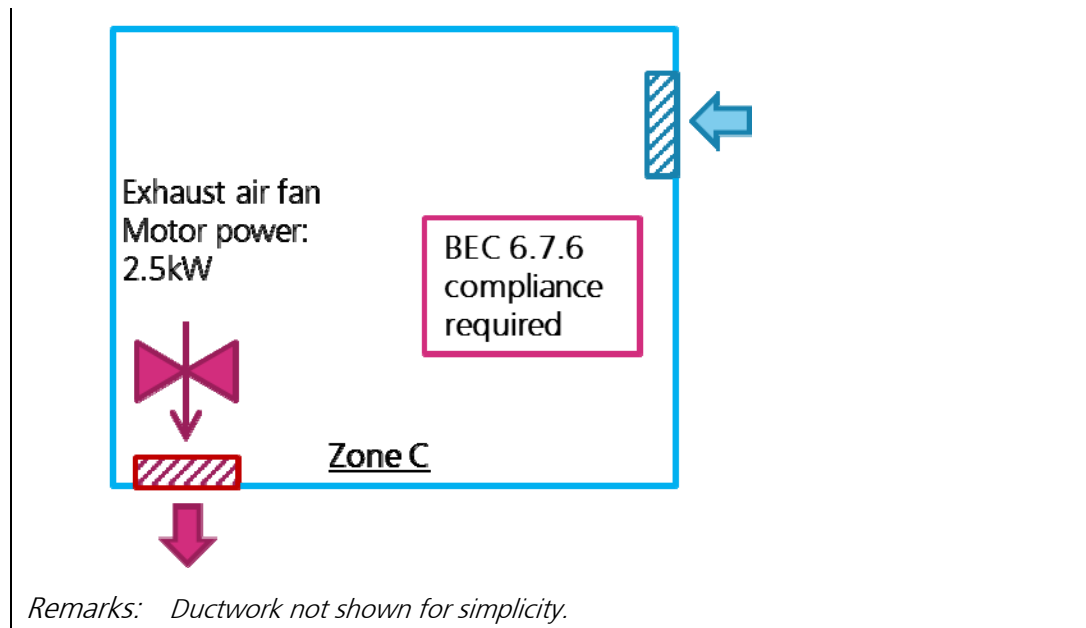
For carpark ventilation system with jet fans, the motor power of each jet fan should be included into the calculation of system fan power. Instead, any fans for the sole purpose of air recirculation could be excluded from the calculation.

Exception is given in BEC clause 6.7.6 that the requirement is not applicable to the MV system with system fan motor power less than 2.5kW. TG Table 6.7.6 and TG Figure 6.7 (c) illustrate the compliance with the requirements.

Area	Fresh air fan motor power (kW)	Exhaust air fan motor power (kW)	System fan motor power (kW)	Compliance with BEC 6.7.6
Zone A	1	1	2	Not Required
Zone B	1	2	3	Required
Zone C	N/A	2.5	2.5	Required







Air treatment device is crucial in a MV system and may cause significant pressure drop. BEC clause 6.7.6.1 allows the pressure drop across the air treatment or filtration device to be deductible from the system fan motor power. Care should be taken that the 250 Pa deductible as allowed in BEC clause 6.7.3 is not applicable to MV system.

- (a) Grease filter;
- (b) Hydrovent and air washer;
- (c) Baffle filter;
- (d) Activated carbon filter; and
- (e) Venturi scrubber

**Figure 6.7 (d) : Venturi scrubber**



## 6.8 Pumping System Variable Flow (BEC clause 6.8)

### 6.8.1 Applicability (BEC clause 6.8.1)

BEC clause 6.8.1 requires that if a water side pumping system is designed for variable flow in response to cooling/heating load and the variable flow is affected through the opening, closing or modulation of control valve(s), it should be capable of operating at 25% or less of the design flow. The variable flow requirement refers to the whole pumping system, which may consist of multiple pumps and chillers, and the flow reduction may be achieved by chiller and pump sequencing, valves on/off/modulation or reduced speed operation of variable/multi speed pumps. Manual operation to effect the sequencing, on/off/modulation or reduced speed is not regarded as fulfilling the requirement.

There are exemptions given under BEC clauses 6.8.1 (a), (b) and (c), from the 25% flow requirement. The exemption in 6.8.1 (a) and (b) and (c) may apply for certain small air-conditioning systems.

Here is an example of how to fulfill the BEC clause 6.8.1 requirement considering the chilled water pumping system consists of 1 number to 4 numbers of chiller(s) and pump(s):

No(s). of Chiller & pumps in the system	CH-1 & CHWP-1	CH-2 & CHWP-2	CH-3 & CHWP-3	CH-4 & CHWP-4	Capability of flow at individual chiller & pump	Achieved System Flow	Example of methods to fulfil the design flow in operation
1 set	25%				25%	25%	By adjusting speed on VSD pumps
2 set	Off	50%			50%	25%	By On/Off Chiller(s) & pump(s) plus adjusting speed on VSD pumps
3 set	Off	Off	75%		75%	25%	
4 set	Off	Off	Off	100%	100%	25%	By On/Off Chillers & pumps

**Remarks:** The design flow and operation of chiller(s) & pump(s) in the example above are for reference only. The actual system configuration and control logic of pumps & chillers subject to REA / Designer's engineering design.

6.8.2 Requirement for Variable Speed Pump (BEC clause 6.8.2)

BEC clause 6.8.2 specifies that any chilled water pump with motor output power exceeding 2.2kW should be of variable speed. The pump should operate at no more than 30% of design input power at 50% of design water flow through tuning down the motor speed via a frequency inverter type variable speed drive (attention should be paid to the inverter’s generated harmonic currents which is discussed in TG Section 7). A reduction of pump power through valves modulation only may not achieve the 30% requirement. The 30% requirement is not applicable to any motor output power at 2.2 kW or less.

6.8.3 Requirement on Chiller Isolation (BEC clause 6.8.3)

BEC clause 6.8.3 specifies that a chilled water plant consisting of multiple chillers should be designed in such a way that the chilled water flow through a chiller should be automatically shut off when the chiller is shut down. For water-cooled chiller, the requirement is also applicable to condenser water pumping system. This is to avoid any water flow from entering the non-operated chiller which may result in elevation the plant’s water supply temperature.

As a good practice from ensuring the proper operation of the chiller isolation device, it is recommended to register false signal in BMS (or the chilled water plant controller) when any of the isolation device fails to activate or close fully. Such failure signal should alert the operation team to attend the necessary inspection, adjustment or rectification works.

6.9 Frictional Loss of Water Piping System (BEC clause 6.9)

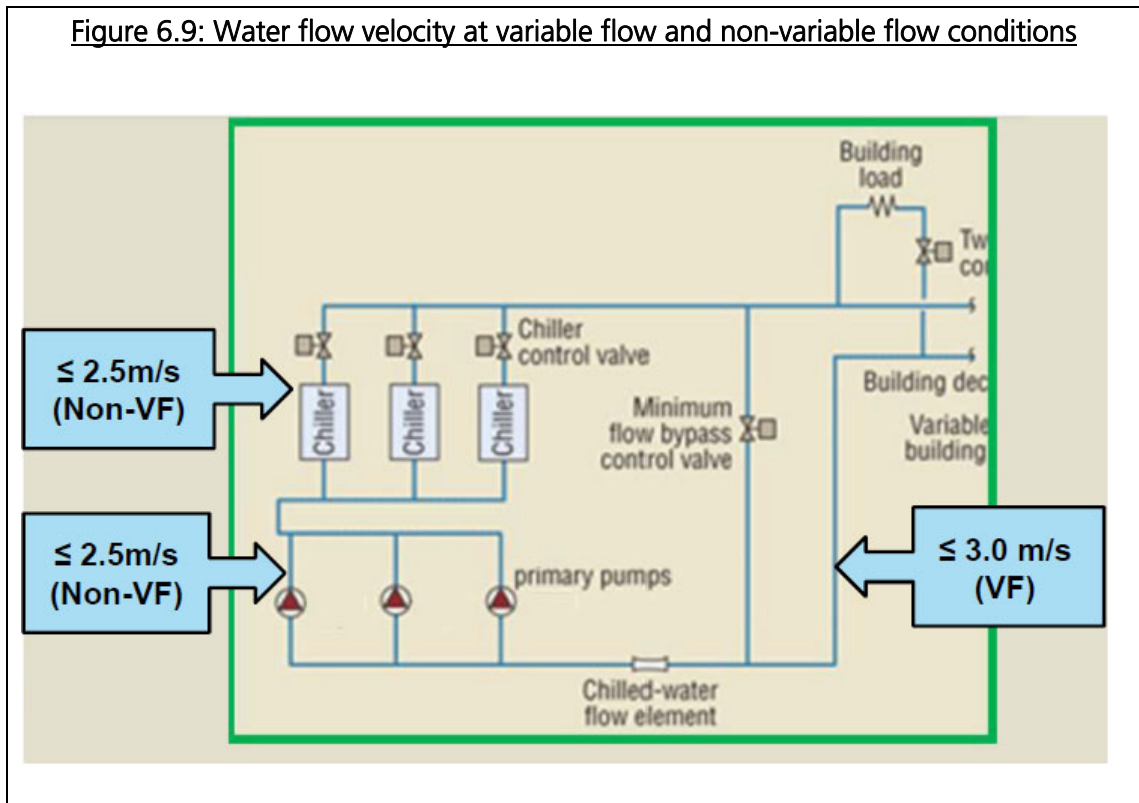
The requirement is illustrated using table form in TG Table 6.9 below. The designer should adopt a reasonably large pipe size in order to comply with the requirement targeted at reducing pump energy. The requirement is applicable to chilled water pipework, heated water pipework and condenser water pipework.

<b>Table 6.9 : Frictional Loss Requirement of Water Piping System</b>		
<u>Piping Diameter (mm)</u>	<u>Greater than 50mm</u>	<u>50mm</u>
Frictional loss (Pa/m)	≤ 400 Pa/m	Not applicable
Water flow velocity (m/s)	≤ 2.5 m/s (non-variable flow condition) ≤ 3.0 m/s (variable flow condition)	≤ 1.2 m/s

TG Figure 6.9 illustrates a typical differential bypass system with constant speed chilled water pumps. The building loop is regarded as variable flow condition under the BEC

clause 6.9 for the fact that the chilled water flow varies when the chillers are on and off in stage in respond to the loading demand and the piping system can be sized based on not exceeding 3.0 m/s water flow velocity.

The portion of pipework in between the chilled water return header upstream the chilled water pump and the chilled water supply header downstream the chillers is regarded as under non-variable flow condition and should be sized by using water flow velocity not exceeding 2.5 m/s.



## 6.10 System Control (BEC clause 6.10)

### 6.10.1 Temperature Control (BEC clause 6.10.1)

- (a) BEC clause 6.10.1 requires each air-conditioning system to be individually controlled by at least one automatic temperature control device in a space. The temperature control device such as thermostat should have provisions for controlling temperature setting to 29°C in case of cooling, and controlling temperature setting to 16°C in case of heating. A wider range of setting allows higher flexibility of operation and avoids unnecessary energy consumption due to over cooling or over heating.

The requirement on wider range of setting in respect of unitary air-conditioner is not meant for a control device –

- that forms an integral part of the air-conditioner, or
- that is offered by the air-conditioner's manufacturer as a standard ancillary to the

air-conditioner (and by ordering the air-conditioner the device would be available ex-factory in the same package of the air-conditioner).

- (b) Dead band setting is usually applied to a space provided with both heating and cooling. The dead band provision avoids unnecessary cooling or heating due to transient unsteady swing of space temperature around the thermostatic set point, by specifying a range of temperature that neither cooling nor heating would be called upon – the dead band. The BEC specifies the dead band to be at least 2°C, which would be adequate to absorb typical transience. An exemption from the 2°C dead band requirement is allowed for temperature control device that requires a manual change-over between cooling and heating modes.

#### 6.10.2 Humidity Control (BEC clause 6.10.2)

BEC clause 6.10.2 requires each air-conditioning system for removing or adding moisture to maintain specific humidity levels to be individually controlled by at least one automatic humidity control device. The humidity control device such as humidistat should have provisions for controlling humidity setting up to 60% in case of dehumidification, and controlling humidity setting down to 30% in case of humidification. A wider range of setting allows higher flexibility of operation and avoids unnecessary energy consumption due to over dehumidification or over humidification.

The requirement on wider range of setting in respect of a unitary equipment is not meant for a control device –

- that forms an integral part of the equipment, or
- that is offered by the equipment's manufacturer as a standard ancillary to the equipment (and by ordering the equipment the device would be available ex-factory in the same package of the equipment).

Humidity control is not common for the majority of applications in buildings in Hong Kong.

#### 6.10.3 Zone Control (BEC clause 6.10.3)

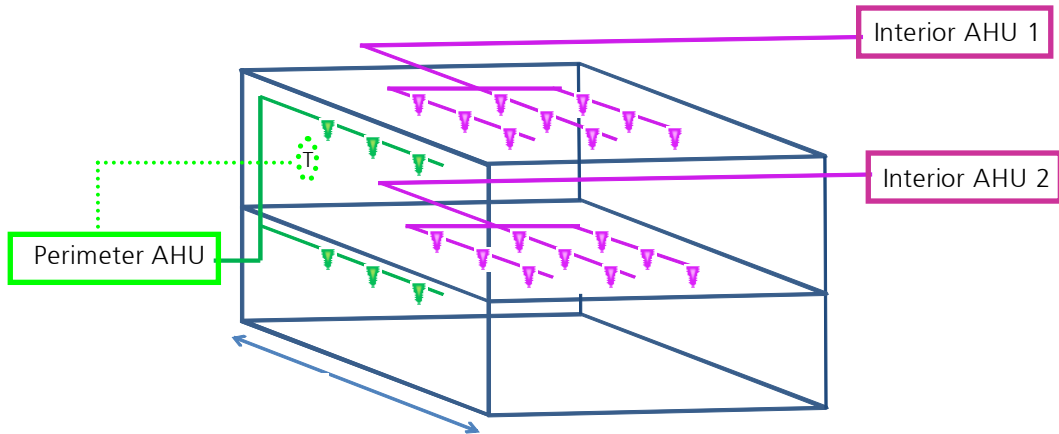
- (a) Individual Control and On Same Floor (BEC clauses 6.10.3.1 & 6.10.3.2)

BEC clause 6.10.3 requires each air-conditioning zone to be individually controlled by a temperature control device such as thermostat within a zone, and the spaces forming a zone should be on the same floor. An exemption from the same floor requirement is given, which is illustrated in TG Figure 6.10.3(a) below.

In TG Figure 6.10.3(a), the perimeter AHU serves the perimeter zone on both upper and lower floors, and is controlled by a thermostat within the zone, which can well reflect the zone temperature. There is a 15 m minimum contiguous length requirement for the concerned building exposure. Zones on facades with contiguous

length of less than 15m cannot span more than one floor.

**Figure 6.10.3 (a) : Allowable exemption from same floor requirement for a zone**



(b) Simultaneous Heating and Cooling (BEC clause 6.10.3.3)

Simultaneous heating and cooling, which refers to the heating of previously cooled air or the cooling of previously heated air, is in general not allowed in a zone for human comfort application, as specified in BEC clause 6.10.3.3. Conditional allowance are given, however, on grounds of enhanced control or when the impact on extra energy consumption is minimized, as shown in TG Table 6.10.3(a) below.

<b>Table 6.10.3 (a) : Allowance of Simultaneous Heating and Cooling</b>		
<u>BEC clause</u>	<u>Conditional Allowance</u>	<u>Justifications</u>
6.10.3.3 (a)	VAV supply air reduced to no greater than 30% of peak supply air flow	VAV itself is an energy saving feature and with the reduction to 30% of peak air flow the extra cooling/heating energy for purpose of maintaining enhanced room condition is much reduced
6.10.3.3 (b)	Pretreated fresh air AHU	To maintain desired room relative humidity not at the sacrifice of fresh air supply
6.10.3.3 (c)	75% of energy for reheating from recovered or renewable source	Extra reheating energy is much reduced with the use of recovered or renewable energy (site-recovered energy source such as from exhaust air, and renewable energy source such as photovoltaic panel)

6.10.3.3 (d)	Zone has a peak supply air flow of 140L/s or less	Small system, e.g. for around 10 m <sup>2</sup> floor space, has low impact on extra energy
6.10.3.3 (e)	Process requirements warranting specific humidity levels	Functional need for non-human comfort application

6.10.4 Off-hours Control (BEC clause 6.10.4)

(a) General Approach for Off-hour Control (BEC clauses 6.10.4.1 & 6.10.4.2)

For purpose of reduction of energy during off-hours, BEC clause 6.10.4 specifies that automatic controls should be provided for an air-conditioning system with cooling or heating capacity more than 10kW. Off-hours refer to time periods beyond normal occupancy hours and usually has a much lower energy demand.

There are two options of automatic off-hours control:

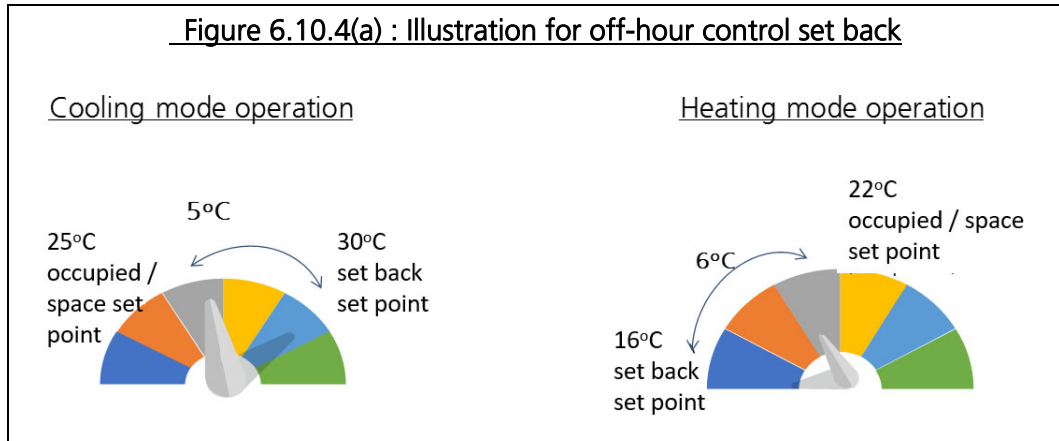
- (i) For control setback at the off-hours, air-conditioning system as required to maintain the space temperatures below an adjustable cooling set point at least 5°C above the occupied cooling set point during the cooling mode. Under the heating mode operation, air-conditioning system is required to maintain the space temperatures above an adjustable heating set point at least 6°C below the occupied heating set point. The concept is illustrated at Figure 6.10.4(a). The control setback aims at reducing energy wastage for provide air-conditioning to space under unoccupied conditions.

The air-conditioning system required less energy to maintain room temperature at the setback set point during unoccupied periods while the required period of time for resuming to the occupied set point at normal condition is shorter compare with total shutdown of the equipment.

- (ii) For equipment shutdown at the off-hours, automatic time scheduling system to control system on / off under different time schedules for 7-day per week should be required. Timer control with scheduling function and occupancy sensor are mentioned to facilitate the automatic control of shutdown for off-hours and resumption of service for normal hours. Manual override control for 2 hours to be provided for temporary operation of the system for 2 hours. Typical example of manual override control is push button for certain air-conditioning zone. Smart interface between mobile device/tablet and the control system may also be considered.

To enhance the effect, the automatic off-hours control can integrate with building’s overall building management system (BMS) with energy management function.

When the capacity is not more than 10kW, such as a system of split type air-conditioner or FCU, the adoption of manual off-hour control such as on/off switch is acceptable, provided that the control is readily accessible to the occupant or operator. With the controls in place, the air-conditioning system can be shut down or setback during the off-hours.



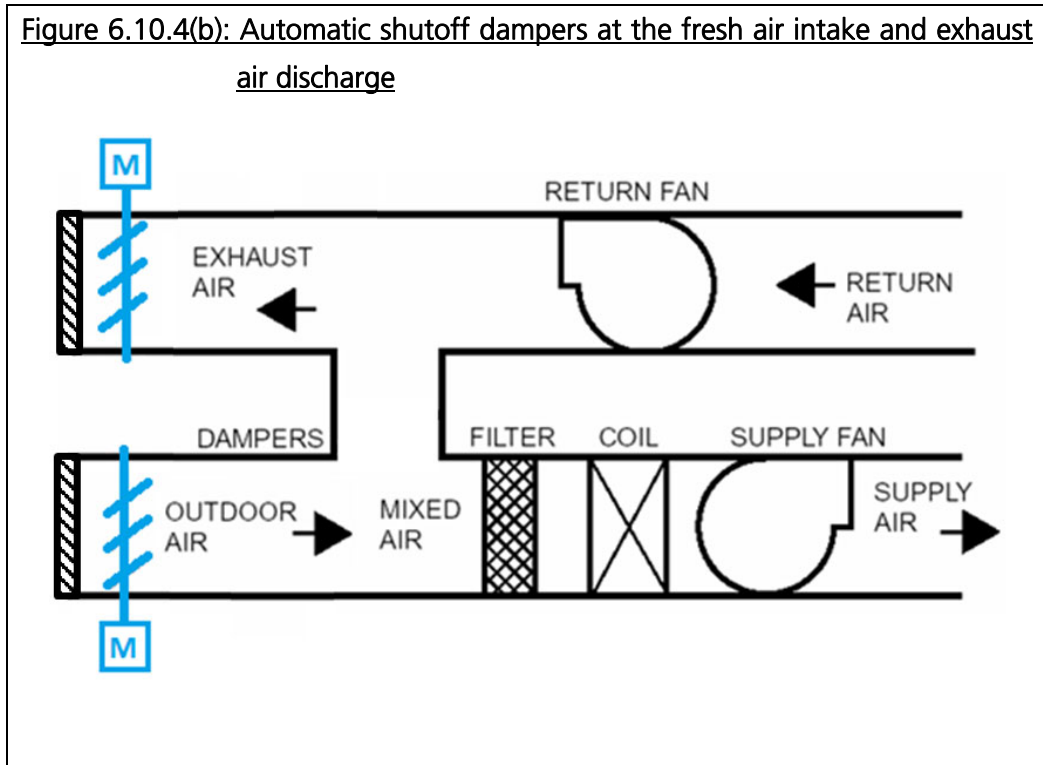
(b) Guest Rooms in Hotel, Guest House and Hostel (BEC clause 6.10.4.3)

For purpose of reduction of energy consumption when the guest room or suite is not occupied, BEC clause 6.10.4.3 requires the provision of a master control device in the guest room to turn off or setback the serving air-conditioning system. The setback may be by means of reduction of supply air, reduction of fan speed, or in case of cooling resetting of room temperature to at least 2°C higher than the set point and in case of heating resetting to at least 2°C lower than the set point. The card key device is a common type of master control device, which when inserted into a “switch slot” the air-conditioning can be turned on or resumed to normal setting, and vice versa if the card key is removed the air-conditioning can be setback or switched off.

(c) Automatic Shutoff Damper Controls (BEC clause 6.10.4.4)

BEC specifies automatic shutoff dampers to prevent moisture migration to the conditioned spaces through the air-conditioning systems when the systems are shutoff. In fulfilling the requirement, dampers should be provided at the fresh air intake and exhaust air discharge locations (i.e. the potential source of moisture ingress as demonstrated in TG Figure 6.10.4(b) of the air-conditioning systems and should operate automatically. Typical examples are electrically actuated motorized dampers or pneumatically actuated dampers. Deploying gravity damper does not fulfil the requirement since this kind of device may be forced open due to stack effect and wind pressure.





If the air-conditioning system is provided with pre-occupancy cool-down mode, the BEC requires keeping the dampers at the shutoff position when the system is set at such operation mode. This requirement stands also for the system if provided with off-hour setback mode.

The conditioned space in BEC clause 6.10.4.4 refer to a collective mean of spaces served by an air-conditioning system and, in the other words, the requirement on automatic shutoff damper is applicable to an air-conditioning system serving several conditioned space.

#### 6.10.5 Isolation of Zones (BEC clause 6.10.5)

##### (a) General Requirements

Air-conditioning system often serves zones that are occupied by different users/tenants and therefore may be occupied at different times. Energy wastage may occur when only a few zones served by the system are occupied leaving the unoccupied zones being conditioned. To avoid unnecessary energy wastage, the air-conditioning system serving zones intended to be occupied non-simultaneously should be divided into isolation areas.

An isolation area should not exceed 2,300m<sup>2</sup> of conditioned floor area nor include more than one floor. Each of the isolation area should consists of zones of similar characteristics in respect of space usage (e.g. office vs shop or front-of-house vs back-of-house), system layout, system configuration (e.g. all-air system vs fan coil units) or the nature of the space ownership (e.g. landlord vs tenant).

Each isolation area should be equipped with isolation devices and control capable of shutting off, automatically, the conditioned supply air and fresh air to and exhaust air from the area. The conditioned supply air refers also to the pre-treated fresh air from a primary air handling unit (PAU). Typical example of isolation device and control are the motorized damper being shut off through programmable DDC software or BMS (building management system) with a separate occupancy time schedule for each isolation areas.

For zone(s) intended to operate continuously or intended to be inoperative only when all other isolation areas are inoperative are not required to be equipped with isolation device (BEC clause 6.10.5.3 (c)). For example, entry lobby of a building may not be beneficial from isolation since it is occupied when any of the building areas are in operation.

The air-conditioning system and the chilled water plant (or the heated water plant) should be designed to allow stable system and equipment operation from any length of time while serving only the smallest isolation area served by the air conditioning system or the chilled water plant (BEC clause 6.10.5.2).

Fan with a VSD for static pressure control and axial fan with variable-pitch blades may also be able to operate at low flow. Where a fan cannot be selected to operate safely at low load, it can be replaced by multiple small fans in parallel with staged operation so only one fan operates at low load.

The same considerations should be applied to the chilled water plant. The plant should be able to operate at low loads for extended periods without involving frequent chiller cycling which is considered undesirable. Multiple chillers in staged operation should be considered. Variable-speed-driven chillers are also a viable option to deal with low load condition.

#### (b) Example Illustrating Isolation of Zones

Consider a shopping mall of three levels with retail units occupied by different tenants. As demonstration, the tenant areas on three levels are served by a centralized PAU (TG Figure 6.10.5 (a) refers).

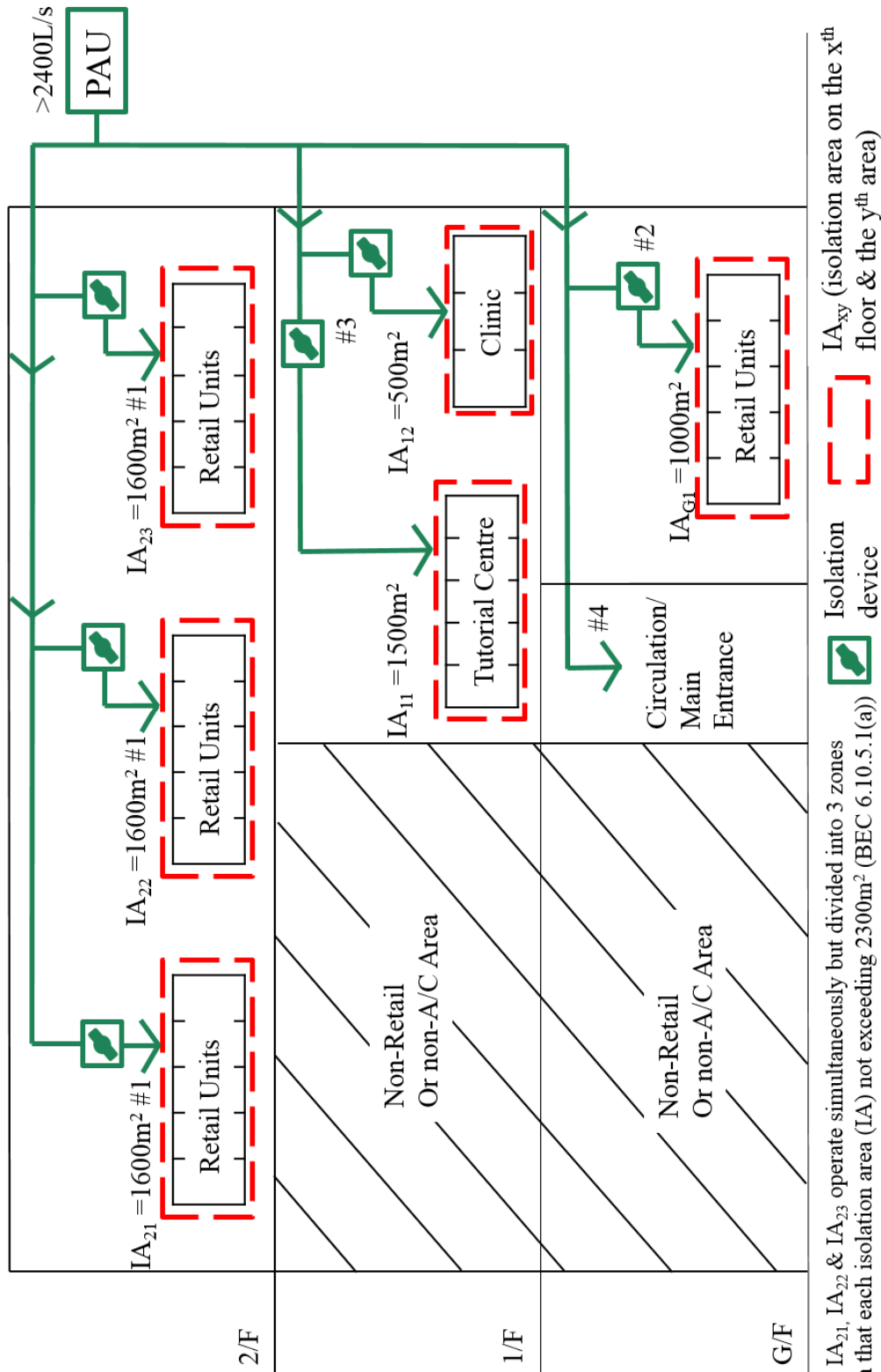
The retail units on 2/F are of similar operation schedule and are grouped into three isolation areas, i.e. the IA<sub>21</sub>, IA<sub>22</sub> and IA<sub>23</sub>, such that each of the isolation area does not exceed 2,300m<sup>2</sup>. The system is provided with an isolation device at the conditioned supply air (the pre-treated fresh air in this illustration) to each of the isolation area.

The conditioned floor area on 1/F counts up to 2,000m<sup>2</sup> only. Consider those tenancy units assigned as tutorial centres and those assigned as clinics are occupied

in different occupancy schedule. As such they are grouped into two isolation areas, i.e. the IA<sub>11</sub> and IA<sub>12</sub>.

Retail units on G/F are grouped under an isolation area IA<sub>G1</sub> since an isolation area should not include more than one floor. The main entrance and the associated circulation area are served by the air-conditioning system until of the rest of the retail units are closed. Isolation device is not required at the conditioned supply air serving this zone.

Figure 6.10.5 (a): Illustration of Isolation of zones



- (#1)  $IA_{21}$ ,  $IA_{22}$  &  $IA_{23}$  operate simultaneously but divided into 3 zones such that each isolation area (IA) not exceeding  $2300m^2$  (BEC 6.10.5.1(a))
- (#2) Isolation area are not to include more than one floor (BEC 6.10.5.1(a))
- (#3) Provide isolation when  $IA_{11}$  &  $IA_{12}$  are of different operation or occupancy schedule (BEC 6.10.5.1)
- (#4) No isolation device for the IA to be inoperative when all other IAs are inoperative

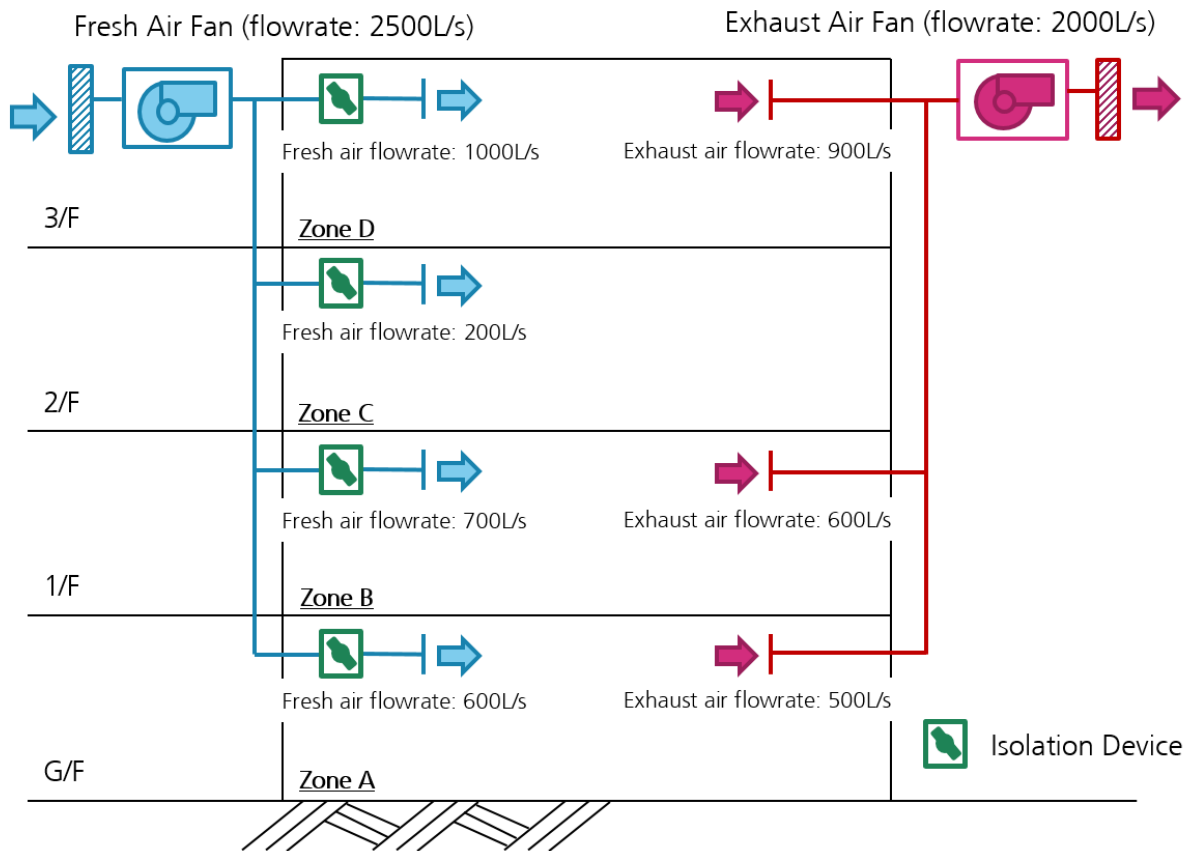
(c) Exception on Isolation Devices and Controls (BEC clauses 6.10.5.3 (a), (b) and (c))

According to BEC clause 6.10.5.3(a), isolation devices and controls are not required for exhaust air and fresh air connections to isolation areas when the fan system to which they connect is 2400 L/s or smaller. TG Table 6.10.5 and TG Figure 6.10.5 (b) illustrate the examples in this perspective.

BEC clause 6.10.5.3 (b) provides an exception applicable to a relatively small isolation area. Exception under BEC clause 6.10.5.3 (c) has been covered in the previous paragraphs.

Table 6.10.5 : Illustration of Requirement of Isolation of Zone				
Area	Fresh air		Exhaust air	
	Flowrate (L/s)	Isolation Device required?	Flowrate (L/s)	Isolation Device required?
Zone A	600	Yes	500	No
Zone B	700	Yes	600	No
Zone C	200	Yes	0	N/A
Zone D	1000	Yes	900	No
Total	2500		2000	

**Figure 6.10.5 (b): Illustration of Requirement of Isolation of Zones**



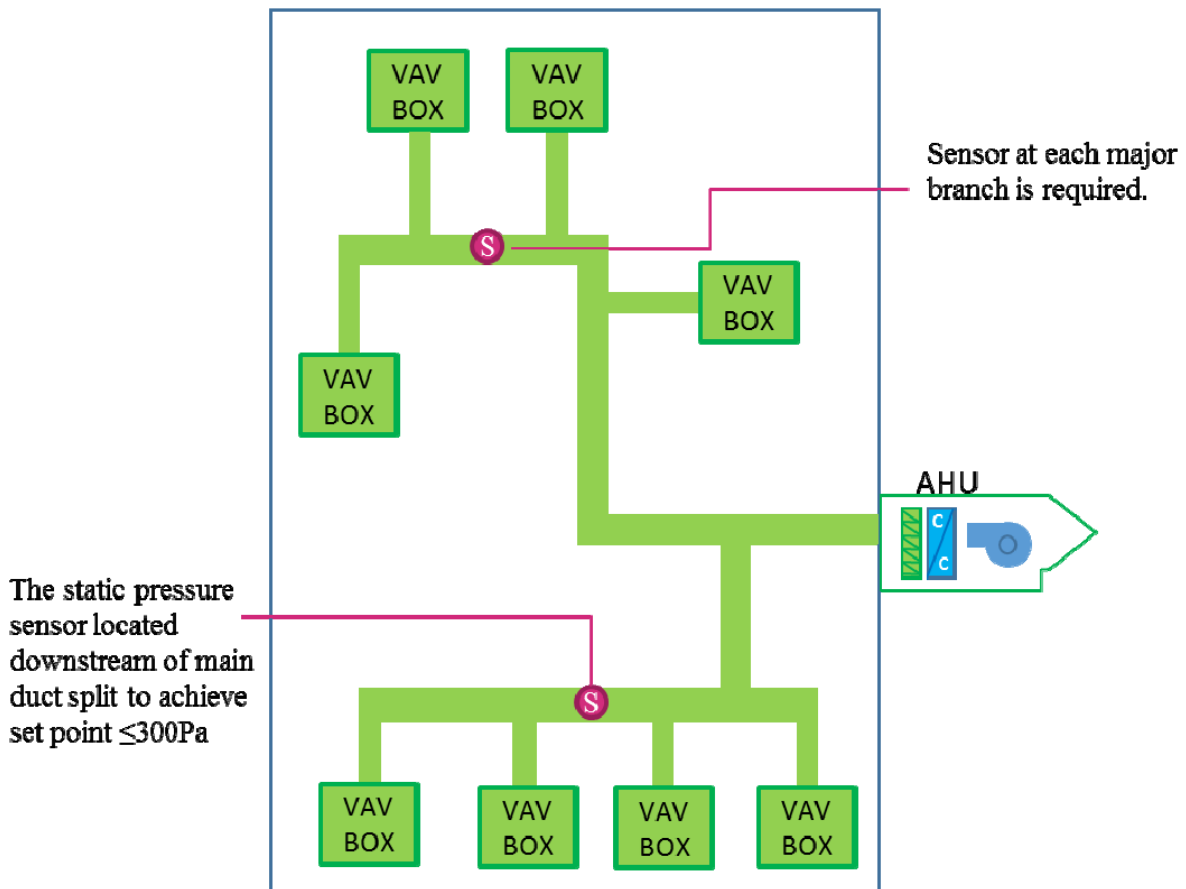
Attention should be paid that, although guest rooms in hotel are occupied non-simultaneously, the requirements on isolation area and the provision of isolation device and control are not applicable. The relevant energy efficiency requirements on guest rooms in hotel are governed under BEC clause 6.10.4.3.

#### 6.10.6 Control of VAV Air Distribution System (BEC clause 6.10.6)

The typical control principle of a VAV system is to maintain the static pressure inside the air duct by varying the supply air flow rate. The higher the static pressure set point, the higher the fan output pressure and hence the power consumption. BEC clause 6.10.6.1 specifies that the static pressure sensor should be located such that the controller set point should not be greater than 300 Pa. If this results in the sensor being located downstream of major duct split, sensors should be installed in each major branch to ensure the whole air distribution is properly controlled as illustrated in TG Figure 6.10.6.

As a good engineering practice, the designer may consider also to impose supply air temperature reset control logic to prevent the supply air fan operates at reduced efficiency at the very low speed for prolong period. Typically, the temperature reset logic step in when the fan speed drops down to the preset limit (say 30%).

**Figure 6.10.6: Example of static pressure sensor location**



BEC clause 6.10.6.2 specifies the provision of resetting the static pressure set point. Static pressure set point reset means rather than simply maintaining a specified supply air duct static pressure and assuming the zones downstream are satisfied, the control can monitor the zones and adjust the static pressure set point according to actual demand. This allows the use of the lowest required static pressure set point to maximize the potential energy saving.

The exact design control logic should be under the discretion of the designer in accordance with the configuration of the air-conditioning system and the space loading profile.

A typical arrangement may involve having the set point be reset down until one zone VAV box approaches wide open. The static pressure set point may be reset up if a zone cannot maintain the temperature set point at wide open.

### 6.10.7 Demand Control Ventilation (DCV) (BEC clause 6.10.7)

#### (a) DCV in Carpark (BEC clause 6.10.7.1 and 6.10.7.2)

BEC clause 6.10.7.1 specifies that a carpark ventilation system should be designed to operate with staging or modulation of fans, based on the detected contaminant level, to provide down to 50% or less of the design capacity. Staging may be achieved by on and off multiple single-speed fans connected in parallel or deploying two-speed fans.

**Figure 6.10.7 (a): Example of CO/NO Sensor**



BEC clause 6.10.7.1 further specifies that the ventilation system serving basement carpark could also consider to respond to the space temperature so as to avoid the occurrence of localized hot spot.

The requirement on fan staging or modulation is applicable to exhaust air fans and the fresh air fans. Jet fans, if deployed, are not required to be operated in stage on and off or modulation in order not to reduce the effectiveness of conveying the contaminant.

For ventilation system with the total fan motors' nameplate power, including the fresh air fans, exhaust air fans and jet fans, of less than 11kW, the requirement on DCV is not applicable.

#### (b) DCV in air-conditioned space (BEC clause 6.10.7.3 and 6.10.7.4)

BEC clause 6.10.7.3 specifies that an air-conditioning system serving a conditioned space with design fresh airflow rate of 1400 L/s or above should be provided with DCV (as illustrated in TG Figure 6.10.7(b) ) in such a way that the outdoor air supplied to the space is modulated as a function of the number of occupants



present.

The conditioned space with high level of occupancy may typically include assembly spaces such as function rooms, ball rooms, theatres and exhibition halls etc. Exception from the DCV requirement is given for a system provided with exhaust air energy recovery. The equipment/component in relation to exhaust air energy recovery includes plate heat exchangers, heat pipes, run-around coils, and enthalpy wheels.

The requirement on DCV is applicable to both AHU and PAU. The fresh air dampers connecting to the AHU or the PAU should be designed to modulate in accordance with the CO<sub>2</sub> level of the conditioned space served by the air-conditioning system unless the system is operated at the free cooling mode if provided.

Attention is drawn to the fact that the requirement is not applicable to an air conditioning system serving more than one conditioned spaces. For example, DCV is not required for an AHU serving 2 separated offices as shown in TG Figure 6.10.7(c).

In case of the multiple function rooms or ballrooms of a hotel, for example, being occupied separately by moveable partitions, the requirement on DCV may become applicable when the rooms are combined into a single conditioned space with the total fresh airflow rate of or above 1400 L/s. Such compliance demonstration is illustrated and elaborated in TG Figure 6.10.7 (d).

Figure 6.10.7 (b) : Illustration of DCV requirement (1)

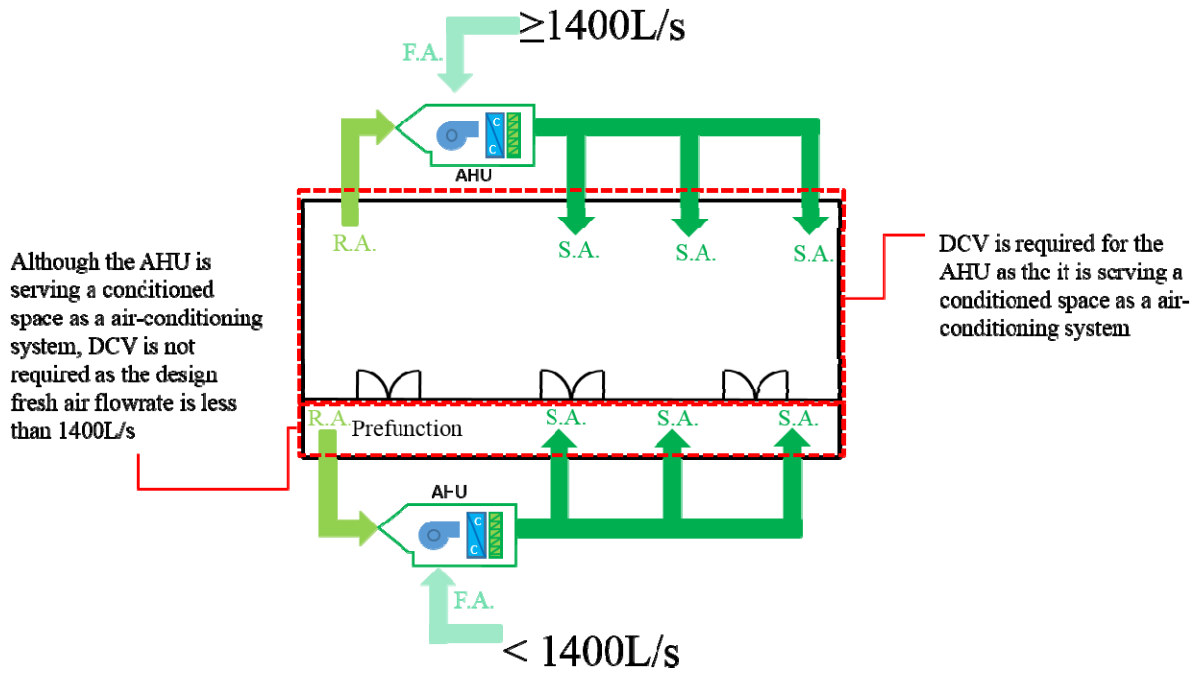


Figure 6.10.7 (c) : Illustration of DCV requirement (2)

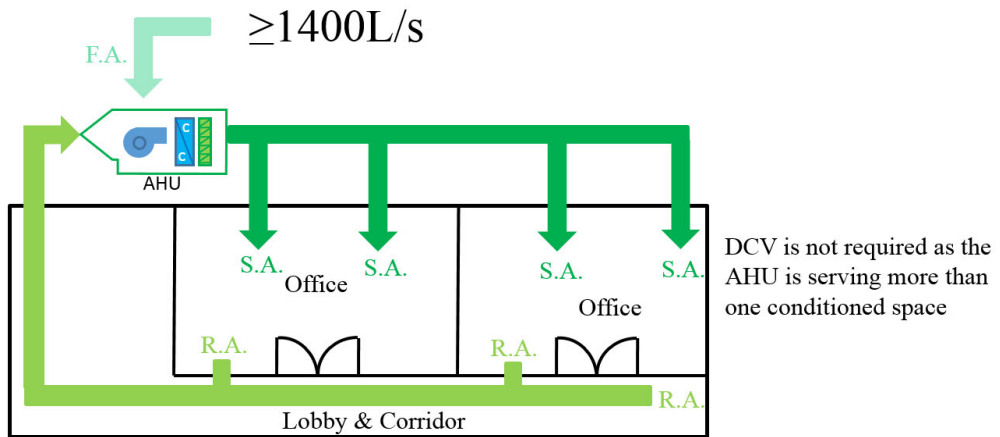
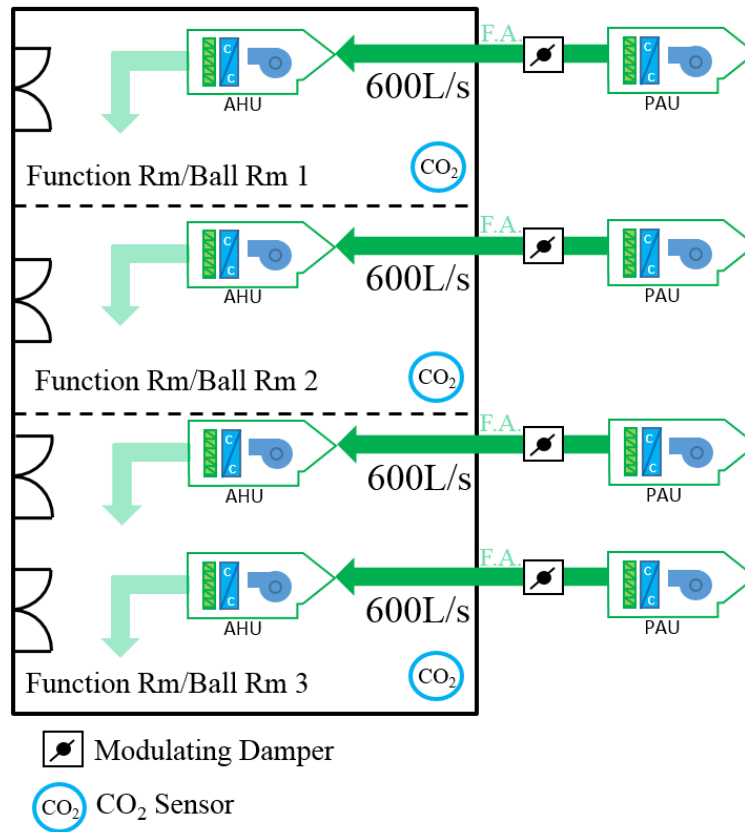


Figure 6.10.7 (d) : Illustration of DCV requirement (3)



	Case 1	Case 2	Case 3	Case 4	Case 5	Case 6	Case 7
Function Rm/Ball Rm 1	✓	✗	✗	✓	✓	✗	✓
Function Rm/Ball Rm 2	✗	✓	✗	✗	✓	✓	✓
Function Rm/Ball Rm 3	✗	✗	✓	✓	✗	✓	✓
DCV Required?	No	No	No	No	No	Yes	Yes
✓ Space occupied ✗ Space not in use	Fresh air rate in each case in each conditioned space < 1400L/s					Yes	Yes
	Function Rm/Ball Rm 2 & 3 occupied simultaneously as one conditioned space						
	Ditto for Function Rm/Ball Rm 1, 2 & 3						

6.11 Thermal Insulation (BEC clause 6.11)

6.11.1 Tabulated Insulation Thickness (BEC clause 6.11.1)

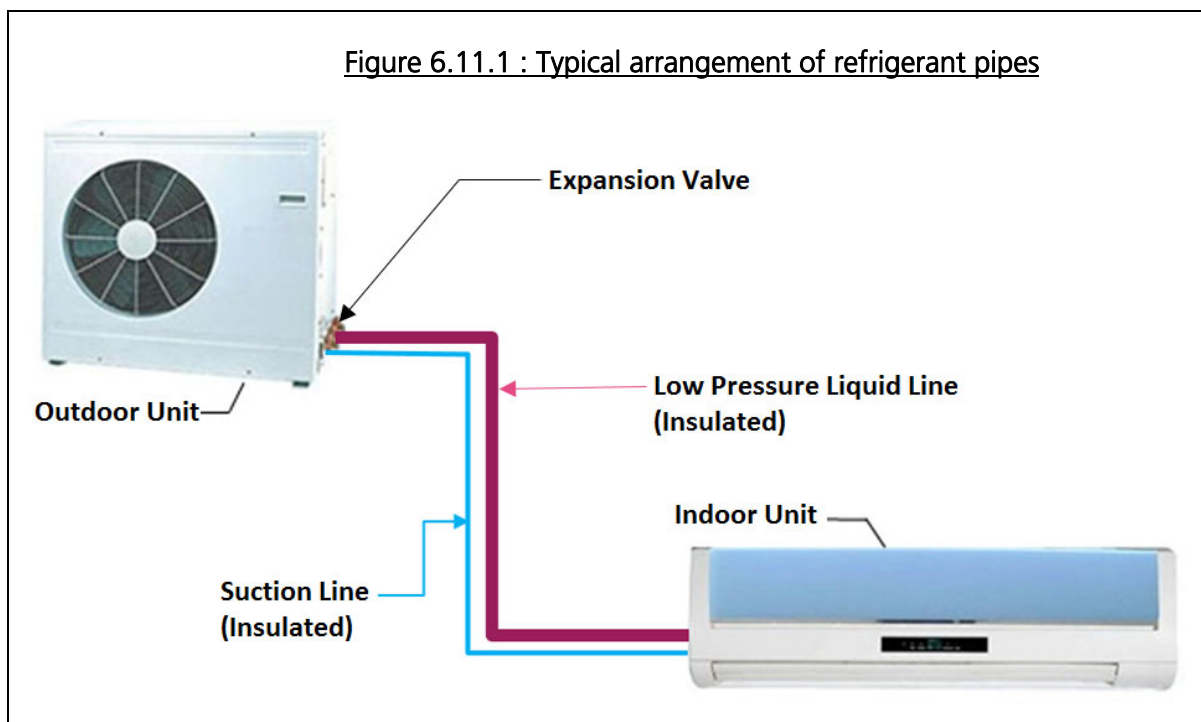
(a) General Requirements

- i) BEC clause 6.11.1 requires the minimum thickness of insulation to be applied to cold surfaces of pipework, ductwork and AHU to be in accordance with the tabulated values in BEC Tables 6.11a, 6.11b and 6.11c respectively, which specify the thickness with regard to the thermal conductivity of the insulating material, the surface coefficient of the insulation's external surface, the line temperature of the fluid carried, and the surrounding ambient conditions.
- ii) BEC Tables 6.11a, 6.11b and 6.11c are meant for insulation to site-installed pipework and ductwork and site assembled AHU/FCU casing, and not for manufacturer-applied insulation to pipework/ductwork/casing integral to chiller, unitary air-conditioner, AHU or FCU ex-factory.
- iii) Given insulation products usually come in cylindrical sections, tubes or sheets of standard thickness, which may not fully match all the tabulated thickness figures in BEC Tables 6.11a, 6.11b and 6.11c. As such, it would be common that the applied insulation has to be slightly thicker than the tabulated value.
- iv) The equations calculating the thickness are given in items (b) & (c) below, which are common heat transfer equations. For purpose of simplification, BEC clause 6.11.1 specifies as requirement the tabulated values and not the equations. The tabulation provides the convenience of knowing the required thickness without going through the reiterative calculations in item (b) below. Values of thermal conductivity and surface coefficient of the insulating materials could normally be found in product catalogues or supplier's technical brochures of these materials.

There are insulation materials with thermal conductivity  $\lambda$  or surface coefficient  $h$  different from those in the tables, and likewise there may be different line temperatures  $\theta_l$ . Under the circumstances the equations in item (b) may be used to calculate the thickness; attention is drawn to the remark in item (d) below on ambient conditions to be adopted.

- v) BEC Table 6.11c specifies the insulation thickness (for ductwork and AHU casing) for a temperature difference (between the air inside duct/casing and its surrounding) of 20°C and of 15°C. Calculations for 10°C temperature difference (typically for return air duct) is given in TG Table 6.11.1 (a) below, which may be deemed as a supplement to BEC Table 6.11c for thickness values at the temperature difference of 10°C.

- vi) The calculated thickness decreases with decreasing temperature difference. A minimum thickness of 13 mm is suggested for calculated thickness below this value.
- vii) The requirement is applicable to suction refrigerant pipe but not the discharge refrigerant which carries hot refrigerant gas. The suction refrigerant pipe carries cold refrigerant gas is usually in lower pressure. This refers the portion of refrigerant pipe between downstream the expansion valve and upstream the compressor.



- viii) BEC Table 6.11c governs, as per the introductory paragraph in BEC clause 6.11.1, ductwork carrying cooled air. BEC Table 6.11c thus does not govern ductwork carrying heated air. Ductwork not carrying cooled air but carrying fresh air are not governed, as such are less energy related, and likewise ductwork carrying exhaust air are not governed; nevertheless these ductwork may still have to be insulated to avoid condensation.

<b>Table 6.11.1 (a) : Minimum Insulation Thickness for Ductwork and AHU Casing<sup>@1</sup></b>										
Ambient Condition	Outdoor <sup>@2</sup>				Unconditioned Space <sup>@2</sup>				Conditioned Space <sup>@2</sup>	
Thermal conductivity $\lambda$ (W/m-°C) <sup>@3</sup>	0.024		0.04		0.024		0.04		0.024	0.04
Surface coefficient h (W/m <sup>2</sup> -°C) <sup>@4</sup>	9	13.5	9	13.5	5.7	10	5.7	10	any value	
Temperature difference between air inside duct/casing and surrounding of duct/casing	Insulation thickness (mm) <sup>@1</sup>									
10 °C	13	13	21	14	20	13	33	19	13	18
<b>Remarks<sup>@1 to @4</sup></b> This table may be regarded as a supplement to BEC Table 6.11c and the same remarks therein apply to both tables.										

(b) Heat Transfer Equations for Pipework

The following approach using heat transfer Equations (a) and (b) has been used in arriving at the tabulated values in BEC Tables 6.11a and 6.11b. Equation (b) specifically accounts for the heat transfer over a circular surface.

- i) Calculate using equation (a) the provisional thickness  $\chi$  (unit – mm) based on known values of the variables in Equation (a).

$$\chi = 10^3 \times \lambda/h \times \{(\theta_d - \theta_1)/(\theta_m - \theta_d)\} \dots\dots\dots \text{Equation (a)}$$

Where h = Surface coefficient of external surface of insulation - W/m<sup>2</sup>-°C

$\lambda$  = Thermal conductivity of insulating material - W/m-°C

$\theta_d$  = Dew point temperature - °C

$\theta_1$  = Temperature of the cold surface (line temperature) - °C

$\theta_m$  = Temperature of the ambient still air - °C

- ii) Roughly estimate the value of  $L_a$  based on general engineering practice, and calculate using Equation (b) the provisional thickness  $\chi$  (unit – mm) based on known values of the variables in Equation (b).

$$\chi = 0.5 (d_o + 2L_a) \times \ln [1 + 2L_a/d_o] \dots\dots\dots \text{Equation (b)}$$

Where  $L_a$  = Estimated minimum thickness – mm, which will converge to become the actual value through iterations

$d_o$  = Outside diameter of pipe or tube – mm

- iii) Compare the two calculated values of thickness in items (i) and (ii). The estimated  $L_a$  value will be deemed to be the actual thickness if the two  $\chi$  values

are reasonably close to each other. Should the two values not be reasonably close, conduct an iteration of Equation (b) with another estimated likely converging value of  $L_a$ .

(c) Heat Transfer Equation for Ductwork

Equation (a) above has been used in arriving at the tabulated values in BEC Table 6.11c. The use of Equation (b) is not required, as no circular surface is involved. Simply calculate using Equation (a) the thickness  $\chi$  (unit – mm) based on known values of the variables in Equation (a).

(d) Ambient Conditions

The respective surrounding temperature and humidity are fixed for each of the ambient conditions of “outdoor”, “unconditioned space” and “conditioned space”. The adherence to a fixed temperature and humidity for an ambient condition serves to provide the uniformity in the determination of insulation thickness for that ambient condition.

A false ceiling void is normally regarded as an unconditioned space, unless it also serves as a return air plenum or its segregation is on perforated panels, slot ceilings or slats.

If the false ceiling void is above the functional area with AC provision, a written declaration of the environmental condition should be provided by REA together with calculations and measurements as supporting documents for the proposed environmental condition.

6.11.2 Insulation for Outdoor or Unconditioned Space (BEC clause 6.11.2)

In order to prevent degradation of insulation due to moisture ingress, over time in particular, which is common for outdoor and unconditioned space applications, BEC clause 6.11.2 requires the insulation to be of water vapour retardant type, examples being the closed cell type insulation, fiberglass insulation with multi-layer double-side reinforced aluminium foil (to achieve water vapour permeance) and sealed at joints using aluminium foil adhesive tape, insulation coated with heavy duty mastic over reinforcing membrane etc. For insulation in plant rooms or areas with likely frequent visits by O&M personnel, it is a good engineering practice to further protect the insulation with metal cladding or cement plaster.

6.12 Air-conditioning Equipment Efficiency (BEC clause 6.12)

6.12.1 Minimum Allowable Efficiency at Standard Rating Condition

BEC Tables 6.12a and 6.12b specify the minimum full load coefficient of performance (COP) of an equipment at the corresponding standard rating condition. The COP is

irrespective of the type of refrigerant e.g. R407c, R134a, R410a etc. used in the vapour compression cycle of the equipment. A standard rating condition is a reference condition of the COP, whereas the operation conditions are left to the discretion of the building operator. The standard rating conditions in the BEC are specific to Hong Kong weather and applications. The COP at the standard rating condition may be found in the equipment catalogue of suppliers or manufacturers, and should the data not be shown the supplier or manufacturer should be consulted for provision of more detailed technical brochure that contain the data. Attention is drawn to the remarks in the tables, in respect of the determination of COP for equipment with high static fans based on normal fans for free air flow.

### 6.12.2 Unitary Air-conditioner and Variable Refrigerant Flow (VRF) System

#### (a) Room air-conditioner (BEC clause 6.12.2)

For a room type unitary air-conditioner or room air-conditioner, under the scope of the Mandatory Energy Efficiency Labelling Scheme under Energy Efficiency (Labelling of Products) Ordinance (Cap. 598), BEC clause 6.12.2 requires the equipment to fulfill Energy Efficiency Grade 1 or Grade 2 requirement as stipulated in the Code of Practice on Energy Labelling of Products 2020.

Room air-conditioners under the Labelling Scheme include the single package window type and wall mounted split type, but not the ceiling mounted type, floor standing type, fan coil unit type, and types with ductwork for supply or exhaust air. The significance of Energy Efficiency Grade 1 and Grade 2 are given in TG Table 6.12.2 (a) below as extracted from Table 7.8 & 7.9 of the Code of Practice on Energy Labelling of Products 2020.

<u>Table 6.12.2 (a) : Performance of Energy Efficiency Grade 1 and Grade 2 Equipment under the Code of Practice on Energy Labelling of Products 2020 (<i>the Code</i>)</u>		
<u>Energy Efficiency Grade</u>	<u>Cooling</u>	<u>Heating</u>
1	$4.50 \leq F_{CSP}$	$3.60 \leq F_{HSP}$
2	$3.50 \leq F_{CSP} < 4.50$	$3.10 \leq F_{HSP} < 3.60$
Remarks		
$F_{CSP}$ – Cooling seasonal performance factor as defined under clause 7.6.1 of <i>the Code</i>		
$F_{HSP}$ – Heating seasonal performance factor as defined under clause 7.6.1 of <i>the Code</i>		



For the window type room air conditioners obtain Grade 1 & Grade 2 under the new grading standard in the 2020 edition of the Code, it required a much higher cooling seasonal performance factor and heating seasonal performance as listed below:

**Table 6.12.2 (b) : New Grading Standard for Window Type Room Air Conditioners under the Code of Practice on Energy Labelling of Products 2020**

**製冷季節性表現系數 (CSPF)  
Cooling Seasonal Performance Factor (CSPF)**

能源效益級別 Energy Efficiency Grade	製冷季節性表現系數 Cooling Seasonal Performance Factor (CSPF)	
	舊評級標準 Old Grading Standard	新評級標準 New Grading Standard
第1級 Grade 1	≥3	≥4.5
第2級 Grade 2	≥2.8	≥3.5

**供暖季節性表現系數 (HSPF)  
Heating Seasonal Performance Factor (HSPF)**

能源效益級別 Energy Efficiency Grade	供暖季節性表現系數 Heating Seasonal Performance Factor (HSPF)	
	舊評級標準 Old Grading Standard	新評級標準 New Grading Standard
第1級 Grade 1	≥2.6	≥3.6
第2級 Grade 2	≥2.4	≥3.1

(b) Other Unitary Air-conditioner

The minimum full load COP for unitary air-conditioners of types other than the room air-conditioner type are specified in BEC Table 6.12a (Part 1), which includes the single packaged type, ceiling mounted split type, floor standing type, fan coil unit type, ductwork connected type, units deploying change of refrigerant volume flow to cope with loading demand, multi-split type and heat pump type.

(c) VRF System (BEC Table 6.12a (Part 2))

TG Table 6.12.2 (b) below describes at the right column a VRF system in terms of capacity range and physical configuration. The VRF system is a mid-to-large scale system offering over 200kW cooling capacity at the high end. The compressor

unit running in variable speed may connect over 60 indoor units each equipped with its own expansion valve (EV) allowing individual control in response to the conditioned space demand. BEC Table 6.12a (Part 2) mandates the energy efficiency performance of such VRF system at full load condition while the standard configuration are shown on remarks item 3 of the Table.

The left hand column shows a typical multi-split system, as previously mentioned in paragraph (b) above, with rated capacity up to 10 kW, consisting of a single outdoor unit running at constant speed or variable speed serving up to four indoor units. The outdoor unit houses all the EVs and therefore connects to each of the indoor units through individual refrigerant pipe.

**Table 6.12.2 (c): Typical VRF System and other multi-split units/ system**

Typical multi-split	Hybrid multi-split	Typical VRF System
CS or VS	VS typically	VS
4 to around 10 kW	8 to around 20 kW	From 25 kW to over 200 kW
≤ 4 indoor units	Up to 8 or 9 indoor units	Over 60 indoor units
All EVs at outdoor unit	Up to 3 EVs inside a distribution box each connecting 2 to 3 indoor units	EV located inside each indoor unit
May have only simple control	Typically with computerized zone control	Computerized zone control

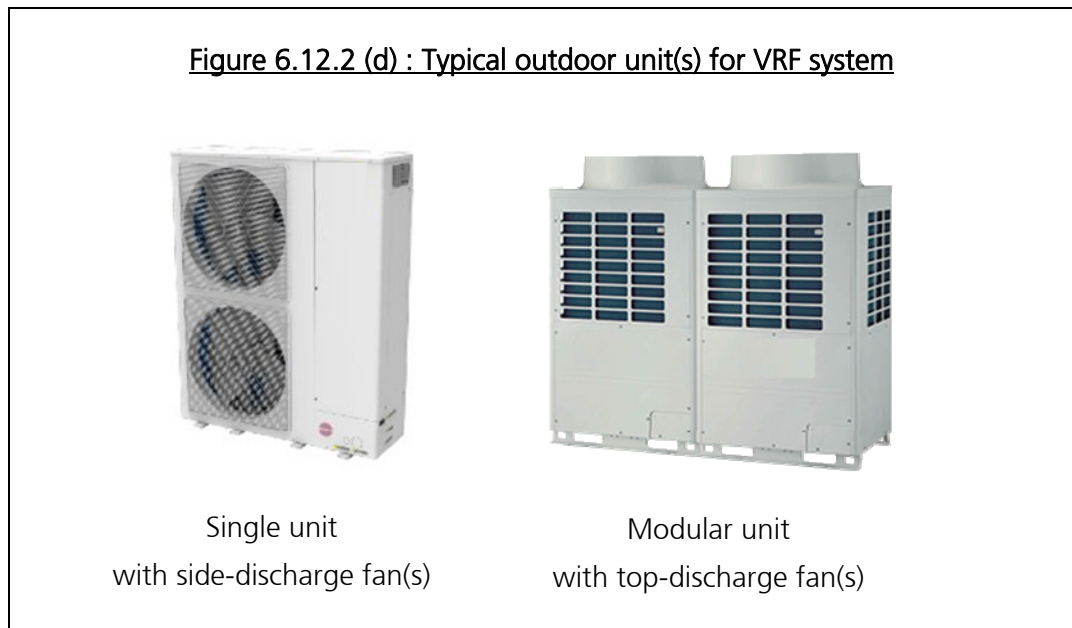
*Remarks:*

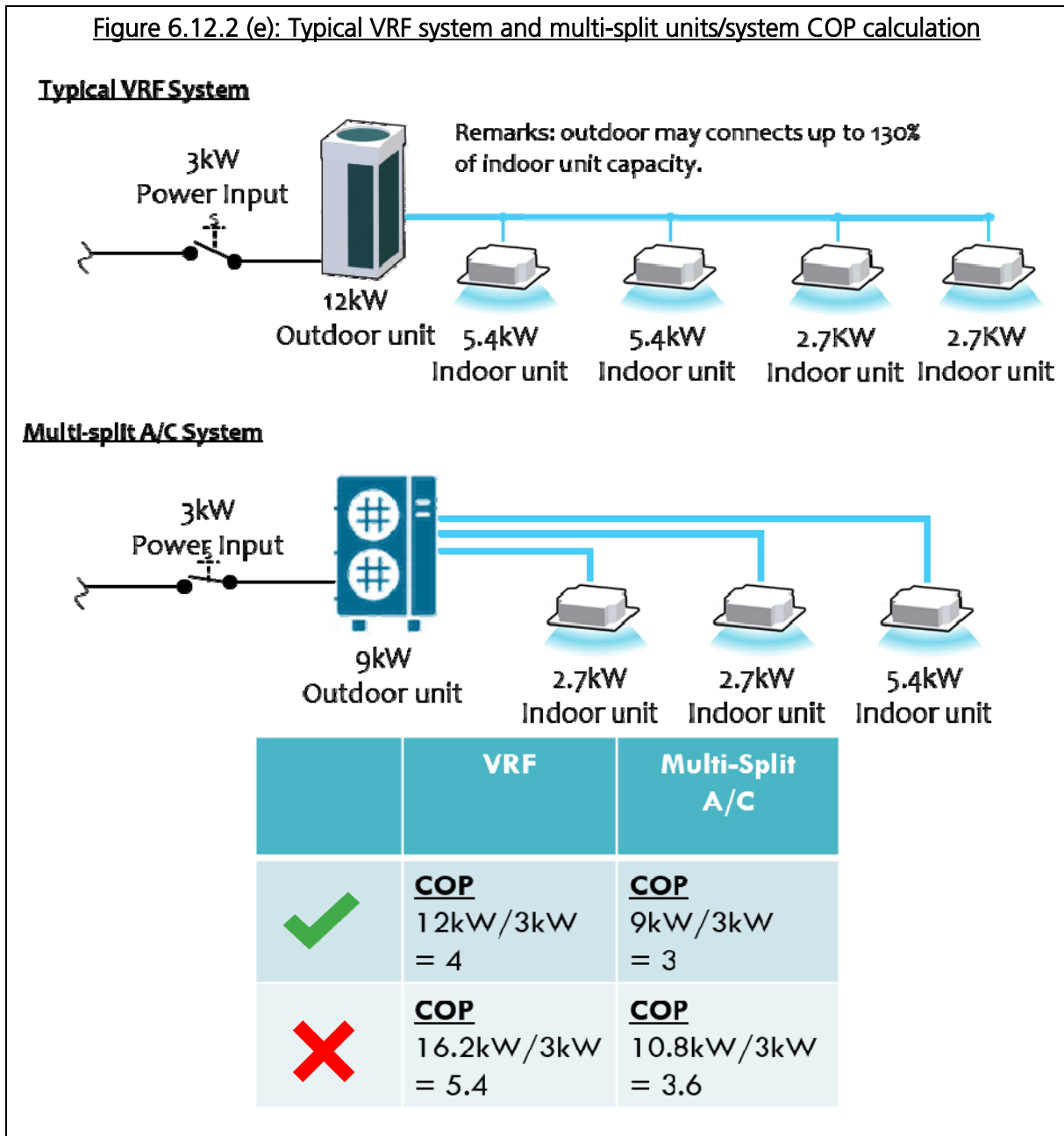
*The figures or the capacity ranges come from a general capture of a few brands in the market and therefore these do not necessarily represent the ultimate limits and ranges. These figures or capacity ranges should be not used to define a system but serve for the sole purpose of facilitating discussion and the ease of understanding. Care must be taken when referencing to these figures or capacity ranges given the fact that these are subject to change due to technology advancement and market trend and vary among the vendors.*

In between the extremities, there exists, as shown on the middle column, a hybrid multi-split system offering rated capacity up to 20 kW serving 8 or 9 indoor units. The system typically consists of several distribution boxes each housing 2 to 3 EVs serving the indoor units downstream. Some suppliers may name it as “mini-VRF” or “high performance multi-split”.

Under the BEC, the “hybrid multi-split” and the “typical multi-split” as illustrated in TG Table 6.12.2 (b) are regarded as “Unitary Air-Conditioner” and should comply with the energy efficiency requirements as prescribed in BEC Table 6.12a (Part 1).

In addition, BEC Table 6.12a (Part 2) mandates the energy efficiency performance of VRF system at full load condition with the consideration of modular unit with top-discharge outdoor units and single unit with side-discharge outdoor units. The difference of the discharge method impacts on the capacity of the VRF system. Hence, the capacity and energy efficiency requirement are separately considered at these two different discharge methods in the latest BEC edition.





(d) Determination of COP (BEC Table 6.12a)

Figure 6.12.2 illustrates the COP calculation methodology for typical VRF system and multi-split A/C system with outdoor unit of 12kW and 9kW respectively and power input on both cases of 3kW. The figure clarifies that the COP calculation should be addressed as cooling output divided by the power input to outdoor unit. Since certain spare cooling capacity will usually be reserved for indoor units, the COP calculation based on the total cooling capacity of the indoor units is incorrect.

### 6.12.3 Chiller and Heat Pump (BEC Table 6.12b & Table 6.12c)

#### The Less Common Chiller

BEC Table 6.12b specifies the COP for the common types of chillers in Hong Kong. The table has not included the less common chiller types such as absorption chiller, heat recovery chiller, ice making chiller, evaporatively-cooled chiller etc. The heat recovery chiller consists of a separated bundle alongside the condenser. The bundle delivers heat output, which is likely of non-guaranty amount in form of "by-product", when it is set at the heat recovery mode. The evaporatively-cooled chiller refers to a chiller with an evaporatively-cooled condenser that condenses the refrigerant in the condenser tubes by mechanically circulating over the exterior tube surfaces with a mixture of air and water.

#### High Temperature Chiller

The industry is experiencing a rising trend of applying high temperature chiller (HTCh) for systems involving chilled beam and equipment rack cooling etc. The design performance of the HTCh at the elevated chilled water supply temperature (typically set at 15 °C) is required to be recorded and submitted for reference. The chiller's projected COP figure under the standard rating conditions as set out in BEC Table 6.12b (i.e. when the chilled water temperature set at 7 °C out and 12.5 °C in) should also be provided as an indication on its energy efficiency performance only. The report or statement record from the HTCh supplier should be provided as the substantiation on the projected COP figure.

#### VSD Chiller Part-load Performance

A VSD chiller once being specified should be expected of a higher chance to operate under part load condition. As such, a VSD chiller has to comply with the energy efficiency requirements both at the full load and the 75%-load conditions to BEC Table 6.12b. The rating conditions at the 75%-load is shown on the remarks column of BEC Table 6.12b and repeated in table form as illustrated in TG Table 6.12.3 below.

A chiller commonly known as oil free chiller or chiller with magnetic bearing is regarded as VSD chiller under the BEC.

<b>Table 6.12.3 Standard Rating Conditions for VSD Chiller at 75% of the Full Load</b>							
<u>Type of Cooling</u>	<u>Air-cooled</u>			<u>Water-cooled</u>			
Operation condition	Condenser ambient temperature	Chilled water temperature		Condenser water temperature		Chilled water temperature	
		In	Out	In	Out	In	Out
		27°C	12.5°C	7°C	24°C	29°C	12.5°C

Heat Pump

Heat pumps of a heated water plant serving an air-conditioning installation are governed under the BEC Table 6.12c. The energy efficiency requirements on air-to-water and water-to-water heat pump in term of COP are being formulated in this table.

6.12.4 Requirement for Open-circuit Cooling Tower (BEC clause 6.12.4)

BEC mandates the energy efficiency performance of cooling tower fan by relating the fan power with the design condenser water flow. A higher value of water flow per unit tower fan motor nameplate power implies better energy performance.

In general, designers should use axial or propeller fan cooling towers when possible. Centrifugal fan cooling towers might likely be required when the fan is subjected to additional external static pressure in particular at acoustically sensitive locations. As an alternative to centrifugal fans in these applications, the designer may consider cooling towers with lower-sound axial or propeller fans.

6.12.5 Cooling tower fan part load performance (BEC clause 6.12.5)

BEC clause 6.12.5 requires the fan(s) of an open-circuit cooling tower served by an individual motor or an array of motors with the rated motor power totaling 3.7 kW or above should incorporate control and devices that should result in the fan motor demand no more than 30% of design input power at 50% of design air flow. It is common by using the variable-speed drive to control the fan speed. Other methods, such as two speeds motor, is also acceptable if the power reduction can be achieved. Automatic control to be provided to control the leaving condenser water temperature of the cooling tower by adjusting the cooling tower fan speed and to maintain the required condensing water temperature.

6.13 Energy Metering (BEC clause 6.13)

- (a) BEC clause 6.13 requires the provision of continuous monitoring devices for energy metering. A summary in table form is given in TG Table 6.13(a) below. When each of the chillers of a chilled water plant is equipped with energy metering as prescribed under BEC clause 6.13.1, the chilled water plant should still be equipped with energy metering in accordance with BEC clause 6.13.2 in order to facilitate the measurement of the plant's COP. In determination of the chilled water plant COP, the standby provision (e.g. the chiller of N+1 configuration) and ancillary equipment (e.g. water treatment system) could be excluded.

<b>Table 6.13 (a) : Energy Metering for Air-conditioning Equipment and Chilled/Heated Water Plant</b>		
<u>Equipment / Plant</u>	<u>Capacity</u>	<u>Parameters to be measured</u>
Chiller, heat pump or unitary air-conditioner	≥ 350kW (cooling /heating)	<u>Input, electrical</u> power (kW); energy (kWh)
Chilled/heated water plant		<u>Output, cooling/heating</u> water temperature (°C), flow rate (l/s), power (kW); energy (kWh), COP
Air Handling Unit	≥ 5kW (motor rating)	<u>Input, electrical</u> power (kW)

- (b) Both BEC clauses 6.13.1 and 6.13.2 specify the same set of measuring parameters. For a measurement to be meaningful, the set of parameters in TG Table 6.13(a) above should be taken at **the same instant of time**. The measurement of input power would require the provision of an electrical power meter based on electrical current and voltage, and the measurement of output cooling or heating power would require the provision of a thermal power meter based on water flow rate and temperature difference. The measurement of energy, input or output, would require the power metering to incorporate an accumulative function for the measured data over time and an analytical function to convert the power over successive time intervals into energy terms for adding-up to give the cumulative energy value.
- (c) The energy metering includes the data acquisition instrumentation that captures the raw information of -
- (1) electrical current and voltage for electrical power/energy; and
  - (2) flow or water pressure and temperature for thermal power/energy.

For temperature capturing, the temperature sensor is an instrumentation usually located in a well inside the water pipework, the sensor may be a thermocouple, a resistance temperature detector or a thermister etc.

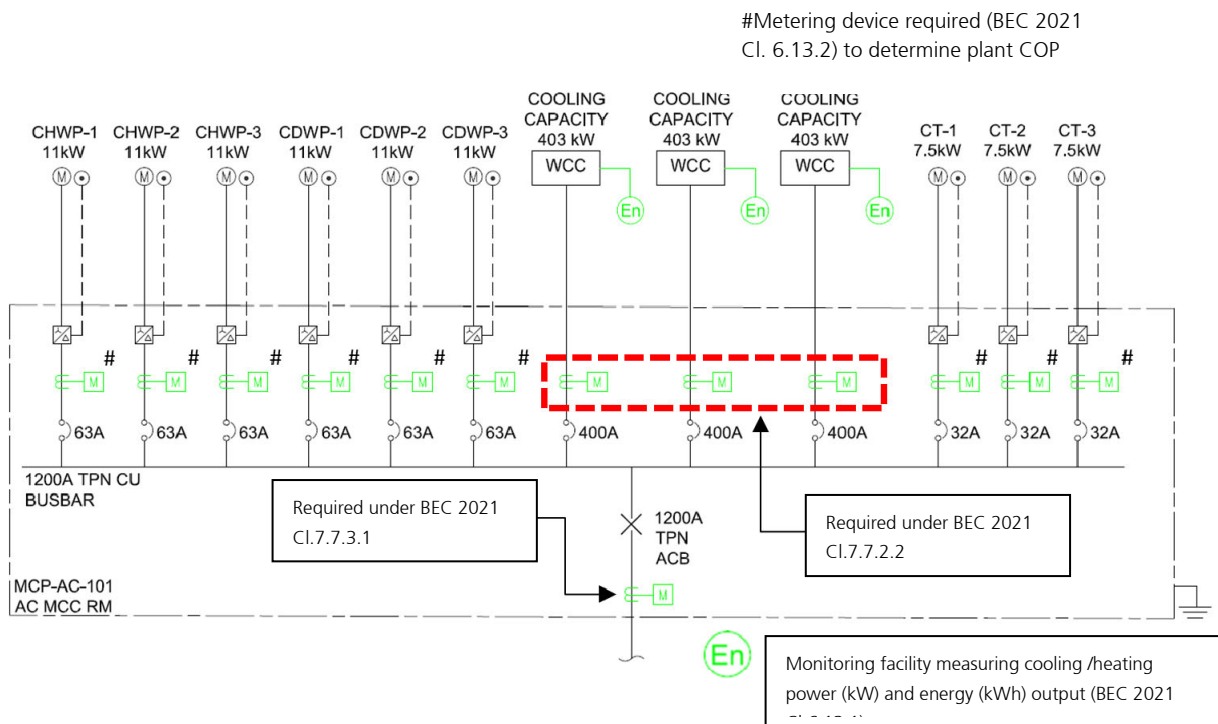
For flow capturing, the instrumentation may be a flow meter of electromagnetic type, ultrasonic type, vortex type, turbine type etc. The instrument should be suitably located, and in particular for water flow sensing should be longitudinally (in respect of pipe run) at certain pipe diameters beyond any in-line sharp bend or transition to avoid over turbulence that may render the measured data inaccurate.

- (d) There are situations that due to limited plant room spacing it is practically difficult to fit in a flow meter to a chiller. BEC clause 6.13.3 addresses to these situations by making use of the gauged water pressure drop across the chilled water tubing of the evaporator to check against the manufacturer's pressure-flow curve to obtain the chilled water flow rate. These flow rate data together with the corresponding chilled water temperature readings at the inlet and outlet of the evaporator can be based upon to calculate the cooling energy output of the chiller. Likewise for a heat pump, its heating energy output can be calculated in a similar manner by making use of the data of pressure drop and temperature difference across its condenser. The pressure difference and hence the water flow measurement should be taken automatically for fulfilling the requirement on continuous monitoring.
- (e) TG Figure 6.13 summaries the requirements on energy metering using a typical chilled water plant with water-cooled chillers while the cooling towers are assumed at the open roof remotely located. The relevant requirements under BEC clause 7.7.2 and 7.7.3 have also been captured for the completeness of the discussion. The metering device downstream the 400A MCCB offering the power consumption for computation of chiller COP should also be able to measure those parameters as prescribed under BEC clause 7.7.2.2.

A metering device upstream the 1200A ACB should be provided for the entire chilled water plant in accordance with the requirement prescribed under BEC clause 7.7.3.1.



**Figure 6.13 – Electrical Schematic Diagram of chilled water plant**



- (f) Having BEC clauses 6.13.1 and 6.13.2 specifying the measurement parameters, BEC clause 6.13.5 sets out the requirements on monitoring facilities in terms of specifying the measurement interval and the data storage capacity. Care should be taken that the logged data serve the purposes of trending, analysing system performance, identifying potential improvement measures or the evaluation of any implemented energy saving measure. In respect of missing data, it is always possible that, for analysis purpose, approximation could be made by interpolation or by referencing the data from the same period of time of the previous year(s). The BEC therefore **does not** mandate any means to secure the monitoring facilities free from missing data through backup provision in form of, for instance, additional battery or UPS.
- (g) The designer should take great care when consider using BMS as the means of collecting data for the computation of chilled water plant’s coefficient of performance. It is noted that the BMS takes and collects data by scanning through the whole network. Therefore, under such mechanism, those collected data are not taken at the same instant and should not be used for the determination of the plant’s coefficient of performance.
- (h) For having the monitoring facilities so setup fulfilling the Code’s requirements, the designer might consider deploying the data logging device equipped with certain features including the support of multi-protocols communication, integrated digital processing element and the capability of handling the required data storage. These allows the data logging device from capturing the electrical power input /

power consumption, thermal energy / power output from different sensing elements and metering devices. The digital processor allows the COP determination based on the measured parameters collected at the same instant of time. The data storage capacity could rely on the internal memory of the data logging device with plug-in communication port allowing downloading of the data to an external device (e.g. hand-held computer). Alternatively, the data logging device could be equipped with replaceable memory card for extending the storage capacity and data retrieval. Certain brands may offer uploading of the data, through wireless communication network, to a remote storage server. Access right to the server is granted to the building owner or the chilled water plant's operator for data retrieval through internet connection. Those retrieved data could then be stored in a workstation or computer for further processing. It could be a value-added benefit by outputting to man-machine interface allowing for graphical display of the collected data with which better analyses of the equipment and plant performance can be conducted. The data may be further transmitted for enhanced monitoring and control, if available, to the central control & monitoring system or BMS with energy management function.

- (i) BEC clause 6.13.6 specifies metering device for each AHU, which being accommodated in a plant room, with individual motor or an array of motors with the rated motor power totaling 5 kW or above. The array of motors refers typically the AHU equipped with multiple plug fans. This BEC clause further specifies the compliance alternative by having the provision of measurement. Care should be taken that when the AHU is not located in a plant room, the requirement on having the metering device or the provision of measurement is **not** mandatory. For the case of providing a metering device with the circuit rating at 200A or below, as a good practice, the data collected by the metering device is suggested to be monitored and stored (by the device's build-in memory or an external storage device) so as to form the energy consumption profile. Such information is useful for identifying any potential energy saving measure and to evaluate the result after the implementation of such measure.

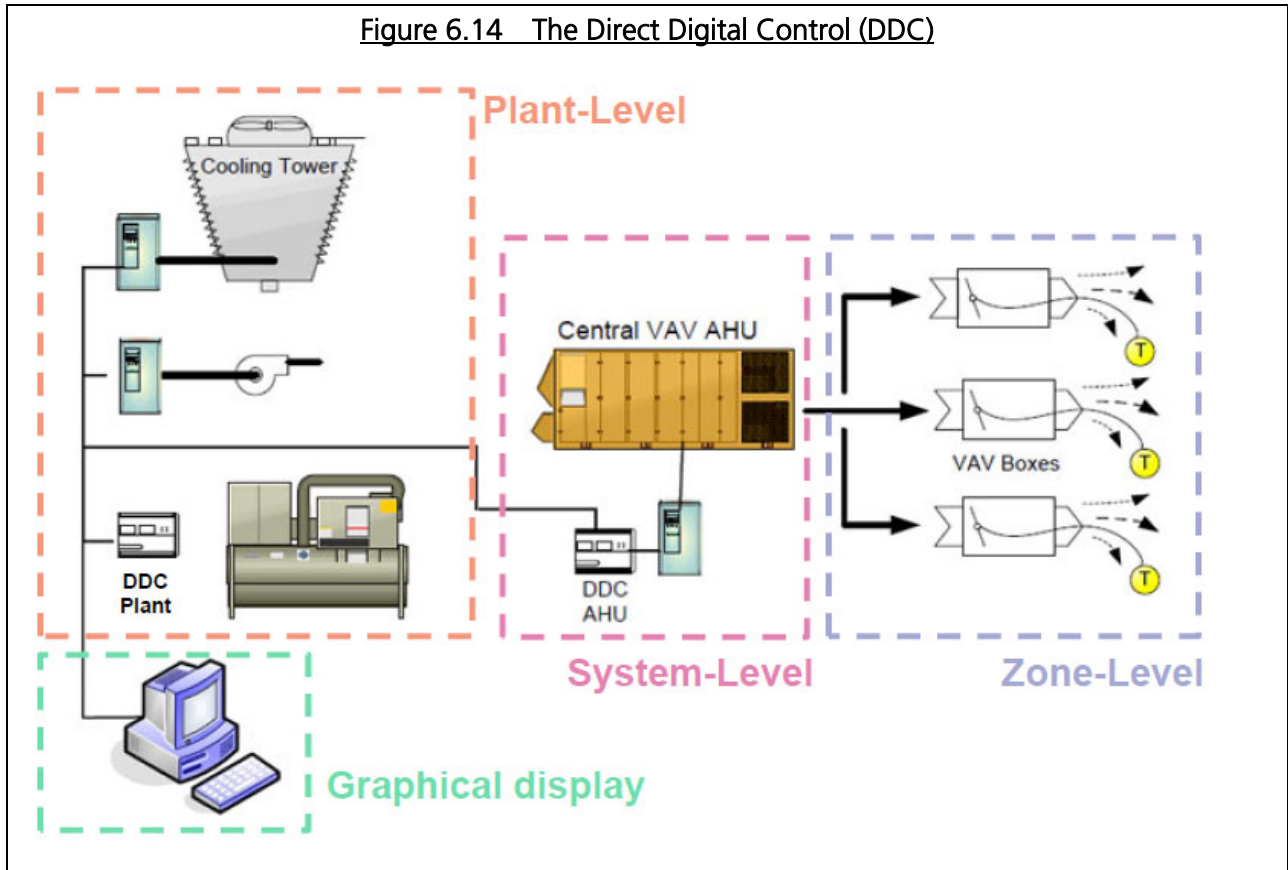
#### 6.14 Direct Digital Control (DDC) (BEC clause 6.14)

##### (a) Direct Digital Control Configuration

The DDC system should monitor zone-level and system-level demand and feedback such necessary information for the air-conditioning system and the chilled/heated water plant to react so as to satisfy the demand requirements. To make it happen, the demand information have to "flow" through the different levels of the DDC via a communication network. Such a basic configuration is presented in TG Figure 6.14.

The BEC does not mandate the architecture or hierarchy of the communication

network but regards it as a proprietary design by the DDC manufacturer. The details of the sensing and activating elements for monitoring and controlling the zone-level, system-level and plant-level demands are under the discretion of the designer/REA.



(b) Direct Digital Control Requirements

BEC's requirements as prescribed under clause 6.14 are summarized in TG Table 6.14 below.

<b>Table 6.14: Provision of DDC</b>		
<u>Equipment / Plant</u>	<u>Capacity</u> (BEC clause 6.14.1)	<u>Capability</u> (BEC clause 6.14.2)
Chilled/heated water plant and all the coils and terminal units served by the plant	≥ 350kW (cooling/heating) serving more than three zones	(a) monitoring zone and system demand for fan pressure, pump pressure, heating and cooling; (b) transferring the zone and system demand to air distribution system controllers and from air distribution systems to plant controllers; and (c) trending and graphically displaying input and output points.
Air distribution system for a conditioned space	System fan motor power ≥ 7.45kW	

BEC clause 6.14.1 mandates DDC requirements on the chilled/heated water plant, the air-conditioning systems (CAV and/or VAV air distribution systems) of an air-conditioning installation. The coils and terminal units served by the plant refers, therefore, to the AHUs, primary air handling units (PAU), control valves and VAV terminal boxes etc.

BEC clause 6.14.2 (a) refers the equipment pressure as the means of monitoring the ON/OFF status of the equipment. As a good practice, the DDC could be enhanced on sensing and monitoring the pressure differential figures offering the crucial data for the evaluation of equipment performance.

Pursuant to BEC clause 6.14.1(b), DDC requirement is applicable to an air distribution system serving a conditioned space. Instead, for PAU(s) connecting to multiple AHUs each serving a conditioned space, the DDC requirement does impose to such PAU(s) for ensuring the system control integrity and completeness. As a good engineering practice, the designer should consider to have the DDC also for each of the AHU serving multiple conditioned spaces to maximize the potential energy saving.

#### 6.15 Chilled Water Temperature Reset

Chilled water temperature reset improves the efficiency of chiller by adjusting the chilled water temperature set point. This clause is not applicable for buildings with connection to district cooling system. For any chilled-water systems with design capacity of 350 kW or above, it must include control (i.e. DDC, BMS, etc) that automatically reset supply water temperature upward at low loads.

Examples for temperature reset:

1. Outdoor air temperature

The chilled water temperature could be reset by considering the outdoor air temperature. An outdoor air temperature sensor should be deployed or by any means to acquire the temperature information from Hong Kong Observatory to obtain the instant / instant interval of outdoor air temperature. Different chilled water temperature could be set depending on the outdoor air temperature.

2. Using building load indicators

The chilled water temperature could be reset by the building load indicators such as return water temperature. The relevant temperature sensor(s) should be deployed to obtain or imply the instant building load.

There is no specific requirement on the scope and extent of temperature reset which is subject to the design and operation conditions. However, it should be careful to maintain humidity control if the coils are used for dehumidification.

## 7. Energy Efficiency Requirements for Electrical Installation

### 7.1 Scope of Application (BEC clause 7.1)

#### 7.1.1 Comprehensive View on Applicability (BEC clause 7.1.1)

BEC Section 7 provides the guidelines for electrical installations. To gain a comprehensive view in relation to the Ordinance, BEC clause 7.1 should be read in conjunction with –

- BEC Sections 3 & 4 that briefly describe the scope and limits of the application of the Ordinance based on its prescribed requirements in Parts 2 & 3; and
- TG Sections 3 & 4 that elaborate on the scope and limits of application and the necessary steps to demonstrate the compliance with the Ordinance and the BEC.

For reference, the interpretation of ‘electrical installation’ under the Ordinance and the BEC is extracted below -

‘Electrical installation’, in relation to a building, means fixed equipment, distribution network or accessories for electricity distribution or utilization in the building;

#### 7.1.2 Examples of BEC Applicable Installations (BEC clause 7.1.2)

In respect of certain types of electrical installations, BEC clause 7.1.2 affirms for the avoidance of doubt the Ordinance’s applicability to these installations, and examples thereof are given in TG Table 7.1.2 below.

<b>Table 7.1.2 : Examples of BEC Applicable Electrical Installations</b>	
<u>Examples</u>	<u>Justifications</u>
Circuit for luminaire, chiller, unitary air-conditioner, AHU, fan, air-conditioning pump, lift, escalator, plumbing pump, sump pump, gondola etc.	BEC clause 7.1.2 (a)
Circuit for lighting solely used for illuminating an exhibit or product on display	BEC clause 7.1.2 (a) (the Ordinance and the BEC applies not to the lighting but to the circuit)
Circuit for exhaust and smoke extract fan serving basement, used for general exhaust during normal operation and for smoke extract during fire mode	BEC clause 7.1.2 (b)
Circuit for maintained type emergency lighting, fireman’s lift (also used for routine service) etc.	BEC clause 7.1.2 (b)

7.1.3 Examples of BEC Non-applicable Installations (BEC clause 7.1.3)

BEC clause 7.1.3 lists certain electrical installations to which the Ordinance does not apply, and examples of these installations are given in TG Table 7.1.3 below.

<b>Table 7.1.3 : Examples of BEC Non-applicable Electrical Installations</b>	
<u>Examples</u>	<u>Justifications</u>
Equipment or cabling at high electrical voltage, such as chiller that operates at 3.3 kV and associated high voltage circuit	BEC clause 7.1.3(a)
Equipment or cabling at extra low voltage, such as of close circuit surveillance TV system, public address system etc. that operate at 24V	
Cabling, exhaust fan etc. that are provided by electricity supplier and installed in consumer's substation	BEC clause 7.1.3(b)
Motor of fire service pump and cabling solely for the pump	BEC clause 7.1.3(c) (fulfilling item 1 of Schedule 2 of the Ordinance)
Cabling solely for lighting solely used for surgical operation, cabling solely for dialysis machine, cabling solely for image-guided radiation therapy etc. (such as in a hospital)	BEC clause 7.1.3(c) (fulfilling item 2(a), 2(b) or 2(c) of Schedule 2 of the Ordinance)
Cabling solely for non-maintained type emergency lighting	Circuit fed by essential power supply and provides supply to equipment or installation which is NOT for routine normal operation. [Electrical installation NOT within the scope of BEC clause 7.1.2(b)]
Cabling solely for an equipment (e.g. in an industrial unit) solely used for industrial manufacturing	BEC clause 7.1.3(c) (fulfilling item 4 of Schedule 2 of the Ordinance)
Cabling solely for a fume cupboard (e.g. in a university) solely used for research, and the fan motor solely serving the fume cupboard	BEC clause 7.1.3(c) (fulfilling item 5 of Schedule 2 of the Ordinance)
Generator set and outgoing cabling	Generator set is not an electrical installation for electricity distribution or utilization
Appliances not fixed in position such as portable desk lamp, portable ventilating fan, flexible extension lead with multi-socket adaptor	Portable appliances are not fixed equipment or fixed distribution network, and are thus not governed by the Ordinance

## 7.2 General Approach (BEC clause 7.2)

The energy efficiency requirements in BEC clauses 7.4 to 7.7 are based on the general approach to energy efficiency given in BEC clause 7.2.

## 7.3 Definitions (BEC clause 7.3)

BEC Section 2 provides the interpretations and abbreviations related to the BEC and the Ordinance, including those for electrical installation.

## 7.4 Power Distribution Loss (BEC clause 7.4)

### (a) Distribution Transformer (BEC clause 7.4.1)

To reduce power losses in transformers, including no-load and load-related  $I^2R$  losses and eddy-current losses, BEC clause 7.4.1 specifies the minimum transformer efficiency for a transformer provided by the developer or building owner, and the efficiency should be based on the testing in accordance with IEC Standard 60076-1 Ed. 2.1. Transformers provided by the electricity supplier are not governed by the BEC. It is common that the winding or copper loss in the transformer varies approximately as the square of the load current, which varies slightly with operating temperature, and the core or no-load loss is more or less steady at constant voltage and frequency.

### (b) Maximum Allowable Circuit Copper Loss (BEC clauses 7.4.2 to 7.4.6)

#### i) General

To minimize the  $I^2R$  losses in electrical circuits, BEC clauses 7.4.2 to 7.4.6 specify the requirements of maximum allowable circuit copper loss in circuits, which are expressed as a percentage of the circuit active power - the percentage circuit copper loss is given by the ratio in percentage, of the total copper losses (in Watt) in the conductors of the circuit and the total active power (in Watt) transmitted along the circuit conductors, when the circuit is carrying the designed circuit current.

To fulfill the requirements, a circuit should be adequately sized. The  $I^2R$  losses are proportional to the resistance of the circuit's conductor, which is governed by its material and length. A circuit's current carrying capacity is also affected by the manner it is fixed, enclosed, clipped on tray, and grouped with other circuits, and the properties of its sheathing materials. In sizing of circuits, one based on conventional voltage drop criteria may not necessarily fulfill the % copper loss criteria, which demand in general a slightly larger conductor cross-sectional area. The losses in a circuit are commonly known as copper losses irrespective of the material of the circuit conductor such as aluminum which is not copper. Illustrative mathematical equations and calculations of



circuit copper losses are also given hereinafter in TG clauses 7.8 and 7.9.

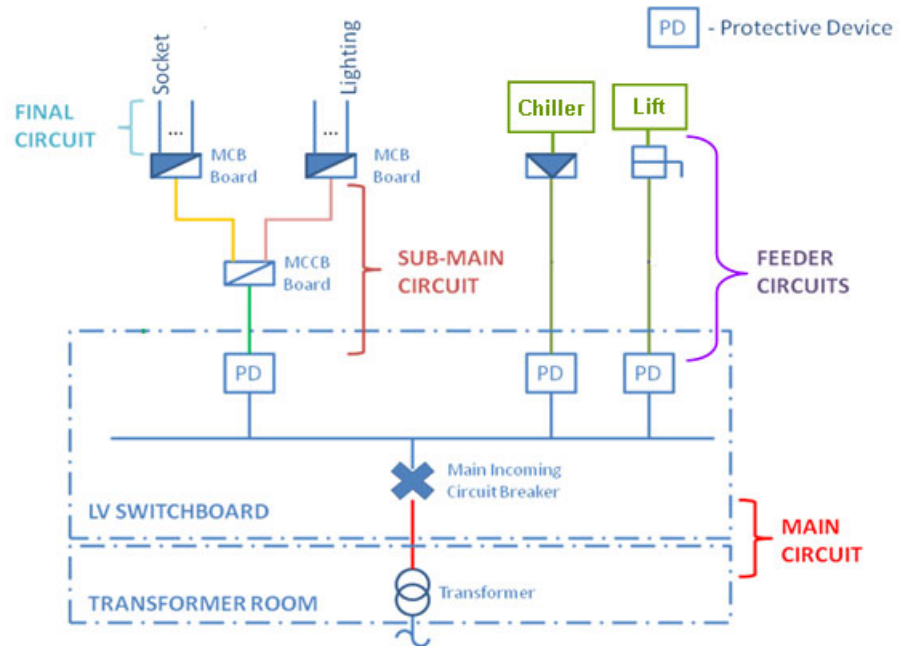
ii) Requirements for Different Types of Circuits

The copper loss requirements are summarized in TG Table 7.4 (b) ii) below for the different types of circuits - main circuit, feeder circuit, sub-main circuit, and final circuit, which are diagrammatically illustrated in TG Figure 7.4 (b) ii) below. Schedule of calculations and corresponding schematics should be submitted for substantiating the compliance with requirements. Layout should be provided for detail checking on request.

<b>Table 7.4 (b) ii) : Summary of Maximum Allowable Circuit Copper Loss</b>			
<u>Circuit Type</u>		<u>Connection</u>	<u>Copper Loss</u>
Main Circuit		Distribution transformer to low-voltage switch board (LV SwBd)	<ul style="list-style-type: none"> <li>- <math>\leq 0.5\%</math>, of total active power,</li> <li style="text-align: center;">or</li> <li>transformer room and main switch room directly beside, above or below each other, and</li> <li>- Neutral conductor to be sized with rating <math>\geq</math> rating of phase conductor</li> </ul>
Feeder Circuit		From LV SwBd, or from isolator after main fuse <sup>@3</sup> of electricity supplier, direct to major equipment	$\leq 2.5\%$ of total active power <sup>@1</sup>
Sub-main Circuit	non-residential building	$\leq 100\text{m}$	$\leq 1.5\%$ of total active power
		$> 100\text{m}$	$\leq 2.5\%$ of total active power <sup>@2</sup>
	residential building		$\leq 2.5\%$ of total active power
Final circuit $>32\text{A}$ (based on circuit protective device rating)		Local distribution board to equipment / outlet point (e.g. luminaire, socket)	$\leq 1\%$ of total active power

**Remarks :**  
 @<sup>1</sup> requirement does not govern a circuit solely used for correction of reactive and/or distortion power  
 @<sup>2</sup> subject to sum of losses in sub-main and over 32 A final circuits, if any,  $\leq 2.5\%$   
 @<sup>3</sup> refers to a mains supply via a direct feed cable of the electricity supplier, which is adopted when the supply does not involve a consumer sub-station.

**Figure 7.4 (b) ii) : Illustration of different types of circuits specified in BEC clause 7.4**



iii) Sub-main Circuit (BEC clause 7.4.4)

Inclusion of all components of a sub-circuit in the calculation of % copper loss

A sub-circuit may consist of a common portion with branch-offs. Consider a sub-circuit with an intermediate distribution board below. The approach in calculating sub-circuit copper loss, sub-circuit active power and sub-circuit % copper loss is shown in TG Table 7.4(b) iii).

Figure 7.4 (b) iii): Sub-circuit with intermediate distribution board

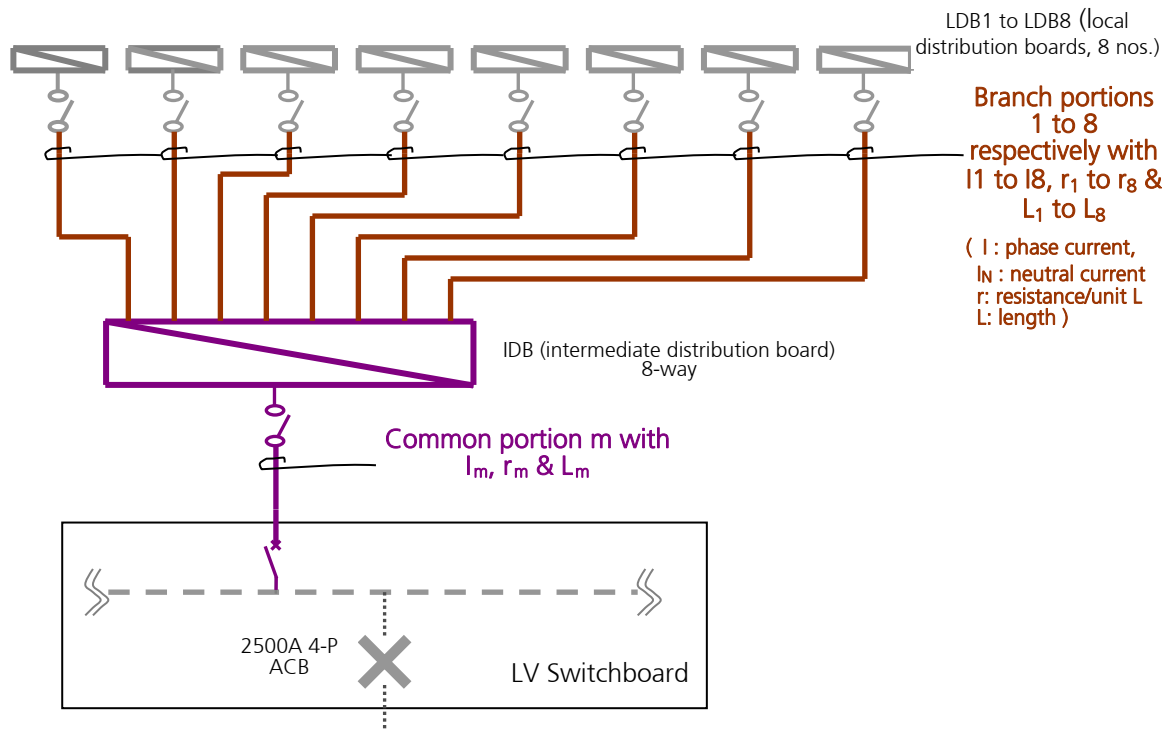


Table 7.4 (b) iii) : Calculation of % Copper Loss of Sub-circuit with Intermediate Distribution Board

( j standing for m, 1, 2, 3, 4, 5, 6, 7 or 8 )	Root Mean Square (rms) Design Current I <sub>jb</sub> (A)	Resistance r <sub>j</sub> (mΩ/metre)	Length L <sub>j</sub> (metre)	Copper Loss P <sub>copper</sub> (W)	Sub-circuit Active Power (W)
<b>Common portion m</b>	I <sub>m</sub>	r <sub>m</sub>	L <sub>m</sub>	$(3 \times I_m^2 + I_{mN}^2) \times r_m \times L_m \times 1/1000$	$\sqrt{3} \times 380 \times I_{m1} \times \cos\theta$
<b>Branch portion 1</b>	I <sub>1</sub>	r <sub>1</sub>	L <sub>1</sub>	$(3 \times I_1^2 + I_{1N}^2) \times r_1 \times L_1 \times 1/1000$	(I <sub>m1</sub> is the value of the fundamental component, and I <sub>m1</sub> ≠ I <sub>m</sub> ; I <sub>m</sub> is the root mean square value of the fundamental and all harmonic components; and cosθ is the displacement power factor.)
<b>Branch portion 2</b>	I <sub>2</sub>	r <sub>2</sub>	L <sub>2</sub>	$(3 \times I_2^2 + I_{2N}^2) \times r_2 \times L_2 \times 1/1000$	
<b>Branch portion 3</b>	I <sub>3</sub>	r <sub>3</sub>	L <sub>3</sub>	$(3 \times I_3^2 + I_{3N}^2) \times r_3 \times L_3 \times 1/1000$	
<b>Branch portion 4</b>	I <sub>4</sub>	r <sub>4</sub>	L <sub>4</sub>	$(3 \times I_4^2 + I_{4N}^2) \times r_4 \times L_4 \times 1/1000$	
<b>Branch portion 5</b>	I <sub>5</sub>	r <sub>5</sub>	L <sub>5</sub>	$(3 \times I_5^2 + I_{5N}^2) \times r_5 \times L_5 \times 1/1000$	
<b>Branch portion 6</b>	I <sub>6</sub>	r <sub>6</sub>	L <sub>6</sub>	$(3 \times I_6^2 + I_{6N}^2) \times r_6 \times L_6 \times 1/1000$	
<b>Branch portion 7</b>	I <sub>7</sub>	r <sub>7</sub>	L <sub>7</sub>	$(3 \times I_7^2 + I_{7N}^2) \times r_7 \times L_7 \times 1/1000$	
<b>Branch portion 8</b>	I <sub>8</sub>	r <sub>8</sub>	L <sub>8</sub>	$(3 \times I_8^2 + I_{8N}^2) \times r_8 \times L_8 \times 1/1000$	

<p><b>Sub-circuit copper loss</b> = <math>\sum P_{\text{copper}}</math> (sum of above 9 portions)          = <math>1/1000 \times \{ [(3 \times I_m^2 + I_{mN}^2) \times r_m \times L_m] + \sum [3 \times (I_{j_b} \times df)^2 + (I_{j_N} \times df)^2] \times r_j \times L_j \}</math> where <math>j = 1</math> to 8</p>
<p><b>Sub-circuit % copper loss</b> = <math>\sum P_{\text{copper}} \div</math> sub-circuit active power          = <math>1/1000 \times \{ [(3 \times I_m^2 + I_{mN}^2) \times r_m \times L_m] + \sum [3 \times (I_{j_b} \times df)^2 + (I_{j_N} \times df)^2] \times r_j \times L_j \}</math>  <math>\div \{ (\sqrt{3} \times 380 \times I_{m1} \times \cos\theta) \}</math></p>
<p><b>Diversity factor <math>df</math></b></p> <p>The diversity factor <math>df</math> of the <b>common portion <math>m</math></b> should be applied to each of the design rms current <math>I_{j_b}</math> (with TPF &amp; THD effect taken into account) flowing through each <b>branch portion</b>. Take for example with design current <math>I_{1_b}</math> to <math>I_{4_b}</math> all being 50A, and <math>I_{5_b}</math> to <math>I_{8_b}</math> all being 60A, and the adoption of 400A for <math>I_m</math>, the <math>df = 400 \div (4 \times 50 + 4 \times 60) = 0.91</math>.</p> <p><math>I_{mN}</math> and <math>I_{jN}</math> denote respectively the neutral current in the <b>common portion <math>m</math></b> and the neutral current in <b>branch portions 1 to 8</b>. The inclusion of the neutral current <math>I_N</math> in this table serves to illustrate that the equations can cater for copper loss calculations involving <math>I_N</math>, which may not be neglected in the case of triplen harmonics or unbalanced single phase loads (discussed respectively in TG clauses 7.6(b) &amp; 7.6 (f)) in three-phase 4-wire circuits.</p> <p>The application of <math>df</math> to the <b>branch portions</b> tallies more with the actual scenario that has the total current in the <b>common portion</b> within 400 A. (The 50 A and 60A in the <b>branch portions</b> should have included the anticipated (or measured) power factor and harmonic currents.)</p>

iv) Feeder Circuit (BEC clause 7.4.3)

A feeder circuit refers to one (usually from the LV switchboard) dedicated to feed a major current-using equipment or a collective group of such equipment. Examples of feeder circuits are –

- circuit dedicated for the central chiller plant such as one running from the LV switchboard and splitting up via a local distribution board (that may be a switchboard itself given the large power drawn by the plant) or motor control centre into its final circuit components to terminate at the various chillers and pumps,
- circuit dedicated for a group of lifts (or escalators) such as running from the LV switchboard and splitting up via a local distribution board or motor control centre into its final circuit components to terminate at the individual lifts (or escalators) of the group,
- circuit dedicated for a group of AHUs (each say driven by a motor exceeding 1 kW), running from the LV switchboard and splitting up via a local distribution board or motor control centre into its final circuit components to terminate at the individual AHUs of the group, or
- circuit dedicated for a group of plumbing/sewage pumps, running from the LV switchboard and splitting up via a local distribution board or motor control centre into its final circuit components to terminate at the individual pumps of the group.

Circuit feeding FCUs or lighting and small power

A circuit running from the LV switchboard feeding a group of FCUs (each usually drawn by a motor of less than 1 kW and usually via plug and socket) and feeding miscellaneous equipment or services is usually not regarded as a feeder. Likewise a circuit running from the LV switchboard and feeding luminaires or power sockets is not regarded as a feeder.

Inclusion of all components of a feeder in the calculation of % copper loss

A feeder circuit may have a configuration similar to that shown in TG Figure 7.4(b)iii) above, except that the branch portions 1 to 8 terminate at, instead of the local distribution boards, the respective current using equipment (i.e. LDB1 to LDB8 are replaced this time with current using equipment). The same approach indicated in TG Table 7.4(b)iii) above should be adopted in the calculation of % copper loss for the complete feeder circuit.

v) Final Circuit (BEC clause 7.4.5)

For final circuits, the copper loss requirement governs those with circuit protective device rating above 32A, meaning that circuits such as for lighting and small power with design current lower than or at 32 A are not governed.

vi) Effect of Power Factor & Harmonics (BEC clause 7.4.6)

BEC clause 7.4.6 specifies that the effects of total power factor (TPF) and total harmonic distortion (THD) of current are to be accounted for in the calculation of % copper loss, which means that the loads of inductive nature and the loads of non-linear nature should be assessed in parallel with conventional resistive loads. In particular for the main circuit, the use of a neutral conductor with cross-sectional area less than that of the phase conductor is not allowed, given the possible large triplen harmonic currents that may exist in the main circuit's neutral conductor in a building with large proportion of non-linear loads that is quite common nowadays.

vii) Residential Buildings & Industrial Buildings Having a Common Area

In respect of a circuit, such as a sub-circuit, passing through or in the common area such as electrical switch room, common cable duct, common corridor etc., the maximum allowable circuit copper loss requirements (TG Table 7.1.2) govern the circuit's CBSI upstream portion in the common area (TG clause 3.1.2). The electricity supplier metering point may be a point to differentiate the CBSI upstream portion of a circuit from its downstream portion which may be regarded as a non-CBSI serving a unit; the demarcation is also mentioned in TG Table 4.2.4(a). The same principle applies to the residential portion of a composite commercial/residential building having a common area.

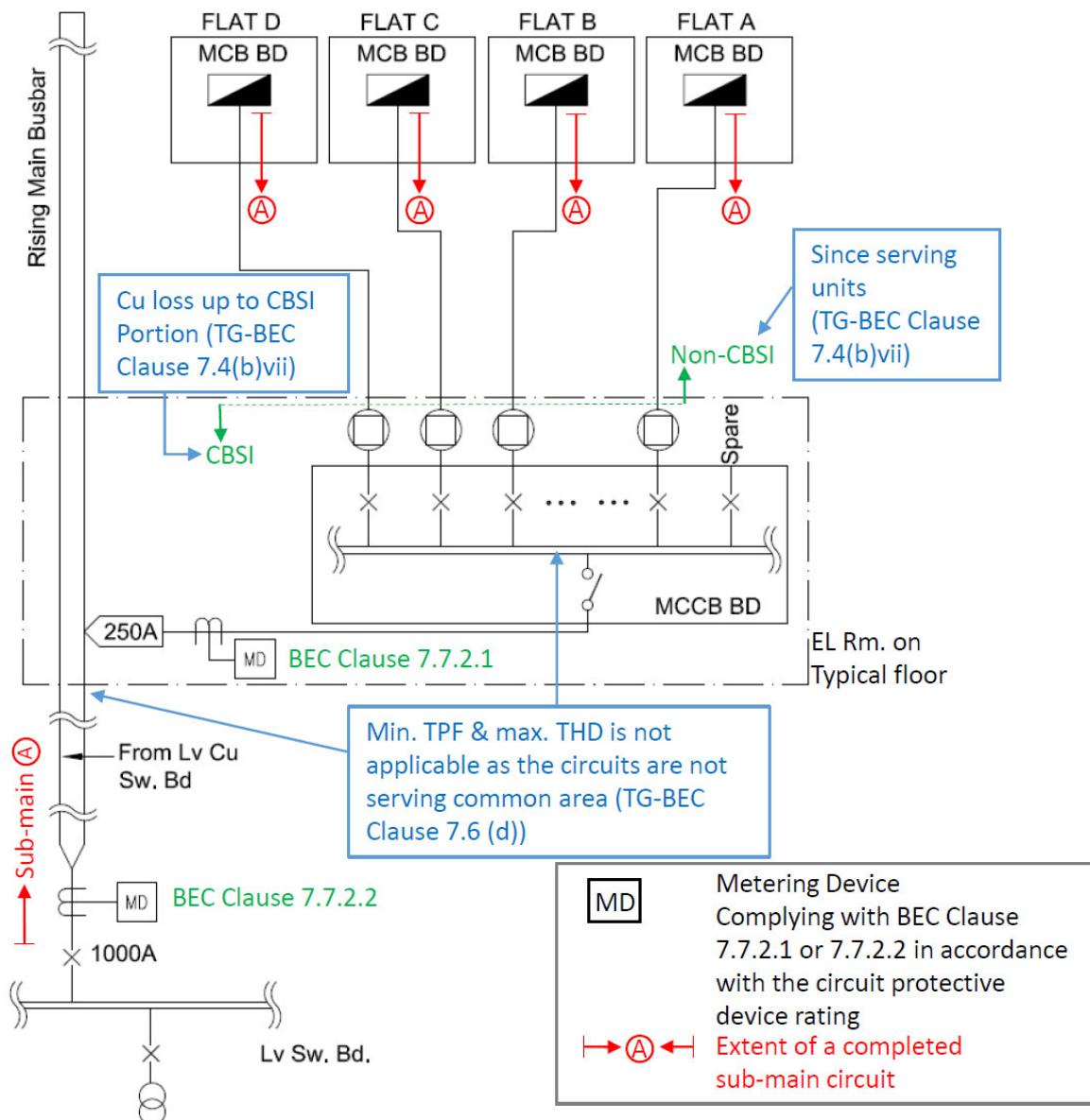
TG Figure 7.4 (b) vii) below indicates the demarcation of CBSI and non-CBSI and the copper loss requirement as discussed on the previous paragraph.

The TG Figures serves also to illustrate the following topics:-

- The sub-circuits serving residential units are not governed by the requirement of minimum allowable TPF and maximum allowable THD as discussed in TG clause 7.6 (d).
- The sub-circuits' CBSI portions are governed under the BEC in respect of metering & monitoring facilities (BEC clause 7.7).

The same principle above applies to industrial buildings and the industrial portions of commercial/industrial composite buildings.

**Figure 7.4 (b) vii) : BEC requirements on sub-circuits serving residential units**



viii) Circuit under Responsibility of Two Parties

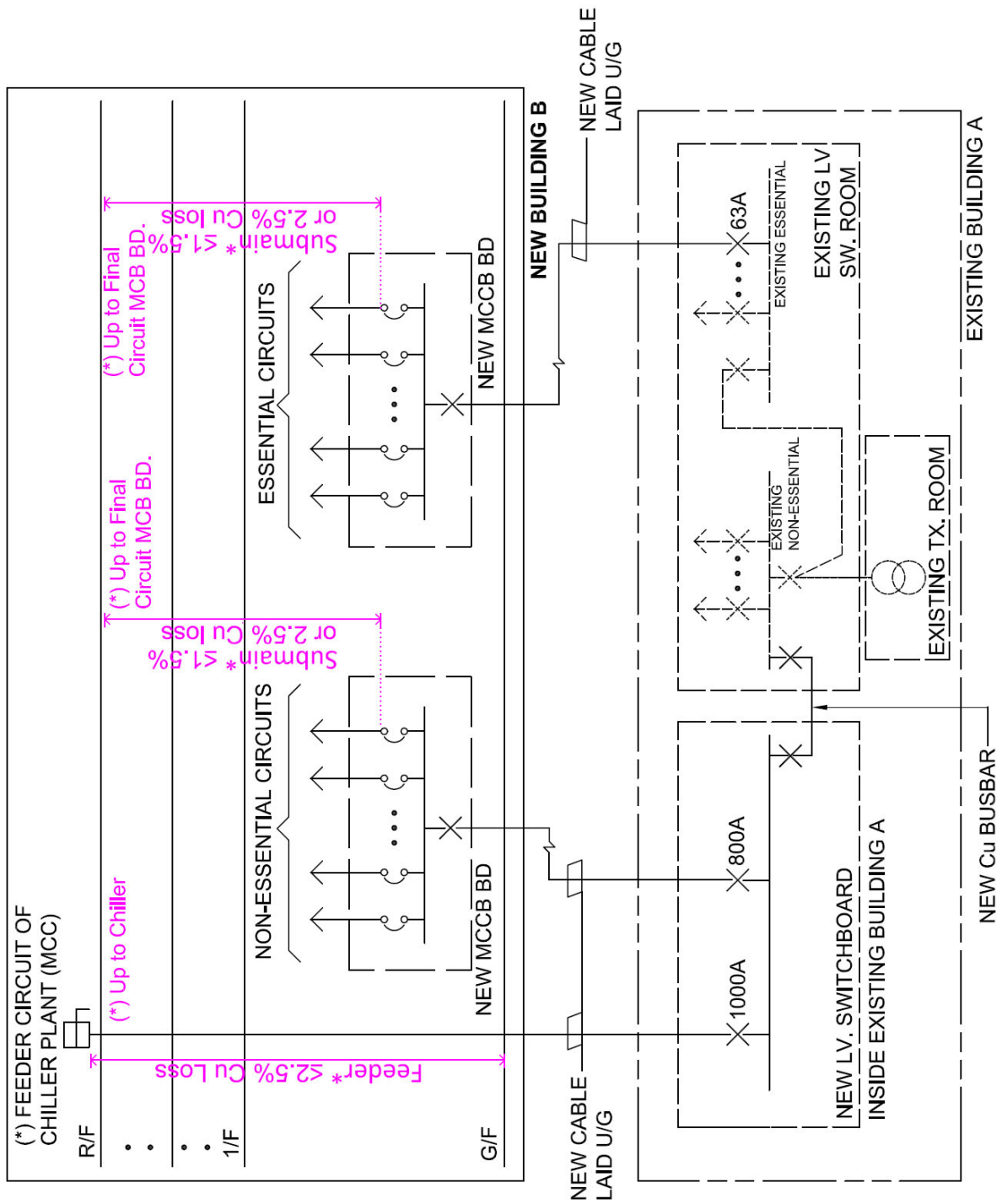
It is common that the upstream portion of a circuit, such as a sub-circuit or feeder, may be installed first, such as by the developer of the building, and its downstream portion at a later date as alteration or retrofitting works by another responsible person. The REA/designer appointed by the developer, building owner or responsible person of the upstream portion should when sizing the circuit include in the calculation of copper loss the future portion (to be installed by the future responsible person) which should be assumed a reasonable cross-sectional area and length. The building owner or responsible person of the upstream portion should maintain a proper record of the sizing and design allowance for copper loss for reference by the future REA/designer and responsible person.

On the other hand, the REA/designer appointed by the responsible person of the downstream portion of the circuit may have it sized with reference to the record (of the upstream portion) if available, which if unavailable the REA/designer should exercise his/her professional judgement to reasonably estimate the copper loss of the upstream portion.

ix) Power Source from another Existing Building

The power supply of a new building may feed from an existing building which already allows capacity and space for future expansion as illustrated in TG Figure 7.4 (b) ix) that a new LV Switchboard being accommodated in the existing building (Building A) feeds the power supply to the new building (Building B) through cable direct bury on grade. In such case, the copper losses of the feeder circuits and sub-main circuits confine at the portion within the prescribed newly constructed Building B. Works being carried out within the existing Building A is not regarded as major retrofitting works, in this case, where involve no complete sub-main or feeder circuits based on the understanding that completed circuits take place out of Building A.

Figure 7.4 (b) ix) : Copper loss requirement for sub-circuits fed from another existing building





(c) Guidelines on Calculation of Copper Loss

Further guidelines on calculation of copper loss are given in TG clause 7.8.

7.5 Motor Installation (BEC clause 7.5)

The requirements in BEC clauses 7.5.1 and 7.5.2 are applicable to general purpose motors, including motors serving fixed equipment such as AHUs, fans, water pumps, gondolas etc. Exemptions are however given to motors serving fire service pumps, motors for high temperature operation, motors of chillers, fan motors of cooling towers etc., as specified in the relevant clauses of the BEC.

7.5.1 Motor Efficiency (BEC clause 7.5.1)

BEC clause 7.5.1 specifies the minimum nominal full-load motor efficiency for single-speed three-phase totally enclosed induction motors, (even it is connected with a variable speed drive) and the efficiency should be based on the testing results in accordance with international standards so specified. The International Electrotechnical Commissions (IEC) has introduced a standard IEC60034-30 related to energy efficiency motors that includes both single speed and variable speed AC motors. Having specified the types of motors governed, there are types not governed, examples of which are given in TG Table 7.5.1 below.

<b>Table 7.5.1 : Examples of Motors Not Governed by Minimum Efficiency Requirement</b>	
<u>Examples</u>	<u>Justifications</u>
Single-phase motor	Not of types included in BEC clause 7.5.1
6-pole three-phase motor	
2-speed motor	
Motor with rated output power < 0.75 kW	
Open type motor	
Motor with brushes, commutators, slip rings or electrical connections to the rotor	Exemption specified in BEC clause 7.5.1
Motor, in a submersible pump, which is enclosed in a waterproof enclosure and cannot be tested separately from the pump	
Motor, of a fan, with motor frame and fan mounting integrated in a single assembly, and cannot be tested separately from the fan	
Motor with operating ambient temperature above 40°C	

Losses in induction motors include losses that vary with the load and those that are relatively constant irrespective of the load, a common split being 70% to 30%. The

electrical energy that is not converted to motion is mostly dissipated as heat. The electrical load losses include the rotor resistance loss, the stator resistance loss and the stray losses. When under no load operation, these copper losses are very small. However once a load is applied, these losses, the  $I^2R$  losses, will increase as the square of the motor current. In addition there are iron losses in the magnetizing circuit of the motor, and these losses, the eddy current and hysteresis losses, are related to voltage and are therefore relatively constant irrespective of load. There are mechanical losses too, which are the friction in bearings, the turbulence around the rotor as it rotates and the windage of the cooling fan. The higher the motor efficiency, the lower would these losses be. Motors are affected by harmonic currents and unbalanced currents; TG clause 7.6 briefly describes the effects.

#### 7.5.2 Motor Sizing (BEC clause 7.5.2)

- (a) BEC clause 7.5.2 specifies an allowable ratio of motor output power to anticipated system load power of maximum 125%, with permission to adopt the closest higher rating motor should the calculated output power not fall within the range of a standard motor. As an illustration of the permission, consider an anticipated system load of 5.8 kW. As 7.25 kW, given by  $5.8 \times 1.25$ , is not within the standard range of motor, a standard motor at 7.5 kW can be selected (where  $7.5 / 5.8$  results in 1.29 i.e.  $129\% > 125\%$ ).

However, the 125% is not a multiplier to be imposed to the anticipated system load. It is solely a criterion to avoid motor oversizing. Consider the anticipated system load of 9.48kW, a standard motor rated at 11kW is selected. The selected motor rating is 116% of the anticipated system load, given by  $11 / 9.48$ , i.e.  $<125\%$ . Consider the anticipated system load of 10.9kW, a motor rated at 11kW should also be selected.

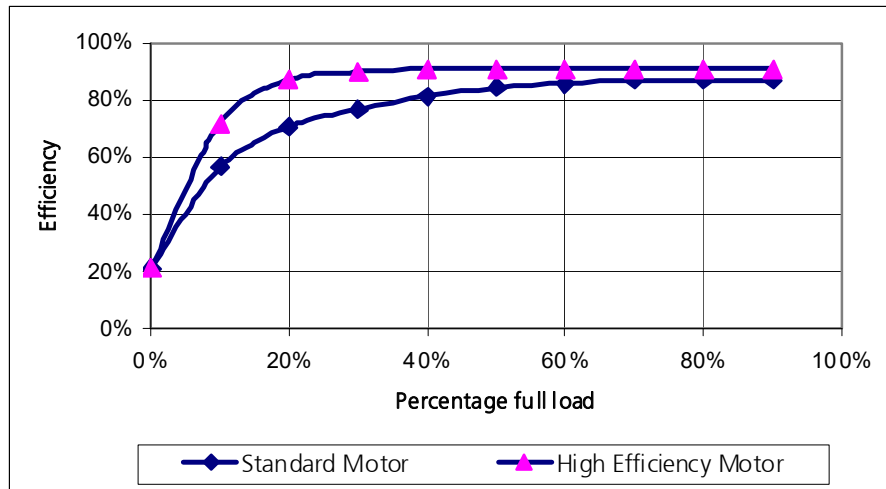
Care should be taken when handling multistage pump motor selection that, given a design water flow rate, the manufacturer may offer a single standard motor rating covering 4 to 5 pump stages where the delivery head difference may vary significantly. As far as the designer/REA demonstrates that such a pump configuration is a must to meet the design duty (typically low flow with high head) and the motor selection procedure has followed the manufacturer's recommended procedure and production standard, such justifications with the supporting selection record should be submitted for the assessment and consideration on the exemption of the 125% criterion.

The maximum allowable ratio requirement does not govern motors of 5 kW or less output power.

Efficiencies of motors vary with size, rating, load and make. TG Figure 7.5.2(a) shows a typical efficiency curve for motors with small to medium output power,

from which it can be seen that the efficiency is close to constant down to about 70% full load and starts to decrease after this point, falling more rapidly at below 40%. It follows that provided motors are running at a reasonably constant load, oversizing by up to 25% will not seriously affect their efficiency, and with the maximum allowable ratio requirement, motors complying with the BEC would be operating at close to their optimum efficiency levels most of the time. On the contrary, oversized motors would operate at the low efficiency range most of the time. Other than consuming more energy to operate the motor, unnecessary motor oversizing would increase the initial cost of the motor itself, and the capital cost of the associated switchgear, starting devices and wiring, and may require higher capital cost for power factor correction (given the motor's power factor falling off more rapidly than its efficiency at reduced loads).

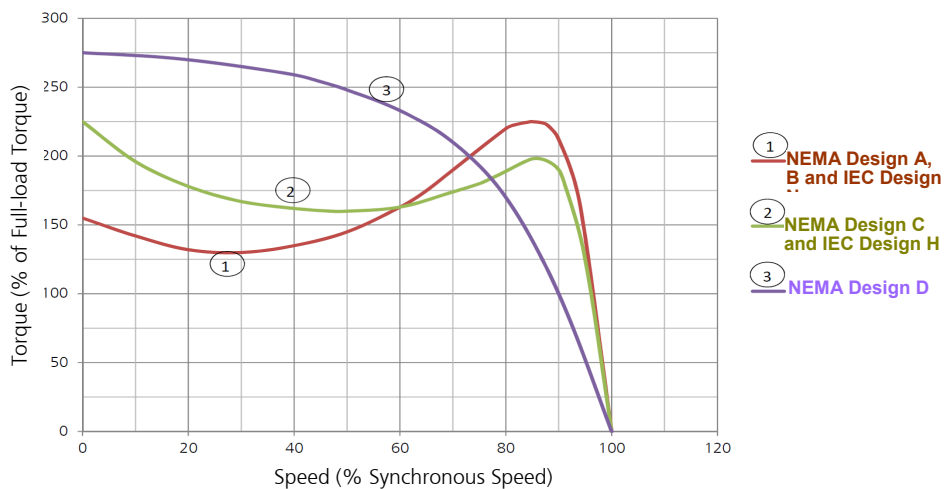
**Figure 7.5.2 (a) : Typical motor efficiency curve for small to medium size motors**



- (b) The maximum allowable ratio requirement governs general purpose motors and does not govern motors for loads that require a high starting torque, such as torque characteristics demonstrated by motors of IEC Design H, NEMA Design C, NEMA Design D or better.

The International Electrotechnical Commission (IEC) and the National Electrical Manufacturers Association, USA (NEMA) classify motors according to speed, torque, current, slippage etc. TG Figure 7.5.2(b) below illustrates typical speed-torque characteristic curves of IEC and NEMA Design motors, in which it can be seen that the NEMA Design C and Design D and IEC Design H motors offer a higher starting torque, for which the sizing do not have to be governed by the maximum 125% ratio requirement.

**Figure 7.5.2 (b) Typical speed-torque characteristics for motors**



7.5.3 Motors for Air-conditioning Equipment, for Fan of Distribution Transformer and for Lift & Escalator (BEC clause 7.5.3)

BEC clause 7.5.3 gives the exemptions from the motor efficiency requirement and the power to load ratio requirement to motors of compressors of chillers or unitary air conditioners, motors of cooling tower fans, motors of ventilation fans integrated with distribution transformers, and motors of lifts or escalators, provided that these equipment comply respectively with the relevant requirements of air-conditioning equipment efficiency, transformer efficiency, and electrical power of lift and escalator. The exemption is based on the rationale that these equipment are already governed in one way or another under the BEC.

7.6 Power Quality (BEC clause 7.6)

(a) General Requirements on TPF & THD (BEC clauses 7.6.1 and 7.6.2)

i) Applicability

BEC clauses 7.6.1 and 7.6.2 specify respectively the requirements on total power factor (TPF) and total harmonic distortion (THD) applicable to a circuit –

- of three-phase and connecting to the electricity supplier’s meter, or
- single or three-phase, at or above 400 A based on circuit protective device rating.

The requirements are, for the circuit when carrying the corresponding designed circuit current –

- a minimum allowable TPF of 0.85, and
- the THD of current, in percentage of the fundamental current of the circuit, to fulfill the corresponding maximum allowable values specified in BEC Table 7.6.2, which is reproduced (with slight reconfiguration) as follows :

<u>Designed circuit current I</u>	$I < 40A$	$40A \leq I < 400A$	$400A \leq I < 800A$	$800A \leq I < 2000A$	$I \geq 2000A$
<u>THD</u>	20%	15%	12%	8%	5%

The THD requirements serve to minimize the I<sup>2</sup>R losses as a result of THD.

ii) Demonstration of Compliance

The demonstration of compliance can be by virtue of –

- a. installing the relevant correction devices, or
- b. installing the relevant connection points (for the correction devices).

The REA/designers should submit relevant drawings such as schematics and

schedule of calculations to substantiate installation locations of the devices / provisions, as well as the estimated harmonics content of the circuits for sizing the correction devices.

iii) Circuits Not Governed

It follows that a circuit –

- having protective device rating lower than 400A and not connecting to electricity supplier's meter, or
- - connecting to electricity supplier's meter but of single-phase is not governed by the requirements.

iv) Correction Devices OR Connection Points for the Devices

The BEC does not mandate the installation of TPF and THD correction devices, as there would be practical difficulties in accurately assessing the capacity of the correction device during design stage at which the actual load characteristics of power factor and harmonics may not be known. Instead, the provision in the circuit of a connection point for TPF and a connection point for THD are specified in BEC clauses 7.6.1.3 and 7.6.2.3. Nonetheless the REA/designer may opt to install the correction devices. To minimize losses in the circuit as a result of low TPF and/or high THD, the correction devices or the connection points should be at the source motor control centre or at the local distribution board. TG clause 7.6 (c) below elaborates on the connection point for correction device.

v) Group Compensation of THD (BEC clause 7.6.2.4)

In the case of a circuit principally for motors with variable speed drives, group compensation of THD for the motors is allowed, provided that the percentage harmonic content of the 5th order harmonics (at the variable speed drive input terminals during normal operation within the variable speed range) is less than 35%. 6-pulse variable speed drives, which are commonly used in variable flow pumps and fans, tend to generate 5th order harmonics with influential magnitude (typically 20% of the fundamental current).

vi) Circuits of Lifts & Escalators

The requirements on TPF and THD do not govern a circuit serving a lift or escalator, provided that the corresponding requirements in BEC clauses 8.5.1 and 8.6 are fulfilled.

(b) Reactive Loads & Non-linear Loads

Electrical loads in a building typically consist of resistive loads, reactive loads and non-linear loads.

Depending on how the power in successive sinusoidal waveforms from the mains source is drawn by the connected load in a circuit, not all the transmitted power are used in doing productive work. For a circuit carrying a simple resistive load, such as a filament lamp bulb or a heater element, the power may be viewed as in the form of a pure sinusoidal wave, and the current and voltage waveforms are in phase, i.e. they change polarity at the same instant successively. For such a load, all the electrical power and energy drawn from the mains source are converted into productive work of light and heat.

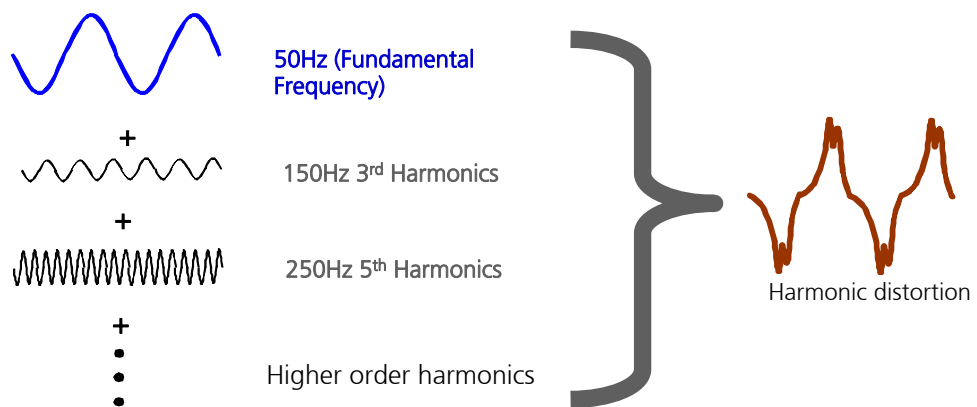
Contrary to the simple resistive load, a reactive load such as an induction motor behaves like a capacitor or inductor. Certain energy from the source or circuit would be temporarily stored by the reactive load at a certain instant of the power wave cycle, and would be returned back to the circuit a split second later in the same cycle. Repeating successively in each cycle, the energy stored and returned is not doing productive work but only adds to the current in the circuit. The term power factor, a ratio ranging from 0 to 1, is used to describe the extent of the productive work of a load. The ratio is given by the real power doing productive work to that of the apparent power that performs both productive and non-productive work, a close to 1 power factor implying an energy efficient load. For a linear circuit, the power factor also equals to the cosine function of the angle shift between the a.c. supply voltage and current in a power triangle. In a circuit supplying power to an induction motor, the current usually lags behinds the voltage. In the BEC, the term TPF of a circuit is interpreted as the ratio of the total active power of the fundamental wave, in Watt, to the total apparent power that contains the fundamental and all harmonic components, in Volt-Ampere. Harmonic current is described in the paragraph that follows.

With the advancement of power electronics, more and more non-linear loads are installed in buildings, typical ones being fluorescent lamps with controlgears, variable voltage variable frequency driving controllers of lifts & escalators, variable frequency variable speed drives for motors, personal computers, printers, fax machines etc., which rely on their built-in SMPS devices to configure the power cycles necessitated for the operation of the load. A SMPS or switching mode power supply device regulates the power from the source to the load, by converting the voltage and current characteristics of the power supply. The device continually switches between intensities of zero, low and full, resulting in the power supply having very little time at its full intensity, which minimizes the overall power and hence the energy drawn.

The change of waveform in a circuit with non-linear loads occurs in respect of both voltage and current. For simplicity purpose, the BEC specifies requirements only on distortion of current and not distortion of voltage, which usually would also be reduced upon improvement of current distortion.

For the non-linear circuit, the mains source current waveform is referred to as the fundamental waveform at the mains frequency, and the actual current in the circuit contains the components that are multiples of the mains frequency. In Hong Kong, the fundamental frequency is 50 Hz. The 2<sup>nd</sup> order harmonics would be at 100Hz, 3<sup>rd</sup> order harmonics at 150 Hz and so on.

**Figure 7.6 (b) i) : Components of harmonic current**



The term THD, in percentage of the fundamental current waveform, is used to describe the extent to which the waveform of the load deviates from its pure sinusoidal form as a result of the summation of all its harmonic effects. The concept of THD is diagrammatically shown in TG Figure 7.6(b) i) above. In equation form, the interpretation of THD of current is given in the BEC Section 2 as –

$$\% \text{THD} = \frac{\sqrt{\sum_{h=2}^{\infty} (I_h)^2}}{I_1} \times 100$$

where :  $I_1$  = root mean square (r.m.s.) value of fundamental current

$I_h$  = r.m.s. value of current of the h<sup>th</sup> harmonic order

The higher the %THD, the more the power or energy would be wasted in the electrical circuit. For a purely linear load, the  $I_h$  would be zero and hence the %THD also zero. With the presence of harmonic currents in a circuit, the apparent power needed to obtain the same active power to do productive work is significantly greater.

Accounting for the effects of TPF and THD, the approach for calculating circuit copper loss is elaborated in TG clause 7.8.

The typical adverse effects of harmonics in electrical circuits include degrading



performance of equipment, overloading neutral conductors, creating unacceptable neutral-to-earth voltage, overheating motor windings, tripping fuses and circuit breakers incorrectly, damaging capacitor banks, causing malfunctioning of electronic equipment, creating undesirable electromagnetic wave interferences, overheating distribution transformers etc.

Given a sinusoidal wave having both polarities, the even order harmonics will usually be canceled. The majority of harmonic currents are odd-order harmonics, i.e. 3<sup>rd</sup>, 5<sup>th</sup>, 7<sup>th</sup> etc. Single-phase equipment such as personal computers and electronic ballasts are significant sources of triplen or odd multiples of the 3<sup>rd</sup> order harmonics i.e. 3<sup>rd</sup>, 9<sup>th</sup>, 15<sup>th</sup>, 21<sup>st</sup> etc., and have magnitudes on the three phases additive in the neutral, resulting in a higher neutral current than the phase current. Harmonic voltages of the 5<sup>th</sup>, 11<sup>th</sup>, 17<sup>th</sup> etc. are negative sequence and would produce adverse effects such as negative torque in motors. The numbers of rectifiers (or pulse number) in an equipment with non-linear electrical characteristics determine the harmonic frequencies it generates. The harmonics, known as "characteristic harmonics" in many rectifiers can be represented using the equation  $h = kq \pm 1$  where  $h$  is the order of the harmonics or harmonic number,  $k$  an integer starting from 1, and  $q$  the pulse number, and have decreasing magnitudes with increasing harmonic number. A 6-pulse variable speed drive (6 rectifiers) would produce 5<sup>th</sup>, 7<sup>th</sup> & 11<sup>th</sup> order (and other higher order) harmonics, each having magnitude respectively approximately 1/5 (0.2), 1/7 (0.143) & 1/11 (0.091) of that of the fundamental current. In terms of THD (when neglecting the other higher order harmonics, which have lower magnitudes), it would be  $\sqrt{I_5^2 + I_7^2 + I_{11}^2} \times 100\% = \sqrt{0.2^2 + 0.143^2 + 0.09^2} \times 100\% = 26.2\%$ . Likewise a 12-pulse drive (12 rectifiers) would generate 11<sup>th</sup> and 13<sup>th</sup> order harmonics with magnitudes respectively approximately 1/11 (0.091) and 1/13 (0.077) of that of the fundamental, and in terms of THD (when neglecting the other higher order harmonics) it would be  $\sqrt{0.091^2 + 0.077^2} = 11.9\%$ .

To have an appreciation of the effect of THD, take for example a 3-phase circuit having a design fundamental current of 100A to be wired with a 35 mm<sup>2</sup> 4/C PVC/SWA/PVC cable on a dedicated cable tray; the ambient temperature is 30°C, the circuit length is 40m, and the load has a DPF of 0.85. If the load is a linear load, the circuit copper loss would be 0.716 kW, whereas if the load has a 38.6% THD, the circuit copper loss would be 1.14kW or about 60% higher.

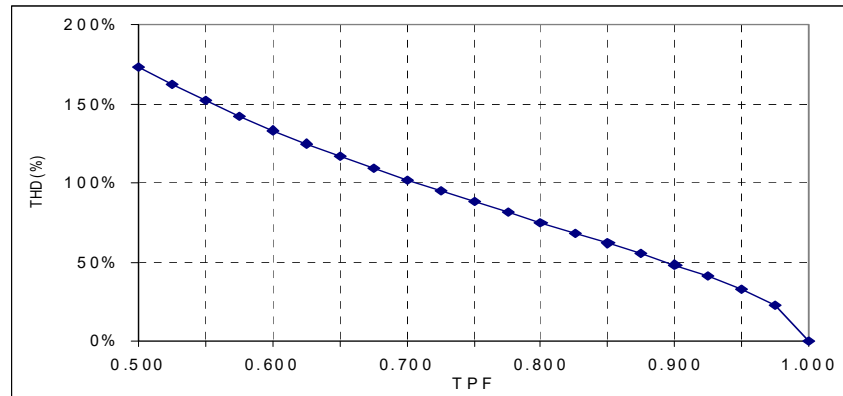
#### Impact of non-linear loads on TPF

In a circuit with non-linear loads, harmonic currents are induced and add to the fundamental current. The relationship between TPF and THD can be represented by the equation below.

$$TPF = \frac{\cos\theta}{\sqrt{1 + THD^2}} \quad \cos\theta \text{ being the displacement power factor (DPF)}$$

It can be seen that for a fixed  $\cos\theta$ , a high THD would result in a low TPF, the correction of which using a harmonic filter would be required. Figure 7.6(b) ii) below gives an indication of the effect of THD on power factor for a unity DPF or  $\cos\theta$ . (TG clauses 7.8.2 and 7.8.3 further describe the TPF and THD calculations.)

**Figure 7.6 (b) ii) : THD (y-axis) versus TPF (x-axis) for non-linear load**

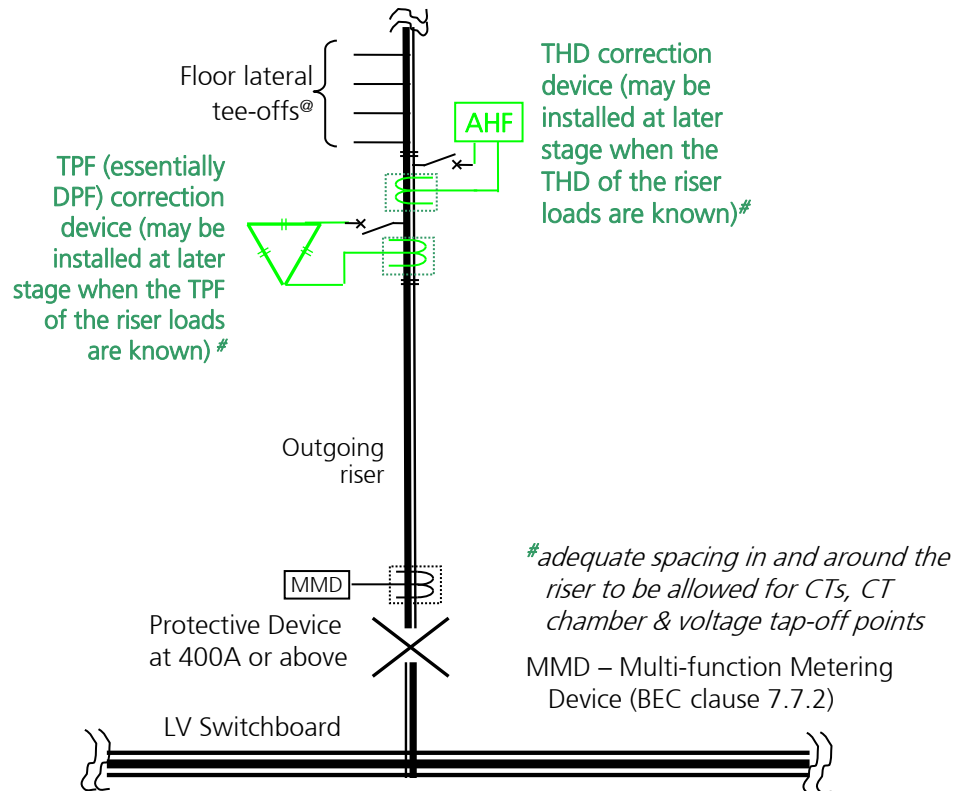


(c) Connection Points for Correction Devices (BEC clauses 7.6.1 & 7.6.2)

i) Circuits at or above 400 A (BEC clauses 7.6.1.2, 7.6.1.3, 7.6.2.2 & 7.6.2.3)

TG Figure 7.6(c) i) below shows the connection points (for TPF and THD correction devices) for a circuit at or above 400 A (circuit protective device rating) based on the requirements in BEC clauses 7.6.1.2, 7.6.1.3, 7.6.2.2 and 7.6.2.3. A common configuration in outgoing circuits of LV switchboard - a riser with floor lateral tee-offs, is used in the illustration. The connection points consisting two spare ways (one for TPF, essentially DPF, and one for THD) of appropriate rating should be installed at a point just before the first lateral tee-off. In parallel with the spare ways, adequate spacing in and around the riser should be allowed for the installation of current transformers (CT), CT chambers and voltage tap-off points for sensing of TPF and THD to operate the correction devices for which adequate spacing should also be allowed.

**Figure 7.6 (c) i) : Connection points (for TPF & THD correction devices) for circuit at or above 400 A**



Alternative to connection points just before the first lateral tee-off

Having indicated above the connection points just before the first lateral tee-off, the REA/designer can choose to provide the connection points –

- at each of the floor lateral tee-offs, or
- at each of the distribution boards downstream of the tee-off (which is a better arrangement as the correction would be closer to the source of the reactive or non-linear loads),

and should such an arrangement be adopted its adoption should be accompanied with adequate space provisions in and around the lateral tee-offs, for the spare ways, CTs, CT chambers, voltage tap-offs etc. for sensing of TPF and THD to operate the correction devices for which adequate spacing should also be allowed.

For a circuit at or above 400A, if all its lateral tee-offs are provided with correction devices or connection points, the requirement of having one upstream at just before the first lateral tee-off would be deemed as having fulfilled. An example of such is a three-phase sub-circuit dedicated for tenant units and having all lateral tee-offs provided with connection points as described in TG clause 7.6(c) ii) below. While it may be the responsibility of the tenant to fix the connection points, the provision of spacing (for the connection points) around the electricity supplier meter would be the responsibility of the building owner if the tenant’s local distribution board is in

the electrical room or meter room.

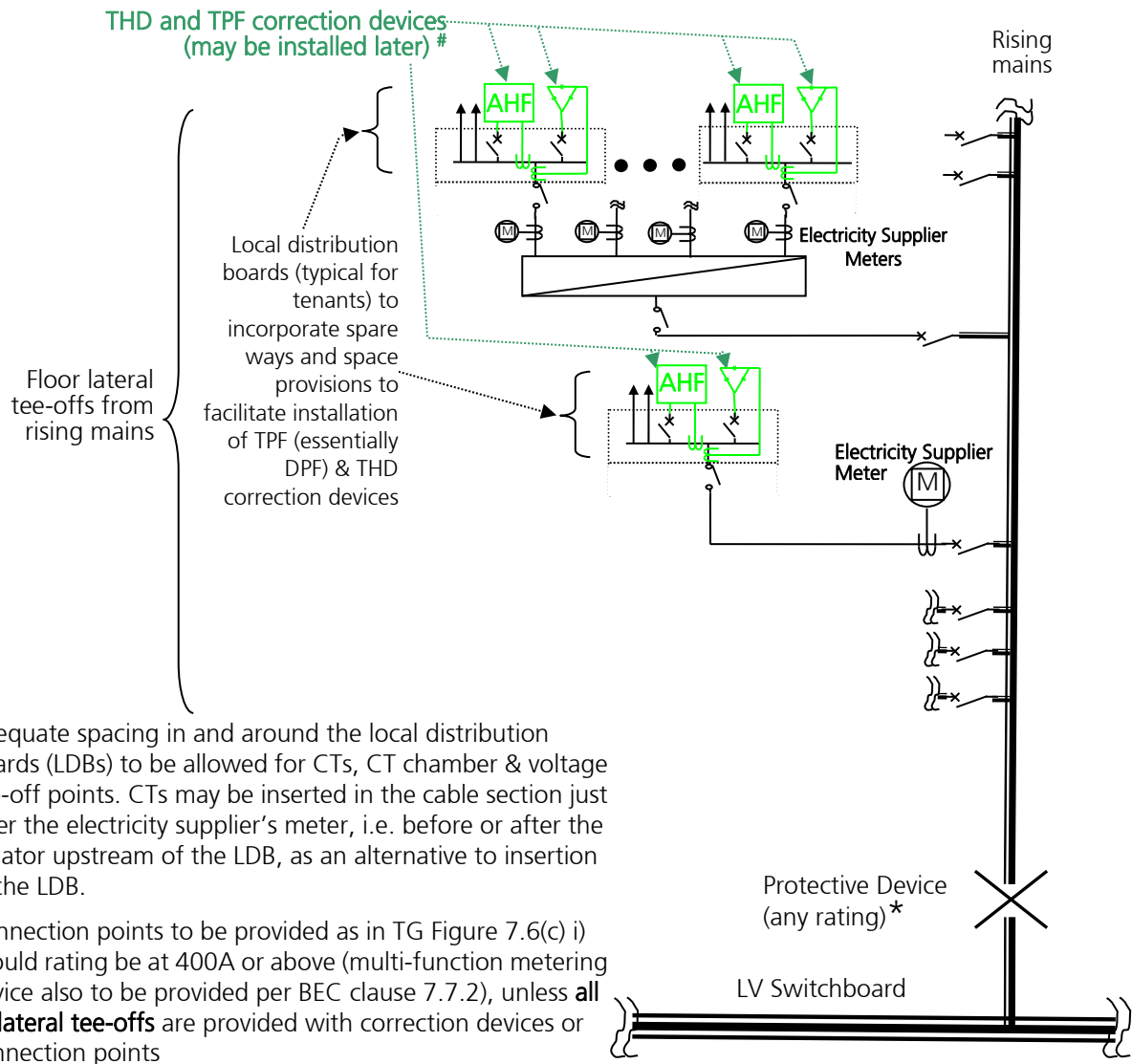
Should there be space constraint for the CT chamber (400A or above) just before the first lateral tee-off, consideration may be given to provide the connection points at each of the floor lateral tee-offs, which demand a lower amperage and thus smaller (physical size) CT chambers.

TG Figure 7.6 (c) iv) provides a further illustration on the connection points for circuit at or above 400A and the associated upstream circuit. At the right hand side of the figure shows two connection points at the 400A Cu chamber (MCP-AC-101 refer) for the 400A infeeding circuit. On the upper left corner, two connection points are installed (at the MCCB BD upstream the 400A TPN MCCB) for the upstream circuit rated at 630A

Nevertheless after the completion of a project, there may be practical difficulty to control the TPF & THD in a circuit for the yet-to-be installed equipment and installations, in particular if the circuit does not involve a electricity supplier meter. Under the circumstance the demonstration of compliance may be by virtue of installing the relevant connection points (TG clause 7.6(a)ii)b. above) at the upstream of the circuit.

- ii) Three-phase Circuits Connecting to Electricity Suppliers' Meters (BEC clauses 7.6.1.1, 7.6.1.3, 7.6.2.1 and 7.6.2.3)

**Figure 7.6 (c) ii) : Connection points (for TPF & THD correction devices) for three-phase circuits each connecting to electricity supplier's meter**



# Adequate spacing in and around the local distribution boards (LDBs) to be allowed for CTs, CT chamber & voltage tap-off points. CTs may be inserted in the cable section just after the electricity supplier's meter, i.e. before or after the isolator upstream of the LDB, as an alternative to insertion at the LDB.

\*Connection points to be provided as in TG Figure 7.6(c) i) should rating be at 400A or above (multi-function metering device also to be provided per BEC clause 7.7.2), unless **all its lateral tee-offs** are provided with correction devices or connection points

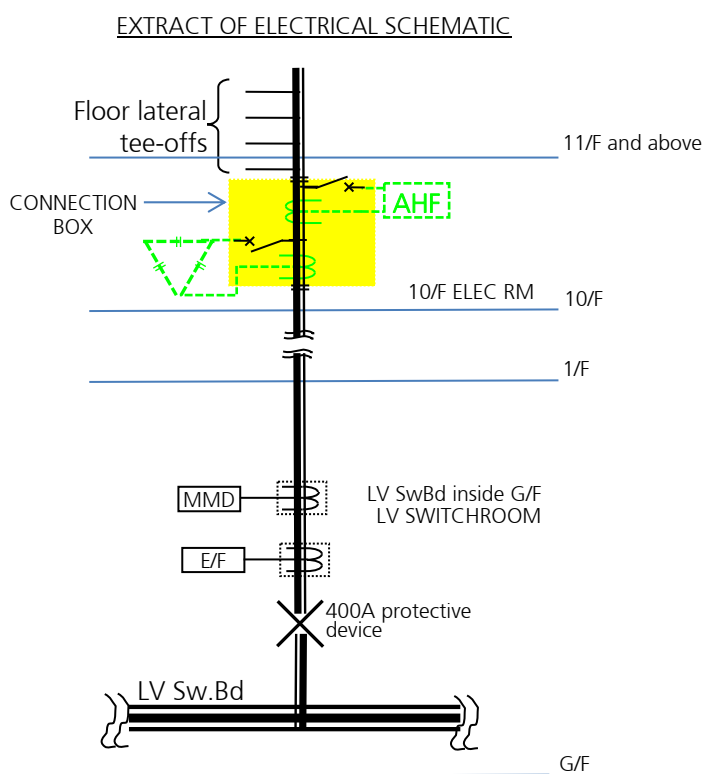
TG Figure 7.6(c) ii) above shows the connection points for three-phase circuits each connecting to the meter of the electricity supplier. The illustration is based on the requirements in BEC clauses 7.6.1.1, 7.6.1.3, 7.6.2.1 and 7.6.2.3. In parallel with the spare ways, adequate spacing in and around the tee-off for the meter or at the distribution board downstream of the meter should be allowed for the installation of CTs, CT chambers and voltage tap-offs for sensing of TPF and THD to operate the correction devices for which adequate spacing should also be allowed.

The above requirement does not apply to single-phase circuits each connecting to the meter of the electricity supplier.

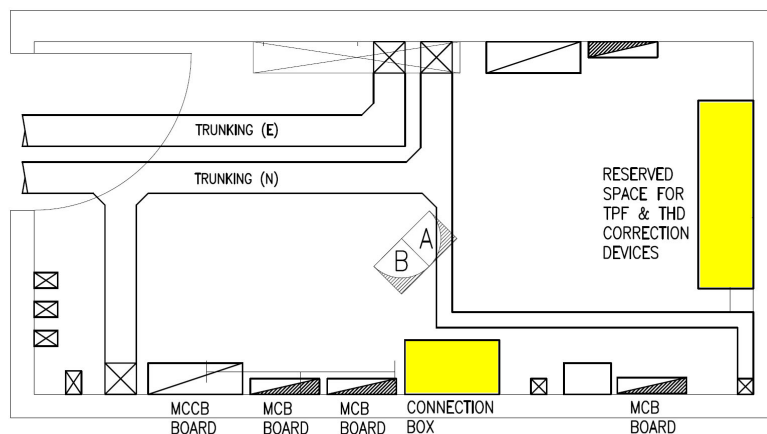
iii) Connection Points to be shown in Drawings

Connection points and corresponding spacing provisions for correction devices should be clearly shown in drawings with both plan and sectional views, a typical illustration based on the configuration at rising mains in TG Figure 7.6(c)i) above is shown in TG Figure 7.6(c) iii) below.

**Figure 7.6 (c)iii) : Typical electrical schematic and layout drawing for connection points at rising mains (with floor lateral tee-offs on 10/F and above floors)**

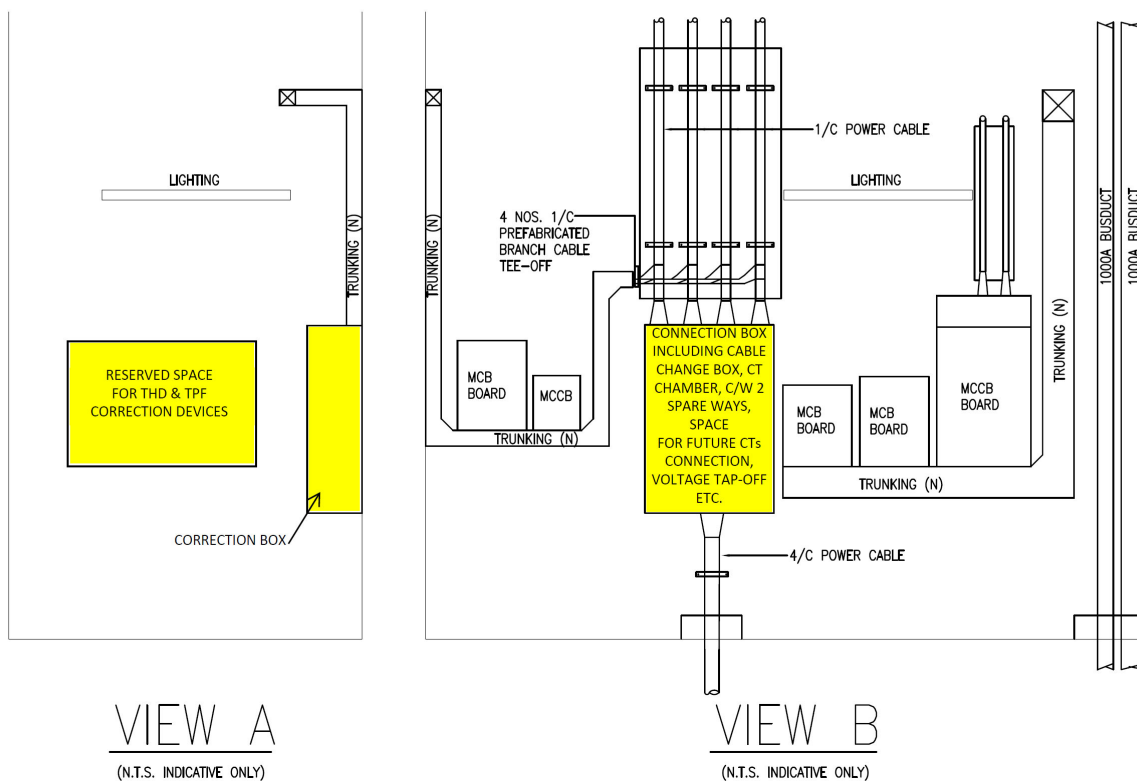


**Figure 7.6 (c)iii (continued)**

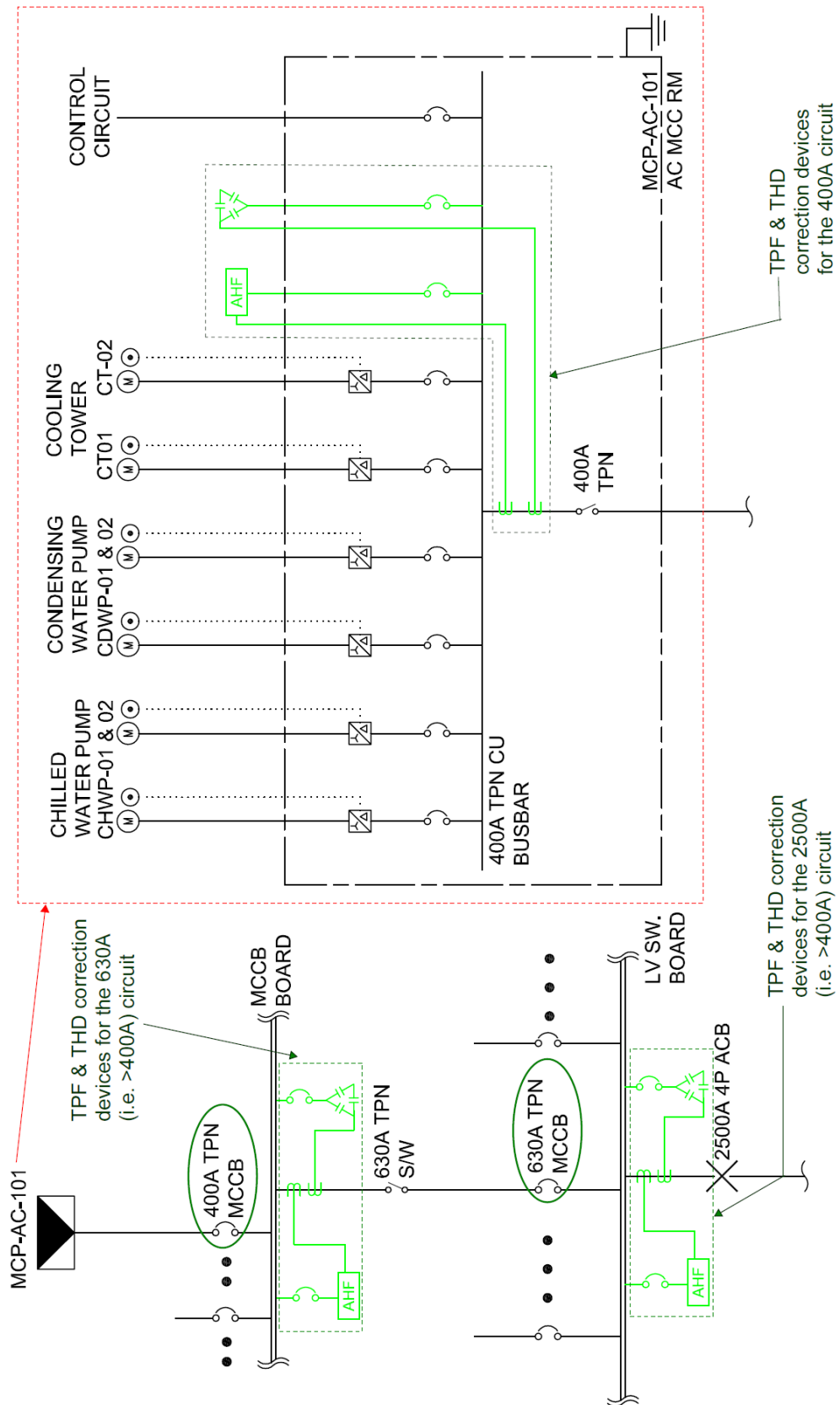


# ELECTRICAL ROOM (10/F)

(N.T.S. INDICATIVE ONLY)



**Figure 7.6 (c) iv) Connection points (for TPF & THD correction devices) for Circuits at or above 400A & the upstream circuits**





(d) Residential Buildings & Industrial Buildings

The intent of the Ordinance is not to govern residential units in residential buildings or in residential portions of commercial/residential composite buildings. It follows that a circuit of a type specified in TG clause 7.6(a)i) serving a residential unit or units is not governed by the requirements of minimum allowable TPF and maximum allowable THD, TG Figure 7.4 (b) vii) acts as a reference; however a circuit of the type serving equipment of the common area is governed. For a building without common area the TPF and THD requirements do not govern its building services installations. The same principle above applies to industrial buildings and commercial/industrial composite buildings.

(e) Electricity Supplier Requirements on TPF & THD

The BEC requirements on TPF and THD tally with similar requirements in the supply rules of electricity suppliers in Hong Kong. The BEC focuses on improving the TPF and THD at the source i.e. the electrical load, and specifies the installation of correction devices close to the source at the motor control centre or local distribution board. The electricity supplier on the other hand pays more attention on limiting the magnitudes of low power factor or harmonic distortion at the consumer's metering point, which has but minimal effects on the I<sup>2</sup>R losses in the circuits downstream of the meter.

(f) Requirement on Balancing of Single-phase Loads (BEC clause 7.6.3)

BEC clause 7.6.3 specifies that for three-phase 4-wire circuits at or above 400A (circuit protective device rating) with single-phase loads, the maximum allowable percentage current unbalance is 10%.

In BEC Section 2, current unbalance in three-phase 4-wire installation is interpreted as –

$$I_u = (I_d \times 100) / I_a$$

where  $I_u$  = percentage current unbalance

$I_d$  = maximum current deviation from the average current

$I_a$  = average current among three phases

Unbalanced Distortion

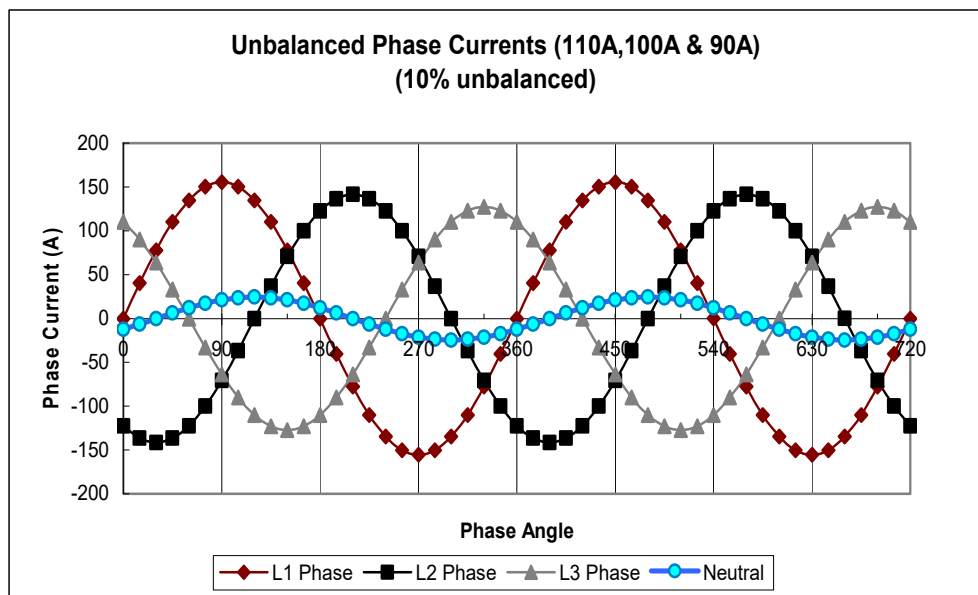
The connection of single-phase loads of different characteristics and power consumption to the three-phase power distribution system may result in unequal currents flowing in the three-phase circuits and unbalanced phase voltages, i.e. unbalanced distortion. Adverse effects of unbalanced distortion include additional power losses and voltage drop in the neutral conductors, reduced forward operating torque and overheating of induction motors, excessive electromagnetic interference to sensitive electronic equipment causing error in power system

measurement etc. In the case of three-phase induction motors, the unbalanced voltage creates an opposing negative sequence component which generates a negative torque that has to be absorbed by the motor at the expense of reduced output.

Single-phase loads are potential sources of unbalanced distortion and should be carefully planned at design stage for balancing. To demonstrate the compliance with the BEC requirement, the REA/designer are required to submit calculations for substantiation.

To have an appreciation of the effect of unbalanced distortion, take for example a 10% unbalanced phase current in a three-phase 4-wire circuit with an average phase current of 100A, as shown in TG Figure 7.6 (f) below. The unbalanced distortion would produce a neutral current of about 17A and increase the total copper loss by about 1%. The effect of the 10% unbalanced distortion and the presence of harmonic distortion if say at 30% would produce a neutral current almost the same magnitude as the phase current resulting in much higher losses.

**Figure 7.6 (f) : Diagrammatic illustration of 10% unbalanced phase current**



### 7.7 Metering & Monitoring Facilities (BEC clause 7.7)

Aiming at achieving the purpose in BEC clause 7.2.2, BEC clause 7.7 specifies the requirements on metering and monitoring facilities for the different types of circuits and charging facilities for electric vehicles, which are reproduced in TG Table 7.7(i) below.

The metering and monitoring facilities have to be physically installed, and the provision of hand-held meters only would not be regarded as meeting the requirement. While simple ammeters and voltmeters can measure currents and voltages that are sinusoidal,

they alone cannot give accurate readings when harmonics are present and cannot give readings of energy, maximum demand, TPF and THD, which have to rely on meters with data-logging and analytical function, such as a digital power analyzer or multi-function meter complete with current transformers (CT) to measure the line currents. The meters should be able to measure the parameters with true root mean square values.

In measuring the phase and neutral line currents, the four CT configuration that employs for each phase and neutral line a CT is a better option than the three CT configuration that employs only three CTs, one for each phase, with the value for the neutral calculated by the metering device; the three CT configuration given its popularity is an acceptable means for circuits not having heavy harmonic loads. As a good engineering practice, the measured data may be transmitted for enhanced monitoring and control to the central control & monitoring system or BMS with energy management function. The REA/designers should submit relevant drawings such as schematics to indicate the metering provisions and technical document such as catalogue to substantiate the compliance with the requirements.

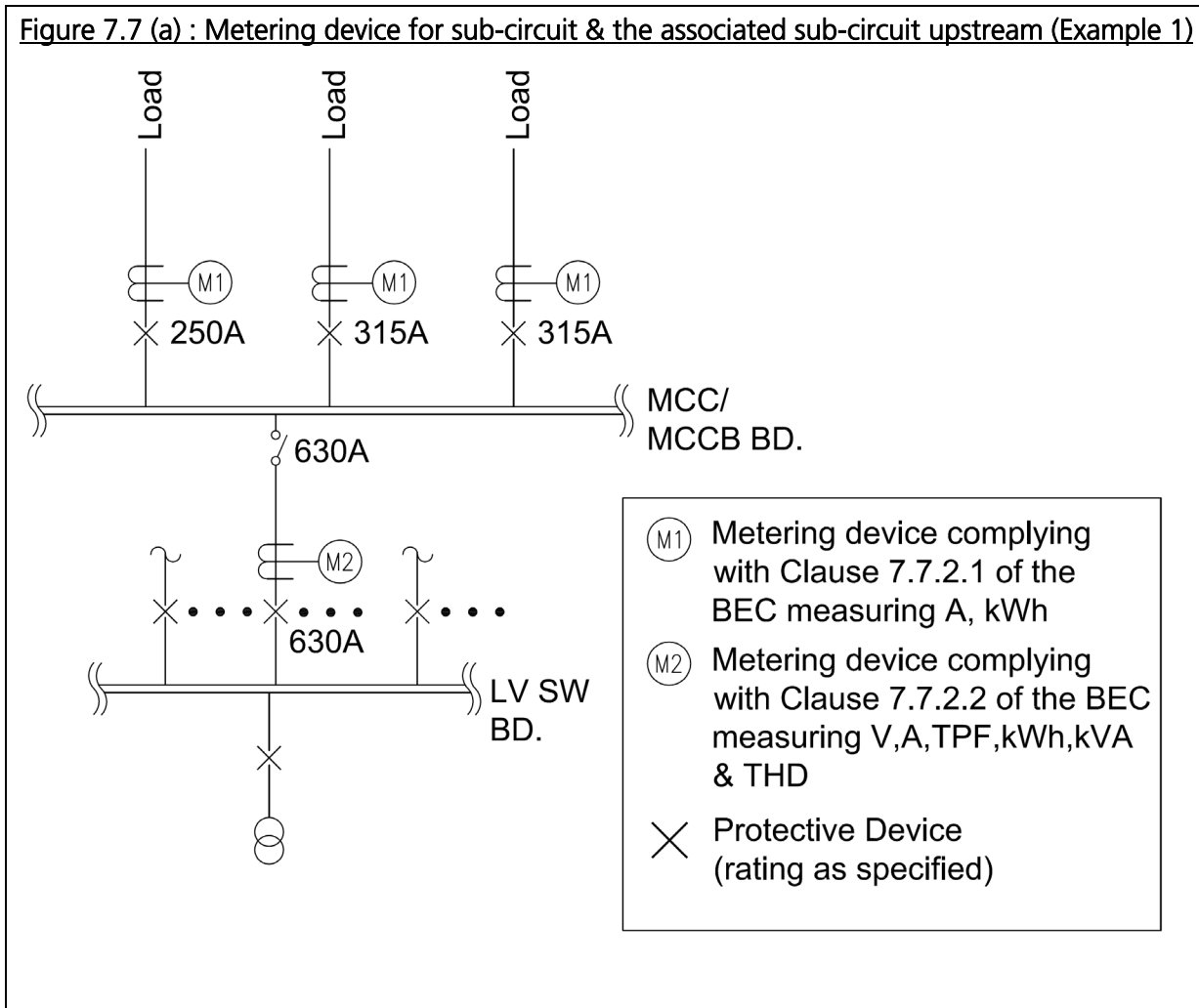
BEC Clause 7.7.5 specifies a minimum of 36 months data storage. The data storage methodology should not be limited to building management system (BMS). Data loggers, which has the capacity to store 36 months data where measurement parameters are trended every 15 minutes, is also allowed for fulfillment of the clause. In general, the build-in memory of the data logger can provide 3 years storage capacity for 15 minutes trending interval. The requirement only applies to mandatory metering device, as stipulated in clause 7.7.1 to 7.7.3. The code requirements are for analysis, identifying potential improvement works or evaluation of implemented energy saving measures. Securing every single data set may not be required such as data loss due to power disruption.

For data logger installation, it is recommended that one data logger should be connected up to 15 power meters for circuit with 200A or above, except for lift system power meter. Attention is drawn to the communication protocol of the data logger which may directly affect the maximum number of connection point. To minimize the wiring connection for metering, data logger capable to upload data to "cloud" can be considered for wireless data transfer.

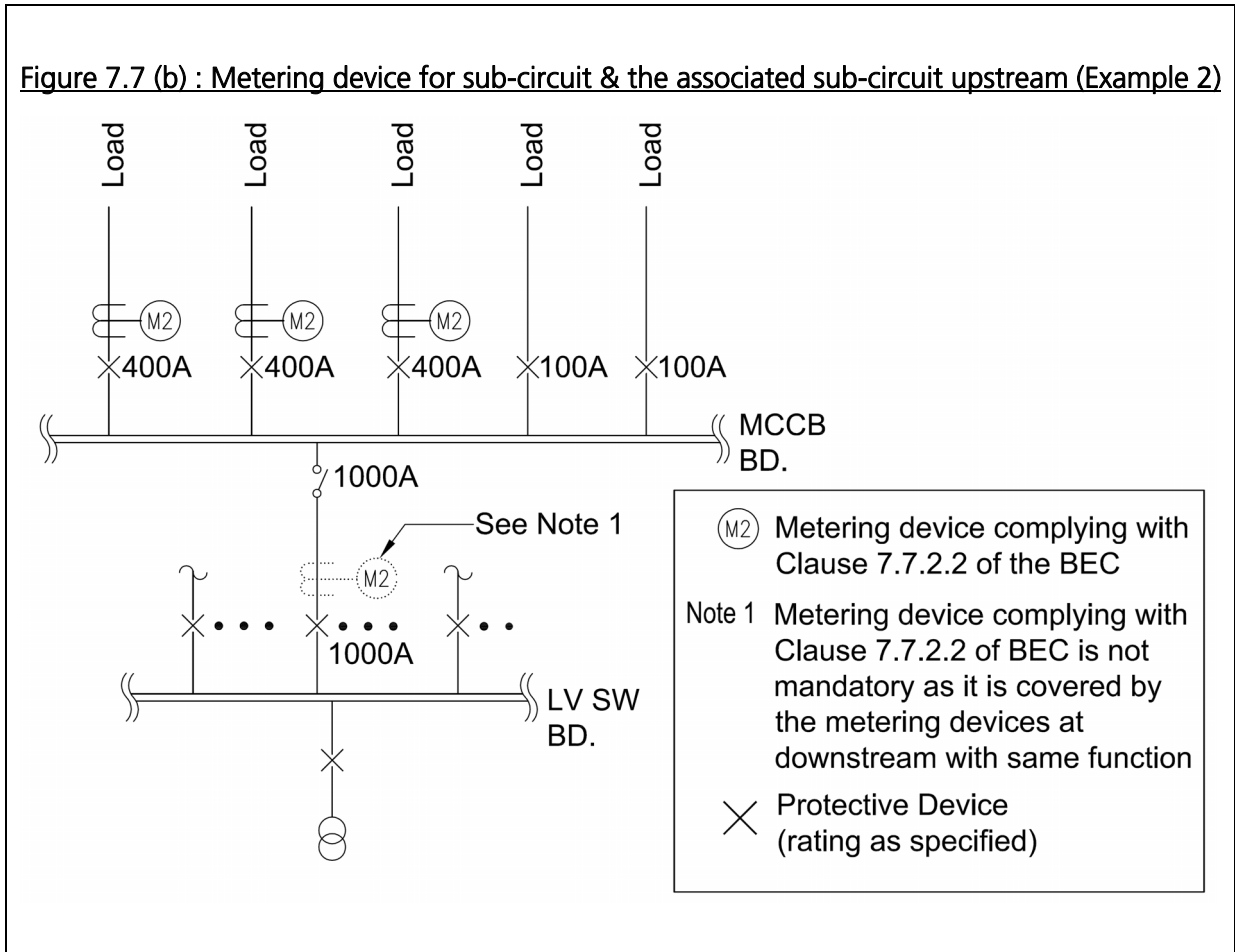
<b>Table 7.7 (i) : Parameters Requiring Measurement in Different Types of Circuits</b>		
<u>Type of Circuit</u>	<u>Circuit Protective Device Rating I</u>	<u>Metering Devices for Measuring the Following Parameters</u>
Main Circuit	I ≥ 400A (single or three-phase)	<ul style="list-style-type: none"> <li>- Voltages (all phase-to-phase &amp; phase-to- neutral)</li> <li>- Currents (three phases and neutral)</li> <li>- Total energy consumption (kWh)</li> <li>- Maximum demand (kVA)</li> <li>- TPF</li> <li>- THD (capable of measuring 31<sup>st</sup> and lower harmonic order)</li> </ul>
Feeder and Sub-main Circuit (except for correcting reactive/ distortion power)		
	200A < I < 400A (single or three-phase)	<ul style="list-style-type: none"> <li>- Currents (three phases &amp; neutral)</li> <li>- Total energy consumption (kWh)</li> </ul>

Examples for metering provision to feeder & sub-main circuits are illustrated in TG Figure 7.7(a) & (b). For TG Figure 7.7(a), metering devices complying with BEC clause 7.7.2.1 are provided for the sub-circuits rated at 250A & 315A. The sub-circuit upstream rated at 630A is provided with metering devices complying with BEC clause 7.7.2.2 disregard the fact that the sub-circuits downstream are all equipped with metering devices. For Figure 7.7(b), metering devices complying with BEC clause 7.7.2.2 are provided for the sub-circuits rated at 400A. The provision of metering device for the 1000A sub-circuit upstream, in this case, is not mandatory based on the understanding that the devices, if provided, duplicate the measurement of those parameters already recorded by the devices downstream.

Figure 7.7 (a) : Metering device for sub-circuit & the associated sub-circuit upstream (Example 1)



**Figure 7.7 (b) : Metering device for sub-circuit & the associated sub-circuit upstream (Example 2)**



In view of the increasing number of charging facilities for electric vehicle found in new / existing building, the code is updated to include the metering devices for charging facilities of EV for separating the energy consumption from building and transportation. An example for metering for charging facilities of EV are included in TG Figure 7.7(c). There are two cases for the metering of charging facilities of EV:

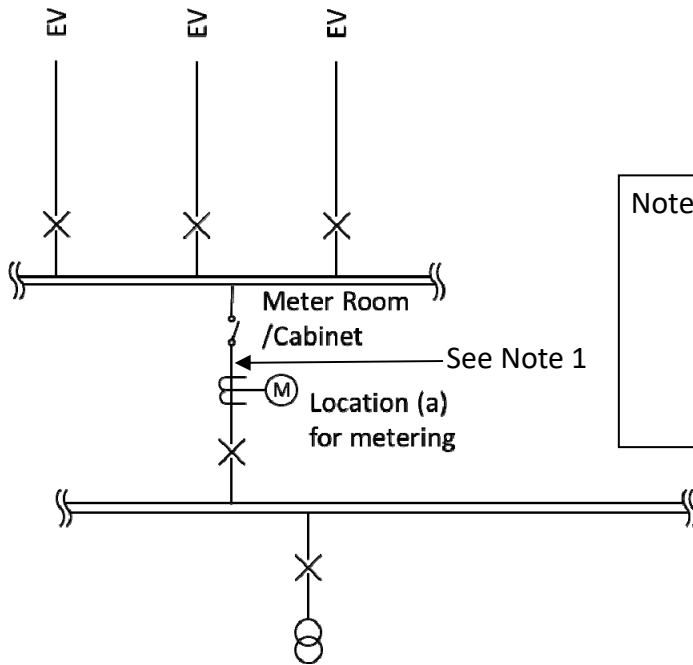
Case (i) - Circuit that is solely for the charging facilities of EV

Case (ii) - Circuit that is not solely for the charging facilities of EV

For Case (i), the metering could be provided at location (a) at Figure 7.7(c) to measure the total energy consumption of the entire charging facilities of EV of the building. However, for Case (ii), as there is part of the outgoing circuit(s) used for other purposes, the designer/REA should identify suitable locations (such as locations (b) at Figure 7.7(c)) for the provision of metering devices at downstream circuit, which the total electricity consumption of charging facilities of EV of the building could be measured and record separately for the compliance of BEC Clause 7.7.3.1(e).

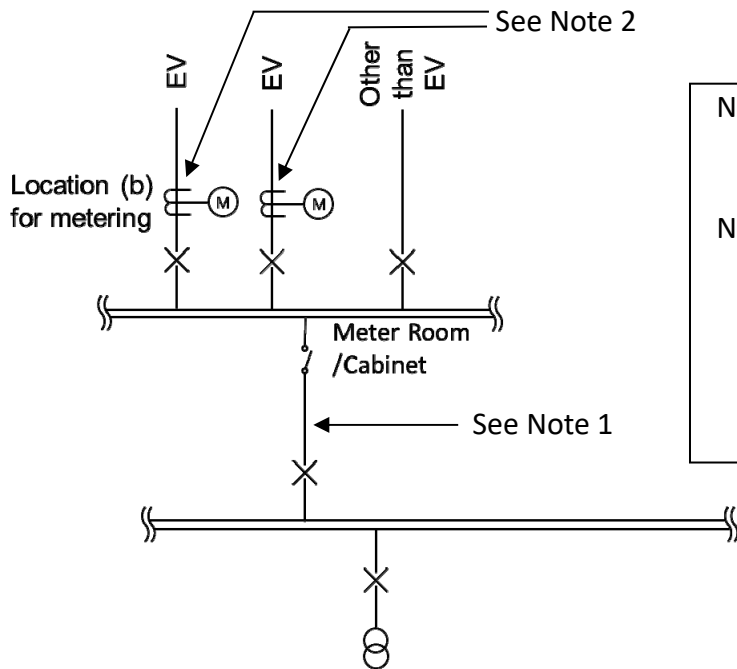
**Figure 7.7 (c) : Metering device for charging facilities of EV**

**Case (i)**



**Note 1** As the circuit is solely for the charging facilities of EV, a metering device installed at location (a) could monitor the charging facilities for EV and fulfilled BEC Clause 7.7.3.1(e)

**Case (ii)**



**Note 1** The circuit is not solely for the charging facilities of EV

**Note 2** In order to fulfill the requirement as per BEC Clause 7.7.3.1(e), metering devices are provided at location (b) to monitor the circuit that solely for charging facilities of EV

## 7.8 Guidelines on Calculation of Copper Loss

### 7.8.1 Conductor Resistance

TG Table 7.8 below tabulates the conductor resistance values for cables of types and configurations listed in Appendix 6 of the Code of Practice for the Electricity (Wiring) Regulations issued by EMSD (2009 Edition, hereinafter abbreviated as “Wiring Code”) that gives the cables’ voltage drop figures (mV/A-m), which are converted into their corresponding conductor resistance figures by dividing by a factor of  $\sqrt{3}$ . (The contents of Appendix 6 are a reproduction of relevant contents in BS7671 – IEE Wiring Regulations, of British Standards Institution (BSI) and The Institution of Engineering & Technology (IET).) It is the intent of the TG to give the resistance values of the common but not all types of conductors. In general, voltage drop figures in catalogues of cable or busbar manufacturers, without prejudice to any governing conditions if any so stated therein, may be divided by a factor of  $\sqrt{3}$  to give the resistance figures.

The conductor resistance (m $\Omega$ /m) figures can be based upon in the sizing of cable for fulfilling the requirements on maximum allowable percentage copper loss.



<b>Table 7.8 : Conductor (copper) Resistance for PVC and XLPE Cable at 50 Hz Single-phase or Three-phase a.c.</b>						
Conductor cross- sectional area (mm <sup>2</sup> )	<b>Conductor Resistance (mΩ/m)</b>					
	<b>Multicore Armoured &amp; Non-armoured #1</b>		<b>Single-core PVC/XLPE Non-armoured, with or without sheath #2</b>			
	PVC cable at max. conductor operating temperature of 70°C	XLPE cable at max. conductor operating temperature of 90°C	PVC cable at max. conductor operating temperature of 70°C		XLPE cable at max. conductor operating temperature of 90°C	
			Enclosed in conduit/ trunking	Clipped direct or on tray, touching	Enclosed in conduit/ trunking	Clipped direct or on tray, touching
1.5	14.4	15.6	14.4	14.4	15.6	15.6
2.5	9	9	9	9	9	9
4	5.5	5.8	5.5	5.5	5.8	5.8
6	3.70	3.93	3.70	3.70	3.93	3.93
10	2.2	2.3	2.2	2.2	2.3	2.3
16	1.4	1.4	1.4	1.4	1.4	1.4
25	0.866	0.924	0.866	0.866	0.924	0.924
35	0.635	0.664	0.635	0.635	0.664	0.664
50	0.462	0.497	0.468	0.462	0.502	0.497
70	0.318	0.341	0.323	0.318	0.346	0.341
95	0.237	0.248	0.242	0.237	0.254	0.248
120	0.191	0.196	0.191	0.185	0.202	0.196
150	0.150	0.162	0.156	0.150	0.167	0.162
185	0.121	0.127	0.127	0.121	0.133	0.127
240	0.095	0.101	0.098	0.092	0.107	0.098
300	0.078	0.081	0.081	0.075	0.087	0.081
400	0.058	0.066	0.069	0.061	0.072	0.064
500	-	-	0.058	0.050	0.058	0.052
630	-	-	0.046	0.042	0.051	0.043
800	-	-	-	0.035	--	0.036
1000	-	-	-	0.030	-	0.032

#1 Based on Tables A6(2), A6(4), A6(6) & A6(8) in Appendix 6 of Code of Practice for the Electricity (Wiring) Regulations issued by EMSD, 2009 Edition (Wiring Code)  
 #2 Based on Tables A6(1) & A6(5) in the Wiring Code.

### 7.8.2 Cable Sizing

The relationship among designed circuit current  $I_b$ , nominal rating of protective device  $I_n$  and effective current-carrying capacity of conductor  $I_z$  for an electrical circuit can be expressed as:

$$I_b \leq I_n \leq I_z$$

### 7.8.2.1 Conventional Method

Assumption: The supply voltages and load currents are sinusoidal and balanced among the three phases in a three-phase 4-wire power distribution system.

$$\text{Calculated minimum tabulated value of current: } I_{t(\min)} = I_n \times \frac{1}{C_a} \times \frac{1}{C_g} \times \frac{1}{C_i}$$

$$\text{Effective current-carrying capacity : } I_z = I_t \times C_a \times C_g \times C_i$$

Where  $I_t$  = the value of current tabulated in Appendix 6 of the Wiring Code

$C_a$  = Correction factor for ambient temperature

$C_g$  = Correction factor for grouping

$C_i$  = Correction factor for thermal insulation

### 7.8.2.2 Power Factor and Losses due to Harmonic Distortion in Circuits with Non-linear Loads

#### Displacement Power Factor (DPF) & Total Power Factor (TPF)

Consider a circuit with non-linear load current  $I$ , which is the r.m.s. value of fundamental  $I_1$  and all harmonic components  $I_2, I_3, I_4$ .

Assumption: The circuit is fed from a line voltage  $U$  having a low value of distortion and only the fundamental sinusoidal value  $U_1$  is significant:

$$\text{Apparent Power: } S = UI$$

$$\begin{aligned} S^2 &= (UI)^2 = U_1^2 (I_1^2 + I_2^2 + I_3^2 + I_4^2 + \dots) \\ &= U_1^2 I_1^2 \cos^2\theta + U_1^2 I_1^2 \sin^2\theta + U_1^2 (I_2^2 + I_3^2 + I_4^2 + \dots) \end{aligned}$$

According to this expression in the distorted circuit, the apparent power contains three major components:

(a) Active Power  $P$  in kW :  $P = U_1 I_1 \cos\theta$

(This is the effective useful power)

(b) Reactive Power  $Q_1$  in kVAR :  $Q_1 = U_1 I_1 \sin\theta$

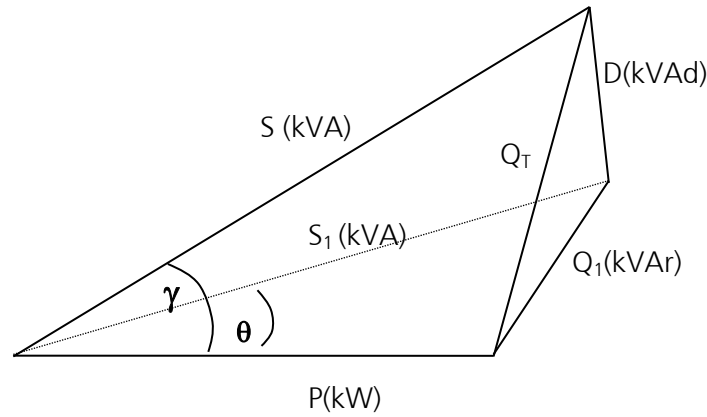
(This is the fluctuating power due to the fundamental component and coincides with the conventional concept of reactive power in an inductive circuit consumed and returned to the network during the creation of magnetic fields)

(c) Distortion Power  $D$  in kVAd  $D^2 = U_1^2 (I_2^2 + I_3^2 + I_4^2 + \dots)$

$D = U_1 \sqrt{(I_2^2 + I_3^2 + I_4^2 + \dots)}$  (This power appears only in distorted circuits and its physical meaning is that of a fluctuating power due to the presence of harmonic currents)

The relationship among these three power components can be shown in the following power triangles in TG Figure 7.8.2.2 :

**Figure 7.8.2.2 – Power triangles for apparent power, active power, reactive power & distortion power**



- (d) Fundamental Components :  $S_1^2 = P^2 + Q_1^2$   
with Displacement Power Factor (DPF)  $\cos\theta = P/S_1$
- (e) Fluctuating Power :  $Q_T^2 = Q_1^2 + D^2$
- (f) Power Triangle in Distorted Circuit :  $S^2 = Q_T^2 + P^2$   
with TPF  $\cos\gamma = P/S$  , which is always smaller than the DPF  $\cos\theta$ , and can be improved by either reducing the amount of harmonic distortion power (kVAd) or reactive power (kVAr)

The above expressions only give the approximate formulas neglecting any voltage distortion caused by voltage drop in line impedance. These harmonic voltages will give active and reactive components of power but the active power is generally wasted as heat dissipation in conductors and loads themselves.

### 7.8.3 Copper Loss Calculation

#### 7.8.3.1 For a Three-phase Balanced & Linear Circuit:

Apparent power transmitted along the circuit conductors in VA,  $S = \sqrt{3}U_L I_b$

Active power transmitted along the circuit conductors in W,  $P = \sqrt{3}U_L I_b \cos\theta$

Total copper losses in conductors in W,  $P_{\text{copper}} = 3 \times I_1^2 \times r \times L$

where  $U_L$  = Line to line voltage, 380V

$I_b = I_1$  = Design circuit current of the linear circuit in ampere (no distortion)

$\cos\theta$  = Power factor of the circuit

$r$  = a.c. resistance per metre at the conductor operating temperature

$L$  = Length of the cable in metre

Percentage copper loss with respect to the total active power transmitted,

$$\% \text{ loss} = \frac{3 \times I_1^2 \times r \times L}{\sqrt{3} U_L I_1 \cos\theta}$$

$$\text{Therefore, max. } r \text{ (m}\Omega\text{/m)} = \frac{\text{max. \% loss} \times U_L \times \cos\theta \times 1000}{\sqrt{3} \times I_1 \times L}$$

Appropriate conductor size can then be selected from TG Table 7.8 based on calculated value of r.

Correction for copper loss calculation due to various conductor operating temperature can be carried out as follows:

Conductor operating temperature at design current  $I_b$ , which =  $I_1$ , is given by:

$$t_1 = t_a + \frac{I_1^2}{I_t^2} (t_p - 30)$$

where  $t_a$  = actual or expected ambient temperature

$t_p$  = maximum permitted conductor operating temperature

ambient temperature = 30°C

The resistance of a copper conductor  $R_t$  at temperature  $t_1$  is given by:

$$R_t = R_{20} [1 + \alpha_{20} (t_1 - 20)]$$

where  $R_{20}$  = conductor resistance at 20°C

$\alpha_{20}$  = temperature coefficient of resistance of copper at 20°C  
(0.00393/°C)

or alternatively,

$$R_t = R_0 (1 + \alpha_0 t_1)$$

where  $R_0$  = conductor resistance at 0°C

$\alpha_0$  = temperature coefficient of resistance of copper at 0°C (0.00428/°C)

$$\text{Therefore ratio, } \frac{R_t}{R_p} = \frac{1 + \alpha_0 t_1}{1 + \alpha_0 t_p} \approx \frac{230 + t_1}{230 + t_p}$$

### 7.8.3.2 For a Three-phase Balanced Non-Linear Circuit Having Known Harmonic Current:

Apparent power transmitted along the circuit conductors in VA,

$$S = \sqrt{3} U_L I_b$$

$$\text{where } I_b = \sqrt{\sum_{h=1}^{\infty} I_h^2} = \sqrt{I_1^2 + I_2^2 + I_3^2 + \dots}$$

$$\text{From definition: THD} = \frac{\sqrt{\sum_{h=2}^{\infty} (I_h)^2}}{I_1}$$

$$\text{Therefore, } I_b = I_1 \sqrt{1 + \text{THD}^2}$$

$$\text{And, the fundamental current } I_1 = \frac{I_b}{\sqrt{1 + \text{THD}^2}}$$

Assuming voltage distortion is small,  $U_L = U_1$ , and active power transmitted along the circuit conductors in W is given by:

$$P = \sqrt{3} U_L I_1 \cos\theta$$

where  $U_L$  = Supply line voltage at 380V

$I_1$  = Fundamental phase current of the circuit in ampere

$\cos\theta$  = DPF

$$\text{And, TPF} = \frac{P}{S} = \frac{\cos\theta}{\sqrt{1 + \text{THD}^2}}$$

Assuming the skin and proximity effects are small, total copper losses in conductors including neutral in W is given by:

$$P_{\text{copper}} = (3 \times I_b^2 + I_N^2) \times r \times L$$

where  $I_N$  = Neutral current of the circuit in ampere

$$= 3 \times \sqrt{I_3^2 + I_6^2 + I_9^2 + \dots}$$

$I_b$  = Design r.m.s. phase current of the circuit in ampere

$r$  = a.c. resistance per metre at the conductor operating temperature

$L$  = Length of the cable in metre

Percentage copper loss with respect to the total active power transmitted,

$$\% \text{ loss} = \frac{(3 \times I_b^2 + I_N^2) \times r \times L}{\sqrt{3} U_L I_1 \cos\theta}$$

$$\text{Therefore, max. } r \text{ (m}\Omega\text{/m)} = \frac{\text{max. \% loss} \times \sqrt{3} \times U_L \times I_1 \times \cos\theta \times 1000}{(3 \times I_b^2 + I_N^2) \times L}$$

Appropriate conductor size can then be selected from TG Table 7.8 based on calculated value of  $r$ .

Correction for copper loss calculation due to various conductor operating temperature can be carried out as follows:

Conductor operating temperature at phase current  $I_b$  & neutral current  $I_N$  is given by:

$$t_1 = t_a + \frac{(3I_b + I_N)^2}{(3I_t)^2} (t_p - 30)$$

where  $t_a$  = actual or expected ambient temperature

$t_p$  = maximum permitted conductor operating temperature

The resistance of a copper conductor  $R_t$  at temperature  $t_1$  is given by:

$$R_t = R_0 (1 + \alpha_0 t_1)$$

where  $R_0$  = conductor resistance at 0°C

$\alpha_0$  = temperature coefficient of resistance of copper at 0°C  
(0.00428/°C)

Therefore ratio, 
$$\frac{R_t}{R_p} = \frac{1 + \alpha_0 t_1}{1 + \alpha_0 t_p} \approx \frac{230 + t_1}{230 + t_p}$$

#### 7.8.4 TPF & THD Inclusion in Copper Loss Calculation

For a circuit connected with a low power factor load and/or a non-linear load of influential scale, its TPF and THD of current should be included in the calculation of copper loss for cable sizing. Should a precise assessment at design not be feasible due to lack of information, the REA/designer should exercise due diligence by sizing the circuit based on the minimum allowable TPF and maximum allowable THD figures in BEC clause 7.6.1.1 & 7.6.2.2 respectively.

Having focused on the designed circuit current, the BEC does not establish the rules for part load operation. It is assumed that during part load, the TPF and the THD, which may be respectively lower for TPF and higher for THD than the corresponding figures in BEC clause 7.6.1.1 & 7.6.2.2, the magnitude of the current and power is usually lower than at full load and thus has a lower impact.

#### 7.9 Illustrative Example on Calculation of Copper Loss

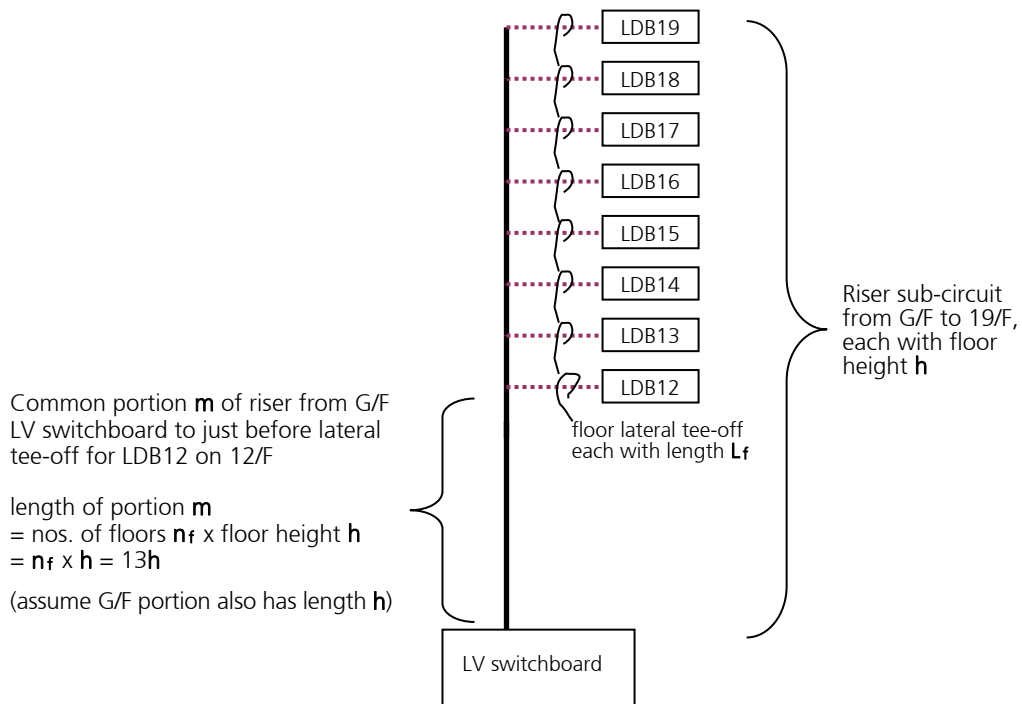
The following gives an illustration of copper loss calculation based on the approach indicated in TG clause 7.8. Consider for a non-residential building a sub-circuit in the form of a riser feeding local distribution boards (LDB) namely LDB12 to LDB19 on 8 nos. floors namely 12/F to 19/F, one LDB for each floor, each of the floor lateral tee-offs having the same length. For illustration simplicity, it is assumed that –

- each of the floor LDB demands at full load a fundamental current  $I_1$  of 45A 3-phase,
- a diversity factor **df** of 0.85 is to be applied to the floor loads to arrive at the load of the sub-circuit (**df** is described in TG Table 7.4(b)iii),
- the ambient condition  $t_a$  is 30°C,

- multicore PVC/SWA/PVC copper cable with max conductor operating temperature of 70°C is used, with mounting on perforated cable tray,
- all correction factors  $C_a$ ,  $C_p$ ,  $C_g$  &  $C_i$  (described in TG clause 7.8.2.1 and the Wiring Code) are all at unity,
- the skin effect and proximity effect of any harmonic currents are negligible, and harmonic distortion of voltage is neglected, and
- information on the power factor and harmonic contents of the loads in the lateral circuits are not available, which means that they have to be estimated based on the approach described in TG clause 7.8.4. A schematic of the sub-circuit is given in TG Figure 7.9.1 below.

Determine the cable sizes of the riser and the lateral tee-offs.

**Figure 7.9.1 : Schematic of sub-circuit for illustration of design considerations, cable selection, and copper loss calculations**



The design considerations, the cable selection, and the copper loss calculations are illustrated respectively in TG Tables 7.9.1(a) to (c).

<b>Table 7.9.1 (a) : Illustration of Conductor Design Considerations</b>				
DESIGN CONSIDERATIONS	<u>Abbrev.</u>	<u>Equation described in TG clause 7.8.3 / Relevant TG paragraphs</u>	<u>Floor tee-off</u>	<u>Riser</u>
Floor height (metre)	<b>h</b>	Not applicable (NA)	NA	3
Nos. of floors from G/F to floor of first lateral tee-off	<b>n<sub>f</sub></b>		NA	13
Length of floor lateral tee-off (metre)	<b>L<sub>f</sub></b>		10	NA
Nos. of tee-offs, one per floor, for all the eight floors from 12/F to 19/F	<b>n<sub>t</sub></b>		NA	8
Conductor ambient temperature (°C)	<b>t<sub>a</sub></b>	TG clause 7.8.3	30	
Allowable copper loss (%)	<b>%loss</b>	TG Table 7.4 (b) ii)	1.5%	
Diversity factor	<b>df</b>	TG Table 7.4(b) iii)	NA	0.85
Fundamental current (A)	<b>I<sub>1</sub></b>	TG clause 7.8.3	45	306
Total harmonic distortion (%)	<b>THD</b>	$THD = \frac{\sqrt{\sum_{h=2}^{\infty} (I_h)^2}}{I_1}$ TG clauses 7.8.3 & 7.8.4	15%	NA
Neutral current	<b>I<sub>N</sub></b>	$I_N = 3 \times \sqrt{I_3^2 + I_6^2 + I_9^2 + \dots}$ TG clause 7.8.3	0	0
Design root mean square phase current (A)	<b>I<sub>b</sub></b>	$I_b = I_1 \times \sqrt{(1+THD^2)}$	45.5	309.4
Protective device rating (A)	<b>I<sub>n</sub></b>	$I_b \leq I_n$	55	320
Total power factor	<b>TPF</b>	TG clauses 7.8.3 & 7.8.4	0.85	NA
Displacement power factor	<b>DPF</b> cosθ	$\cos\theta = TPF \times \sqrt{(1+THD^2)}$	0.86	NA
Effective length of whole sub-circuit (metre) (for purpose of quick estimation of <b>Max r</b> only, equation alongside does not appear in TG clause 7.8.3)	<b>EL</b>	$EL = h \times (n_f + 7/8 + 6/8 + 5/8 + 4/8 + 3/8 + 2/8 + 1/8) + L_f$	59.5	
Max resistance (mΩ per metre) of conductor	<b>Max r</b>	$\frac{\%loss \times \sqrt{3} \times 380 \times I_1 \times \cos\theta \times 1000}{(3 \times I_b^2 + I_N^2) \times L}$	1.0332	0.1519
<p><b>Remark to <u>Max r</u></b></p> <p>The <b>Max r</b> value is for purpose of quick estimation of conductor resistance in selecting the cable size. The <b>r</b> values in cable selection and copper loss calculations in TG Tables 7.9.1(b) &amp; 7.9.1(c) below are the values in TG Table 7.8 or the Wiring Code and not the <b>Max r</b> value. For the lateral tee-off, the <b>%loss</b> value in calculating <b>Max r</b> is not 1.5% but adjusted by a ratio of <b>L<sub>f</sub>/EL</b> or 0.168 to better represent the lateral tee-off's apportionment.</p> <p><b>Remark to <u>I<sub>N</sub></u></b> (neutral current)</p> <p>For simplicity it is assumed the neutral current is negligible. Nevertheless the equations of <b>Max r</b> (above), <b>t<sub>1</sub></b> (TG Table 7.9.1(b) ) and <b>P<sub>copper</sub></b> (TG Table 7.9.1(c) ) account for the inclusion of <b>I<sub>N</sub></b> in the calculation, which may not be negligible in case of triplen harmonics or unbalanced distortion.</p>				



<b>Table 7.9.1 (b) : Illustration of Cable Selection (4/C PVC/SWA)</b>				
<b>CABLE SELECTION</b>	<b>Abbrev.</b>	<u>Equation described in TG clause 7.8.3 / Relevant TG paragraphs</u>	<b># Tee-off</b> <b>16 mm<sup>2</sup></b>	<b>Riser</b> <b>150 mm<sup>2</sup></b>
Conductor resistance (mΩ per metre)	<b>r</b>	TG Table 7.8 and Wiring Code	1.4	0.15
Permitted conductor temperature (°C)	<b>t<sub>p</sub></b>	TG clause 7.8.3 and Wiring Code	70	70
Conductor tabulated current carrying capacity (A)	<b>I<sub>t</sub></b>		83	332
Conductor operating temperature (°C) at <b>I<sub>b</sub></b>	<b>t<sub>1</sub></b>	$t_1 = t_a + \frac{(3I_b + I_N)^2}{(3I_t)^2} (t_p - 30)$	42.02	64.74
Ratio of conductor resistance at <b>t<sub>1</sub></b> to <b>t<sub>p</sub></b>	<b>R<sub>t</sub>/R<sub>p</sub></b>	$\frac{R_t}{R_p} \approx \frac{230 + t_1}{230 + t_p}$	0.907	0.982
<p><u>Remark# to 16 mm<sup>2</sup> cable selection</u></p> <p>A cable of smaller size having a <b>r</b> value greater than <b>Max r</b> is selected as a trial, as the actual current with the application of diversity factor <b>df</b> would be lower than <b>I<sub>b</sub></b>; the cable can be upgraded if needed based on actual <b>P<sub>copper</sub></b> calculated in TG Table 7.9.1(c). (Later calculations in TG Table 7.9.1(c) justify the trial selection of 16mm<sup>2</sup>.)</p>				

Table 7.9.1 (c) : Illustration of Copper Loss Calculations								
COPPER LOSS CALCULATIONS	Current $I_b$ ( $df$ applied) (A)	Resistance $r$ ( $R_r/R_p$ applied) at $t_1$ ( $m\Omega$ per metre)	Length L (metre)		Copper loss $P_{copper}$ (Watt)		Sub-circuit active power P (Watt)	
			$n_f \times h$					
common portion m (G/F to 12/F of 13 floors)	309.4	0.147	$n_f \times h$	39	$\{ [3 \times I_b^2 (df applied) + I_N^2] \times r \times L \} / 1000$	1650.9	$\sqrt{3} \times 380 \times I_{m1} \times \cos\theta$	173,108
12/F lateral tee-off	38.7	1.269	$L_f$	10		57.0		
13/F riser portion	270.7	0.147	$h$	3		97.2		
13/F lateral tee-off	38.7	1.269	$L_f$	10		57.0		
14/F riser portion	232.1	0.147	$h$	3		71.4		
14/F lateral tee-off	38.7	1.269	$L_f$	10		57.0		
15/F riser portion	193.4	0.147	$h$	3		49.6		
15/F lateral tee-off	38.7	1.269	$L_f$	10		57.0		
16/F riser portion	154.7	0.147	$h$	3		31.7		
16/F lateral tee-off	38.7	1.269	$L_f$	10		57.0		
17/F riser portion	116.0	0.147	$h$	3		17.9		
17/F lateral tee-off	38.7	1.269	$L_f$	10		57.0		
18/F riser portion	77.4	0.147	$h$	3		7.9		
18/F lateral tee-off	38.7	1.269	$L_f$	10		57.0		
19/F riser portion	38.7	0.147	$h$	3		2.0		
19/F lateral tee-off	38.7	1.269	$L_f$	10		57.0		
Total						2,384		
<b>% Copper Loss = 1.38%</b>								

In conclusion for the sub-circuit, 150 mm<sup>2</sup> cable is to be adopted for the riser and 16 mm<sup>2</sup> cable for the floor lateral tee-off, achieving a percent copper loss of 1.38% (TG Table 7.9.1 (c)), meeting the 1.5% requirement.

## 8. Energy Efficiency Requirements for Lift and Escalator Installation

### 8.1 Scope of Application (BEC clause 8.1)

#### 8.1.1 Comprehensive View on Applicability (BEC clause 8.1.1)

BEC Section 8 provides the guidelines for lift and escalator installations. To gain a comprehensive view in relation to the Ordinance, BEC clause 8.1 should be read in conjunction with –

- BEC Sections 3 & 4 that briefly describe the scope and limits of the application of the Ordinance based on its prescribed requirements in Parts 2 & 3; and
- TG Sections 3 & 4 that elaborate on the scope and limits of application and the necessary steps to demonstrate the compliance with the Ordinance and the BEC.

For reference, the interpretation of ‘lift and escalator installation’ under the Ordinance and the BEC is extracted below -

‘lift and escalator installation’ has the same meaning in the Ordinance, which means a system of equipment comprising –

- (a) a lift or escalator as defined in section 2(1) of the Lifts and Escalators (Safety) Ordinance (Cap 618); and
- (b) any associated installation specified in a code of practice that is used for the operation of the lift or escalator;

#### 8.1.2 Examples of BEC Applicable Installations (BEC clause 8.1.2)

In respect of certain types of lift and escalator installations, BEC clause 8.1.2 affirms for the avoidance of doubt the Ordinance’s applicability to these installations, and examples thereof are given in TG Table 8.1.2 below.

<b>Table 8.1.2 : Examples of BEC Applicable Lift and Escalator Installations</b>	
<u>Examples</u>	<u>Justifications</u>
Bed passenger lift in a hospital	BEC clause 8.1.2 (a)
Freight lift serving common lift lobbies in an industrial building	
Vehicle lift carrying vehicles	
Double Deck Lift <sup>(#)</sup>	
Observation lift at the building facade	BEC clause 8.1.2 (c)
Escalator (owned by the building owner) at the building facade	

(# Remarks: Having not specified otherwise in respect of non-applicability, BEC Section 8 should also be applicable to a double-deck lift having two attached cars one on top of the other.)

8.1.3 Examples of BEC Non-applicable Installations (BEC clause 8.1.3)

BEC clause 8.1.3 lists certain lift and escalator installations to which the Ordinance does not apply, and examples of these installations are given in TG Table 8.1.3 below.

<b><u>Table 8.1.3 : Examples of BEC Non-applicable Lift and Escalator Installations</u></b>	
<u>Examples</u>	<u>Justifications</u>
Mechanized vehicle parking system in a car park	BEC clause 8.1.3 (a) (A mechanized vehicle parking as defined in Cap 618 is a mechanical plant that has a power operated mechanism for conveying a vehicle to a parking space within the plant.)
Service lift for transporting food in a restaurant	BEC clause 8.1.3 (b) (A service lift as defined in Cap 618 is a lift having a rated load of not more than 250 kg and restricted physical dimensions, and is not meant for the transporting of persons.)
Stairlift at a stairway	BEC clause 8.1.3 (c) (A stairlift as interpreted in BEC Section 2 is specifically for transporting an ambulant disabled person or person in a wheelchair.)
Industrial truck load freight lift in an industrial building, (for loading and unloading by an industrial truck)	BEC clause 8.1.3 (d) (An industrial truck load freight lift as interpreted in BEC Section 2 can cater for uneven distributed over the lift floor, and the weight of any single piece of freight and its truck can exceed a quarter of the rated load of the lift.)
Lift at the backstage of performing arts centre / stadium	BEC clause 8.1.3 (e) (A lift in a performance stage as interpreted in BEC Section 2 is designated to serve the performers of a show on stage.)
Lifting platform usually serving a wheelchair, for use by persons with physical disability	BEC clause 8.1.3 (f) (A powered lifting platform not having a lift car; interpretation of powered lifting platform is also given in BEC Section 2.)
Scissor lift	

Rack and pinion lift	BEC clause 8.1.3 (g) (A rack and pinion lift is a lift not operated on traction drive by suspension ropes or not operated by hydraulic piston, but operated on a system of rack and pinion.)
Temporary construction hoist lift at construction site	BEC clause 8.1.3 (h); as prescribed in item 3, Schedule 2 of the Ordinance, the Ordinance does not apply to installation solely used in a construction site for construction works only.

## 8.2 General Approach (BEC clause 8.2)

The energy efficiency requirements in BEC clauses 8.4 to 8.7 are based on the general approach to energy efficiency given in BEC clause 8.2.

## 8.3 Definitions (BEC clause 8.3)

BEC Section 2 provides the interpretations and abbreviations related to the BEC and the Ordinance, including those for lift and escalator installation.

## 8.4 Electrical Power (BEC clause 8.4)

### 8.4.1 Traction Drive Lift (BEC clause 8.4.1)

#### 8.4.1.1 Maximum Allowable Electrical Power (BEC clause 8.4.1.1 and BEC Table 8.4.1a & b)

In respect of the running active electrical power of the motor drive of a traction drive lift when carrying rated load and travelling upward at rated speed, BEC clause 8.4.1 specifies in BEC Table 8.4.1a & BEC Table 8.4.1b for its maximum allowable value across a range of rated loads and rated speeds for new building and existing building respectively. The meanings of rated load and rated speed are defined in Cap 618. The motor drive by its interpretation in BEC Section 2 means the motor plus its driving controller. Information on running active electrical power, which includes the electrical losses of the driving controller, can be obtained from lift suppliers, and be verified from actual site testing. The imposing of the requirement can minimize the electrical losses in the driving controller, minimize the frictional losses in the mechanical power transmission and discourage the oversizing of lift motors.

As an example illustrating the requirement in BEC Table 8.4.1a, it can be read off from the table that the maximum allowable electrical power of a lift with rated load at 1,200 kg and 1.75 m/s rated speed, which installed in a newly constructed building, is 17.4 kW. For the case of major retrofitting works in respect of a lift installation of the same duty, the maximum allowable electrical power is 17.9 kW as read off from BEC Table 8.4.1b.

#### 8.4.1.2 Exemption from Maximum Allowable Electrical Power (BEC clause 8.4.1.2)

(a) The exemption from the maximum allowable electrical power requirement is given in BEC clause 8.4.1.2 (a) to a traction lift fulfilling all the conditions below –

- having rated speed not less than 9 m/s,
- serving a zone distance of over 50-storey or over 175m,
- above zone distance counted between the top-most or bottom-most landing and the principal or ground landing, and
- it can serve as a fireman's lift, or it is a sky lobby shuttle serving two principal stops (such as ground landing and sky lobby landing, sky lobby amidst the top floors).

(b) The exemption from the maximum allowable electrical power requirement is also given in BEC clause 8.4.1.2 (b) to a traction lift with rated load at or above 5,000 kg and at rated speed of 3 m/s or above. Examples of a lift so exempted would be a large passenger lift for over 60 passengers, or a heavy duty vehicle lift or freight lift.

#### 8.4.2 Hydraulic Lift (BEC clause 8.4.2 and BEC Table 8.4.2)

##### 8.4.2.1 Maximum Allowable Electrical Power (BEC clause 8.4.2 and BEC Table 8.4.2)

In respect of the running active electrical power of the motor of the oil pump of a hydraulic lift when carrying rated load and travelling upward at rated speed, BEC clause 8.4.2 specifies in BEC Table 8.4.2 its maximum allowable value across a range of rated loads. The meanings of rated load and rated speed are defined in Cap 618. Information on running active electrical power can be obtained from lift suppliers, and be verified from actual site testing. The imposing of the requirement can minimize the frictional losses in the power transmission and discourage the oversizing of oil pump and pump motor. The requirement is irrespective of whether the hydraulic mechanism is direct acting on the bottom of the lift car, acting on the side of the lift car, or indirect acting through suspension means.

#### 8.4.3 Escalator (BEC clause 8.4.3 and BEC Table 8.4.3)

In respect of the running active electrical power of the steps driving motor of the escalator when carrying no-load and travelling at rated speed, BEC clause 8.4.3 specifies in BEC Table 8.4.3 its maximum allowable value. BEC Table 8.4.3 gives the maximum allowable values across a range of escalator nominal widths, rises and speeds, for the non-public service escalator, the public service escalator and the heavy duty escalator. The meaning of rated speed is defined in Cap 618, and the meanings of nominal width and rise refer to the same meanings so conveyed in the Code of Practice on the Design and Construction of Lifts and Escalators issued by EMSD. The meaning of public service escalator is given in BEC Section 2, which refers to one that forms part of a public traffic system such as connecting a building to a traffic station or

public transport interchange. The heavy duty escalator with its characteristics given in BEC Table 8.4.3 refers to one for heavy duty and demand in a railway station. Information on running active electrical power can be obtained from escalator suppliers, and can be verified from actual site testing. Based on the heavier demand and duty of the passenger load, the public service escalator is accorded a higher allowable electrical power than the non-public service escalator, and likewise the heavy duty escalator is accorded a higher allowable electrical power than the public service escalator. In the case of a multi-speed energy efficient escalator, the maximum allowable electrical power applies to the power consumption at the highest speed.

#### 8.4.4 Passenger Conveyor (BEC clause 8.4.4 and BEC Table 8.4.4)

In respect of the running active electrical power of the steps driving motor of the passenger conveyor when carrying no-load and travelling at rated speed, BEC clause 8.4.4 specifies in BEC Table 8.4.4 its maximum allowable value. BEC Table 8.4.4 gives the maximum allowable values across a range of conveyor nominal widths, lengths, and speeds, for the non-public service passenger conveyor, and the public service passenger conveyor. The meaning of rated speed is defined in Cap 618, and the meanings of nominal width and length refer to the same meanings so conveyed in the Code of Practice on the Design and Construction of Lifts and Escalators issued by EMSD. The meaning of public service passenger conveyor is given in BEC Section 2, which refers to one that forms part of a public traffic system such as connecting a building to a traffic station or public transport interchange. Information on running active electrical power can be obtained from passenger conveyor suppliers, and can be verified from actual site testing. In the case of a multi-speed energy efficient passenger conveyor, the maximum allowable electrical power applies to the power consumption at the highest speed.

The maximum allowable running active electrical power requirement applies to passenger conveyors at inclinations up to 6° from horizontal, and does not apply to ones at higher inclination.

BEC Table 8.4.4 gives the maximum allowable electrical power for passenger conveyors with nominal widths at 800mm, 1,000mm and 1,400mm and above. There are passenger conveyors between 1,000 and 1,400mm, and their allowable values can be obtained by interpolating the control values for 1,000mm and 1,400mm. Take for example a non-public service passenger conveyor at 1,200mm width with length 10m and at 0.5 m/s rated speed. From BEC Table 8.4.4, the allowable value for 1,000mm is 2,514W and that for 1,400mm is 3,142W. By interpolating the two values, the allowable value for 1,200mm is  $(2,514 + 3,142) \div 2 = 2,828W$ .

8.5 Utilization of Power (BEC clause 8.5)

8.5.1 Total Power Factor (BEC clause 8.5.1)

(a) General Requirements

The requirements on total power factor (TPF) given in BEC clause 8.5.1 is summarized in TG Table 8.5.1(a) below.

<b>Table 8.5.1 (a) : Requirements on Total Power Factor</b>		
<u>Equipment</u>	<u>Operating condition</u>	<u>Requirements</u> (BEC clauses 8.5.1.1 to 8.5.1.3)
Lift	When carrying rated load at rated speed and travelling upward	The TPF of the motor drive circuit (at the isolator connecting to the building's electrical supply circuit) should not be less than 0.85. (motor drive means motor plus driving controller)
Escalator Passenger Conveyor	When operating under brake load at rated speed and for equipment with a rise with steps or pallets moving upward	The TPF of the motor drive circuit at either <ul style="list-style-type: none"> <li>a. the isolator connecting the escalator or passenger conveyor to the building's electrical supply circuit; or</li> <li>b. the circuit protective device serving the escalator or the passenger conveyor</li> </ul> should not be less than 0.85. (motor drive means motor plus driving controller)
Remarks: (a) A correction device if needed can be installed at the motor control centre of the motor drive to improve the TPF to 0.85 (BEC clause 8.5.1.3). (b) If the manufacturer-provided driving controller when coupled with the motor meets the TPF requirement, the installation of a correction device is not required.		

TPF accounts for the combined effect of the displacement power factor (DPF) of the motor (of the driven equipment, i.e. the lift, escalator or passenger conveyor) and the THD of the driving controller, and as such the DPF is greater in value than the TPF (TPF and THD are also described in TG clauses 7.6 and 7.8). The DPF of a properly sized induction motor delivering at the operating condition (in TG Table 8.5.1(a)) the output power to the driven equipment is usually quite close to its value at full (motor) load. The equipment supplier should assess the TPF based on the THD of the driving controller and the DPF of the equipment motor. For lifts the TPF can be verified based on actual measurement at rated load rated speed upward, whereas for escalator and passenger conveyor given practical site difficulty in providing the brake load condition, it may be necessary to rely more on the assessment, an approach of which is given in TG clause 8.5.1(b) below.



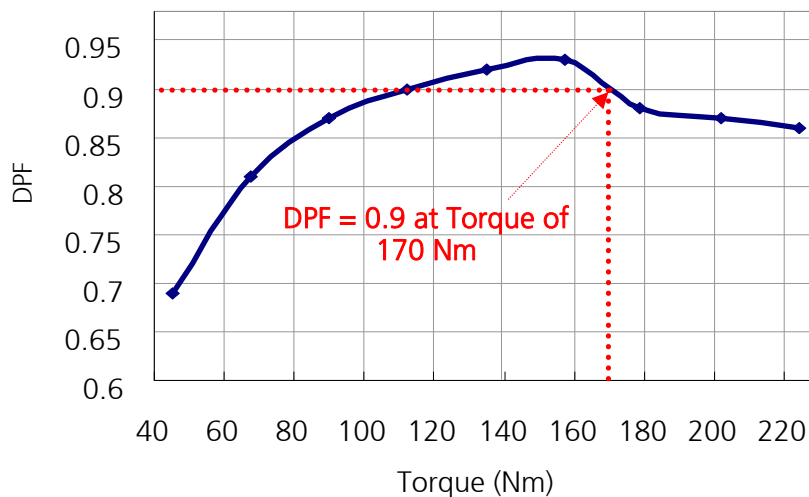
(b) Motor DPF for Assessment of TPF for Escalator and Passenger Conveyor

The applicable DPF of the motor, when driving a load equivalent to the brake load of the escalator or passenger conveyor, can usually be identified from the motor data sheet that records the testing parameters of the motor, which is usually available from the motor manufacturer and typically gives a range of values of DPF and load or torque (Newton-metre). (The data sheet usually gives, alongside the load values, also the values of RPM, running current, input power, output power, efficiency, % slip, voltage etc.) The brake load of an escalator or passenger conveyor is usually known at the design stage, and by identifying this brake load value against the range of values of motor torque in the motor data sheet the corresponding DPF can be identified.

Take for example an escalator having a brake load of 170 Newton-metre (Nm), which is the torque load demanded on its driving motor. An extract of the motor torque and DPF values from the motor data sheet is as follows -

<b>Torque (Nm)</b>	45.0	67.4	89.9	112.4	134.9	157.4	178.9	201.9	224.1
<b>DPF</b>	0.69	0.81	0.87	0.90	0.92	0.93	0.88	0.87	0.86

**Figure 8.5.1 (b) : DPF versus torque of motor driving escalator**



A curve of DPF against torque is compiled in TG Figure 8.5.1 (b) from which it can be observed that at a torque of 170 Nm the corresponding DPF is 0.9.

Based on this identified DPF, the escalator supplier can after accounting for the THD of the driving controller (at the same brake load) assess the TPF of the motor drive assembly.

The above approach should work well for an equipment operating on mains sinusoidal voltage at its brake load. For an equipment operating on inverter (driving controller) supplied voltage that may not be purely sinusoidal, the inverter

output voltage, subject to no oversizing of motor, may be set at close to mains voltage during the brake load. The BEC maximum allowable electrical power requirement (TG clauses 8.4.3 & 8.4.4) serves to discourage motor oversizing.

### 8.5.2 Lift Decoration Load (BEC clause 8.5.2)

The interpretation of decoration load in BEC Section 2 is extracted below for ready reference.

‘lift decoration load’ means the loads of the materials used in a lift car for decorative purpose and not essential to lift operative functions delineated in the Code of Practice on the Design and Construction of Lifts and Escalators, EMSD, which should include the floor tiles, additional ceiling panels, additional car wall decorative panels and their corresponding materials for backing and/or fixing, but however exclude the balancing weights in association with provision of air-conditioning to the lift car.

The decoration load is a “dead load” that consumes power in counteracting its weight irrespective of whether the travelling lift is carrying passengers/goods or not. The maximum allowable decoration load is specified in BEC Table 8.5.2. TG Table 8.5.2 below gives the calculated values of decoration load based on the equations in BEC Table 8.5.2.

<b>Table 8.5.2 : Allowable Lift Decoration Load</b> (based on BEC Table 8.5.2)									
<u>Lift Rated Load</u> (kg)	500	600	700	800	900	1000	1100	1200	1300
<u>Allowable Decoration Load</u> (kg)	202.5	243	283.5	324	364.5	405	445	445	445
<u>Lift Rated Load</u> (kg)	1400	1500	1600	1700	1800	1900	2000	2100	2200
<u>Allowable Decoration Load</u> (kg)	445	445	445	445	445	466.6	487.8	508.7	529.3
<u>Lift Rated Load</u> (kg)	2300	2400	2500	3000	3500	4000	4500	5000	-
<u>Allowable Decoration Load</u> (kg)	549.5	569.4	588.9	681.8	766.2	842.4	910.2	915	-

As opposed to the adoption of traditional heavy stone panel as the interior floor and side wall of the lift car, other lighter alternatives such as slightly thinner stone panel, light-weight stone panel (with aluminum backing) or vinyl tiling (for floor) may be considered to reduce the weight of this “dead load”. For the wall in particular, which demands a lower durability when compared with the floor, the light-weight stone panel or a lower percentage of tiled wall are good alternatives. The REA/designer should convey the requirement of decoration load to the architect or building owner well before the finalization of the architectural design of the lift car. The REA/designer may ask the architect or building owner to provide the car interior’s layout, installation details, and material specification as a substantiation of meeting the decoration load

requirement. Calculations and the substantiation materials should be submitted as compliance demonstration.

#### 8.5.3 Lift Parking Mode (BEC clause 8.5.3)

BEC clause 8.5.3 requires that at least one lift of a lift bank during low traffic period should be operable at parking mode. A lift bank as interpreted in BEC Section 2 means a lift system with two or more lifts serving a zone, including lifts that may serve more than one zone but for the time in question serving only the specific zone. With the lift idled at parking mode, its ventilation or air-conditioning can be shut off and its driving controller's electronics may enter into an energy saving mode.

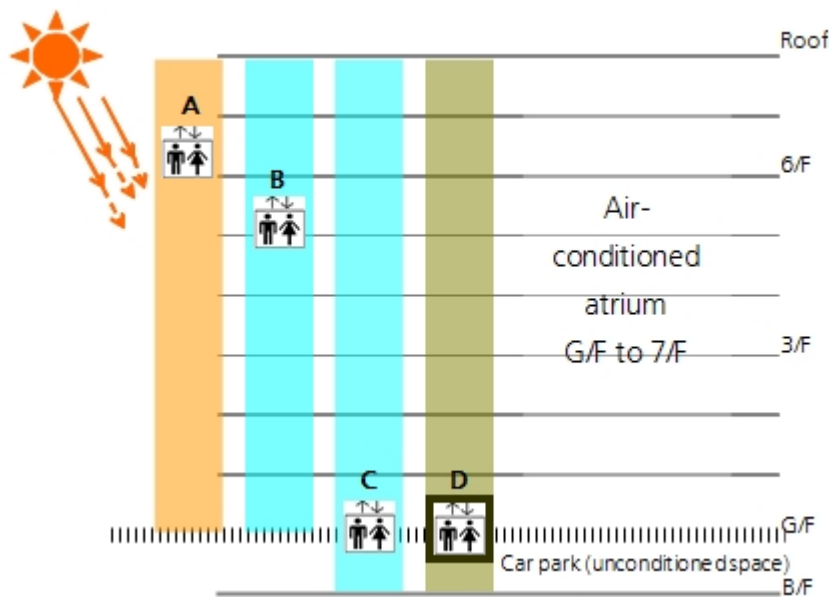
The parking mode may be actuated by lift auto programming, or by manual switching at the lift supervisory panel or at the control switch in the lift lobby or building management counter. The parking mode may be discontinued when the low traffic period ends. With auto programming, the starting or ending of low traffic period may be set based on the time of the day or the number of landing and/or car calls. With manual switching, the setting to parking mode may be based on the time of the day (e.g. midnight hours). A low traffic period may be identified by the traffic demand on the lift bank falling to below a certain level, say 20%, of the lift bank's handling capacity, which is the total number of passengers the lift bank can transport within a representative period of time (such as 5 minutes) at the peak traffic period; in simple terms (for reference by frontline building operators), a low traffic period may be identified by the passengers incoming rate falling to below say 20% of that at the peak time.

#### 8.5.4 Lift Ventilation & Air-conditioning (BEC clause 8.5.4)

Aiming at provision only on a need basis, BEC clause 8.5.4.1 specifies that the ventilation or air-conditioning in a lift after having idled for a specific period should be automatically shut off, until the lift is reactivated.

To maintain thermal comfort in lift cars exposed to solar heat gain or infiltration from the surrounding unconditioned space, an observation lift under such exposure are exempted from the requirement in BEC clause 8.5.4. The observation lift refers to a lift with see-through glazed car wall/door and within a usually glazed or partially glazed lift well. The exemption is illustrated in TG Figure 8.5.4 using four lifts serving an air-conditioned atrium, three being observation lifts A, B & C with see-through glazing walls and the remaining an ordinary lift D. Lifts C and D serve both the car park at B/F (un-conditioned space) and the atrium, and lift A (at the building façade and exposed to atmosphere) and lift B (well within the air-conditioned atrium) serve only the atrium.

**Figure 8.5.4 : Exemption from automatic shut-off of lift ventilation and air-conditioning at idling**



<u>Lift designation</u>	<u>Exemption from Automatic Shut-off</u>	<u>Justifications / Remarks</u>
Observation lift A (with glazed car wall)	Yes	Travelling through outdoor space
Observation lift B (with glazed car wall)	No	Not travelling through outdoor or unconditioned space
Observation lift C (with glazed car wall)	Yes	Travelling through un-conditioned space, the carpark
Ordinary lift D (without glazed car wall)	No	Not an observation lift

The triggering condition of the shut-off for ventilation and for air-conditioning are different, for ventilation it is after the lift having idled 2 minutes whereas for air-conditioning it is after 10 minutes and accompanied with a further requirement of air-conditioning resumption no earlier than 5 minutes after the shut-off. Serving to delay the stopping and starting of the compressor of the lift's unitary air-conditioner, the 10-minute delay to shut-off and 5-minute delay to restart are to strike a balance between the maintaining of air-conditioning thermal comfort, the saving of air-conditioning energy (when lift is idled), and the sustaining of the compressor's operating life which would much shorten if stopped and started too frequently.

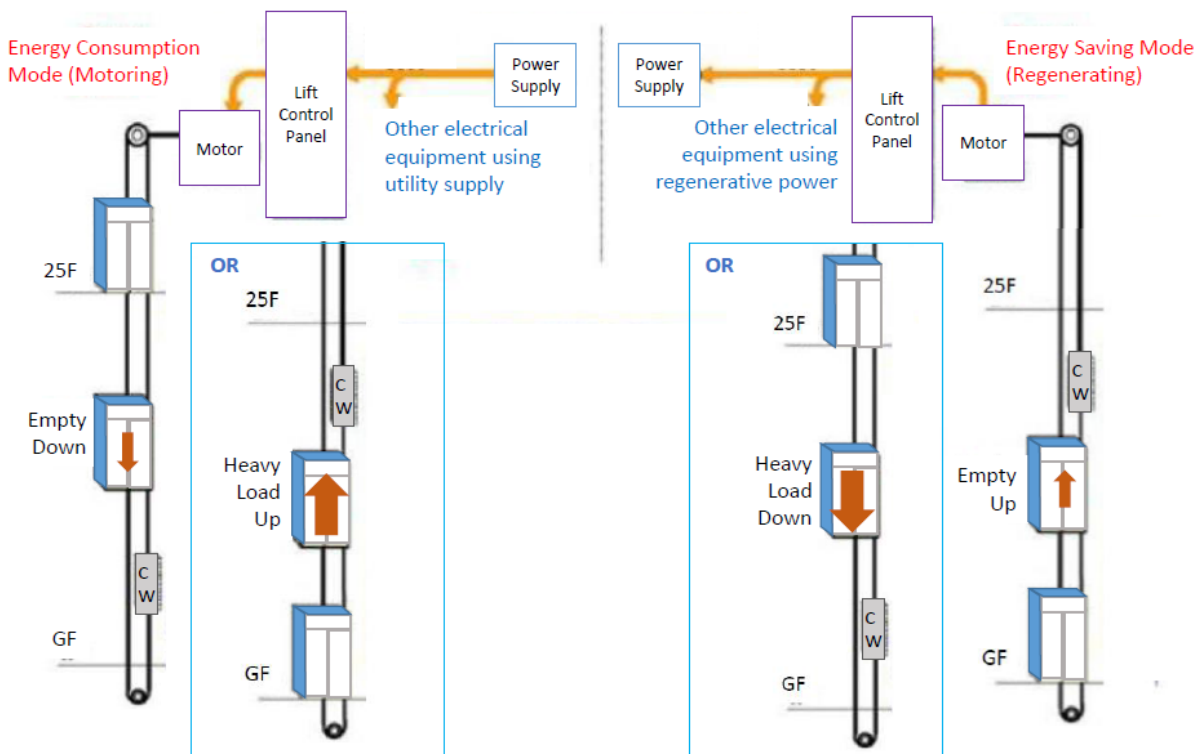
The energy performance of the lift car ventilation fan is specified under BEC clause

8.5.4.3 that it should consume at or below 0.7 W per unit design airflow in L/s.

8.5.5 Lift Regenerative Braking

For lifts with regenerative function, its traction machine acts as a power generator and regenerates power when it travels downwards with full load or upwards with empty car. Figure 8.5.5 (a) illustrates a lift with regenerative function under motoring / regenerative mode. Regenerative braking function can be obtained from the regenerative braking module installed with the variable voltage variable frequency (VVVF) drives performing energy reclaim. The amount of regenerative power obtained depends on the lift operating speed, travel distances, and the operation pattern. BEC mandates feeding the regenerative power to the incoming power supply source. Dissipating the energy through resistor bank is not permissible.

**Figure 8.5.5 (a): Example of lift with regenerative function**



8.5.6 Lift Car Automatic Lighting Control

BEC clause 8.5.6 specifies the requirement on automatic lighting control in lift car. In fulfilling the requirement, the lighting should be switched off or dimmed down to 50% or less automatically when the lift idles for 10 minutes. Subject to the type of control system adopted, for example, when the lift has idled for 10 minutes, a signal from the lift control panel should be sent to the contactor relay of lift car lighting for switching off the light or an analogue signal for light dimming.

The requirement of lighting control point under BEC clause 5.5.1 and exception under clause 5.6.1.1 are not applicable to the lighting installation of lift car. Automatic lighting control must be provided for lighting installation of lift car regardless of total power consumption of the lighting installation.

#### 8.5.7 Automatic Speed Reduction of Escalator (BEC clause 8.5.7)

In fulfilling the requirement, each of the escalator should be equipped with a switching device in such a way that the operator (or the owner of the escalator) may set the escalator under the automatic speed reduction mode during the low traffic demand period. The speed is lowered when no passenger is detected for a pre-set period of time while the escalator resume normal speed once it detects approaching passenger. Automatic stop should be implemented with great care not to confuse the approaching passenger that the stopped escalator is out of service. TG Figure 8.5.7 (a) and (b) show examples of pole mounted and floor mounted sensors for escalator speed control respectively.

**Figure 8.5.7 (a): Example of pole mounted sensors**



**Figure 8.5.7 (b): Example of floor mounted sensors**



8.6 Total Harmonic Distortion (BEC clause 8.6)

The requirements on total harmonic distortion (THD) given in BEC clause 8.6 is summarized in TG Table 8.6.1 below.

<b>Table 8.6.1 : Requirements on Total Harmonic Distortion</b>														
<u>Equipment</u>	<u>Operating condition</u>	<u>Requirements (BEC clauses 8.6.1 to 8.6.3)</u>												
		The THD in each phase produced by the motor drive at the isolator connecting the lift, escalator or passenger conveyor to the building’s electrical supply circuit should be limited to the following (BEC Tables 8.6.1 & 8.6.2) -												
Lift	Carrying rated load at rated speed and travelling upward	<table border="1"> <thead> <tr> <th><u>Circuit fundamental current I</u></th> <th><u>THD (%) in each phase</u></th> </tr> </thead> <tbody> <tr> <td><math>I &lt; 40A</math></td> <td>40%</td> </tr> <tr> <td><math>40A \leq I &lt; 80A</math></td> <td>35%</td> </tr> <tr> <td><math>80A \leq I &lt; 400A</math></td> <td>22.5%</td> </tr> <tr> <td><math>400A \leq I &lt; 800A</math></td> <td>15%</td> </tr> </tbody> </table>	<u>Circuit fundamental current I</u>	<u>THD (%) in each phase</u>	$I < 40A$	40%	$40A \leq I < 80A$	35%	$80A \leq I < 400A$	22.5%	$400A \leq I < 800A$	15%		
		<u>Circuit fundamental current I</u>	<u>THD (%) in each phase</u>											
		$I < 40A$	40%											
		$40A \leq I < 80A$	35%											
		$80A \leq I < 400A$	22.5%											
$400A \leq I < 800A$	15%													
Escalator  Passenger Conveyor	Carrying no load at rated speed	<table border="1"> <thead> <tr> <th><u>Circuit fundamental current I</u></th> <th colspan="2"><u>THD (%) in each phase</u></th> </tr> </thead> <tbody> <tr> <td><math>I &lt; 40A</math></td> <td>35% (supply direct from building’s feeder circuit)</td> <td>40% (supply not direct from building’s feeder circuit)</td> </tr> <tr> <td><math>40A \leq I &lt; 80A</math></td> <td colspan="2">35%</td> </tr> <tr> <td><math>80A \leq I &lt; 400A</math></td> <td colspan="2">22.5%</td> </tr> </tbody> </table>	<u>Circuit fundamental current I</u>	<u>THD (%) in each phase</u>		$I < 40A$	35% (supply direct from building’s feeder circuit)	40% (supply not direct from building’s feeder circuit)	$40A \leq I < 80A$	35%		$80A \leq I < 400A$	22.5%	
		<u>Circuit fundamental current I</u>	<u>THD (%) in each phase</u>											
		$I < 40A$	35% (supply direct from building’s feeder circuit)	40% (supply not direct from building’s feeder circuit)										
		$40A \leq I < 80A$	35%											
$80A \leq I < 400A$	22.5%													
<p>If the manufacturer-provided driving controller when coupled with the motor meets the THD requirement, the installation of a correction device is not required.</p> <p>A correction device if needed can be installed at the motor control centre of the motor drive to improve the THD to the above corresponding tabulated levels.</p>														

The equipment supplier should assess the THD of the driving controller. The THD, measurable up to 31<sup>st</sup> harmonics, can be verified based on actual measurement, for lifts at rated load rated speed upward, and for escalators and passenger conveyors at no load rated speed. The THD of the driving controller contributes to the TPF of the circuit as stipulated in TG clause 8.5. (THD is also described in TG clauses 7.6 and 7.8).

For lifts, the THD requirement catering for the I<sup>2</sup>R losses is based on rated load, whereas for escalators and passenger conveyors given their frequent operation at no or low load it is based on no-load condition.

## 8.7 Metering & Monitoring Facilities

- (a) For purpose of better energy efficiency management, BEC clause 8.7 specifies the requirements on metering and monitoring facilities for each of the lifts, escalators or passenger conveyors, which are reproduced in table form in TG Table 8.7 below.

While simple ammeters and voltmeters can measure currents and voltages, which are sinusoidal, they alone cannot give accurate readings when harmonics are present, and also they cannot give readings of energy, maximum demand, TPF and THD, which have to rely on meters with data-logging and analytical function, such as a digital power analyzer or multi-function meter. The meters should be able to measure the parameters with true root mean square values given the presence of harmonic content in the measured circuit. . The REA/designers should submit the drawings to indicate the meters and the relevant technical document such as catalogues to substantiate the function and the details of installed meters.

It is common that the circuit from the isolator (connecting the lift, escalator or passenger conveyor to the building's electrical supply circuit) to the driving controller is a 3-wire circuit. A 3-CT meter configuration that employs three CTs, one for each phase with the value for the neutral calculated by the metering device, is generally acceptable.



<b><u>Table 8.7 : Parameters Requiring Measurement, for the Electrical Supply Circuit for the Motor Drive of Each Lift, Escalator or Passenger Conveyor</u></b>	
Metering devices (devices well fixed and secured in positions as a permanent installation)	<ul style="list-style-type: none"> <li>- Voltages (all phase-to-phase &amp; phase-to- neutral)</li> <li>- Currents (three phases and neutral)</li> <li>- Power (kW)</li> <li>- Total energy consumption (kWh)</li> <li>- Maximum demand (kVA)</li> <li>- TPF</li> <li>- THD (capable of measuring 31<sup>st</sup> and lower harmonic order)</li> </ul>
<p><i>Remarks:</i></p> <p><i>A 3-phase load incorporating VVVF or other similar power regulating technologies may experience up to the 25<sup>th</sup> and 27<sup>th</sup> harmonic content. Therefore a metering device measuring up to at least the 31st harmonic order should be used.</i></p>	

As a good engineering practice for permanent installation, the measured data may be transmitted for enhanced monitoring and control to the central control & monitoring system or BMS with energy management function.

Metering devices should be installed for each lift, escalator or passenger conveyor in accordance with BEC clause 8.7.1. An illustration of the provision of metering for lift and escalator are shown in TG Figure 8.7 (a) and (b) respectively. For measurement point for escalator at the local isolator, it is necessary to have solid wiring back to meter room or wireless connection allowing for viewing the measured data without affecting the normal operation of escalator. Measurement using wireless technology need to be connected to a network though Wi-Fi to allow signal transmission. Other than display at meter room, there are meters with wireless connection allow display on “cloud” and smartphone with corresponding software.

BEC clause 8.7.3 specifies the data acquisition to adopt the devices which has the capacity to store 36 months data where measurement parameters are trended every 15 minutes for fulfillment of the clause. Reference can also be made to TG Clause 7.7.

**Figure 8.7 (a) : Illustrative diagram of provision of metering device for lift**

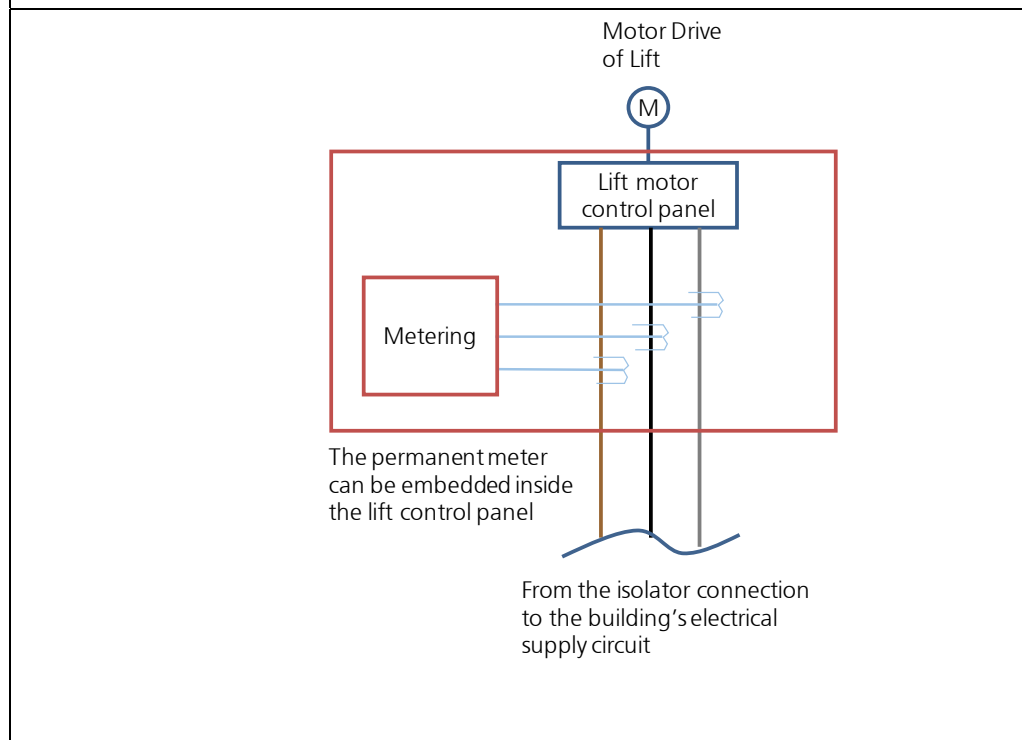
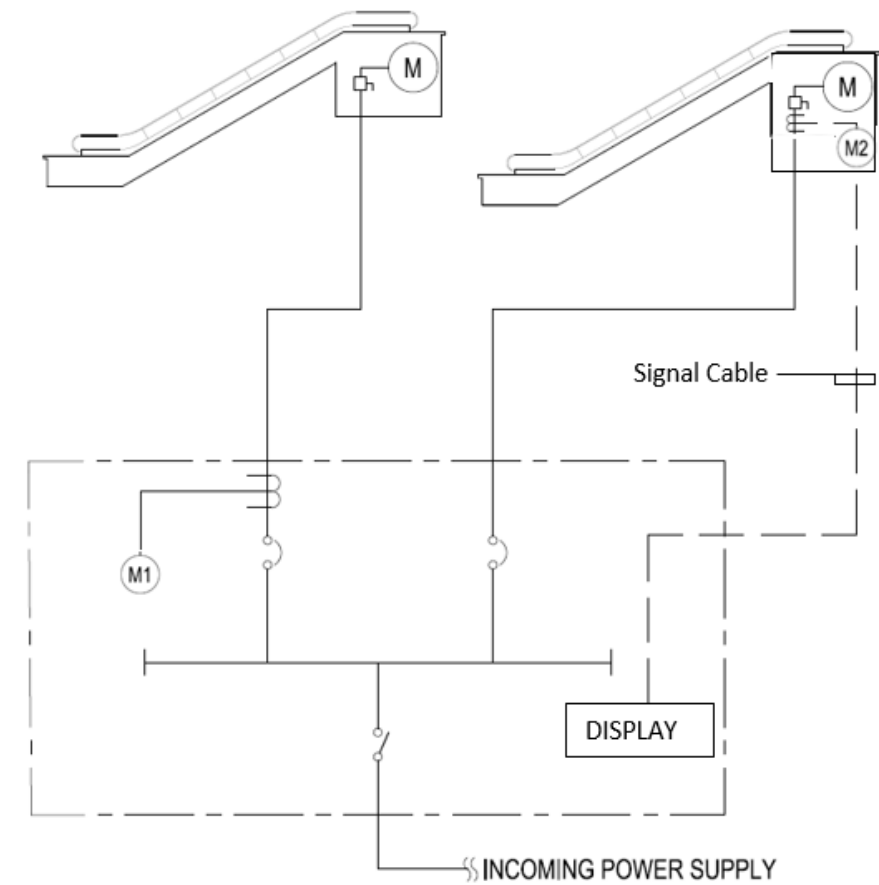


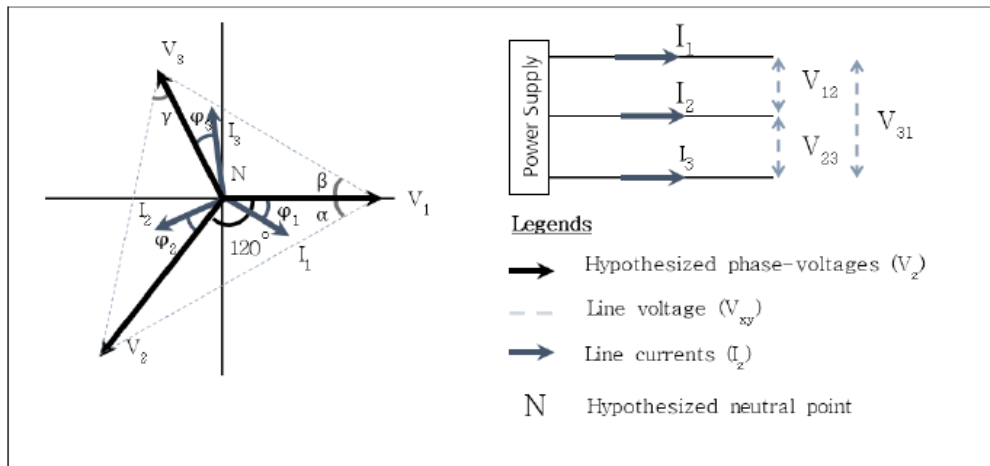
Figure 8.7 (b) : Illustrative diagram of provision of metering device for Escalator



- (M1) Metering device 1 taking measurement at the circuit protective device per BEC Clause 8.5.1.2 (b) and Clause 8.6.2 (b).
- (M2) Metering device 2 taking measurement at the local isolator per BEC Clause 8.5.1.2 (a) and Clause 8.6.2 (a).

(b) Site measurements on electrical power, TPF and THD to demonstrate the fulfilling of the corresponding requirements in BEC Section 8 are generally acceptable subject to as a minimum –

- the metering device for the measurement can account for harmonic currents up to the 31<sup>st</sup> order i.e. 31 x 50 Hz, and
- the total power factor calculation should be based on the calculation method stipulated in BEC Appendix B which is a new approach for obtaining the total power factor by on-site measurement of the line voltages and line currents with further calculation procedures. This approach aims at developing a consistent evaluation method to obtain the total power factor for three-phase three-wire power supply system by calculation of apparent power with on-site measurement as below:



**(i) Assumption**

It is assumed that the three hypothesized phase voltages  $V_1$ ,  $V_2$  and  $V_3$  having the neutral point  $N$  being derived with the three phase voltages ( $V_1$ ,  $V_2$  &  $V_3$ )  $120^\circ$  apart from one another

**(ii) On-Site Measurement**

The three Line Voltages of  $V_{xy}$  (i.e.  $V_{12}$ ,  $V_{23}$  and  $V_{31}$ ) and Line Currents of  $I_z$  (i.e.  $I_1$ ,  $I_2$  and  $I_3$ ), can be measured on site at the power supply system. Meanwhile, the Active Power ( $P$ ) can be read directly from the metering device based on two-wattmeter method

**(iii) Calculation of Hypothesized Phase Voltages (based on Cosine Rule)**

By Denoting  $\theta = \alpha + \beta$  and make use of the measured line voltages ( $V_{xy}$ ) into equations B6 & B7, the value of  $\theta$ ,  $\alpha$  and  $\beta$  can be obtained.

$$\theta = \cos^{-1} \left[ \frac{|V_{12}|^2 + |V_{31}|^2 - |V_{23}|^2}{2|V_{31}||V_{12}|} \right] \quad (B6)$$

$$\alpha = \tan^{-1} \left[ \frac{\sin(\frac{\pi}{3}) - \frac{|V_{31}|}{|V_{12}|} \sin(\frac{\pi}{3} - \theta)}{\cos(\frac{\pi}{3}) + \frac{|V_{31}|}{|V_{12}|} \cos(\frac{\pi}{3} - \theta)} \right] \quad (B7)$$

$$\beta = \theta - \alpha \quad (B8)$$

The value of  $\theta$ ,  $\alpha$  and  $\beta$  above can then be applied in equation B3, B4 & B5 to obtain the hypothesized phase voltages  $V_1$ ,  $V_2$ ,  $V_3$

$$|V_1| = |V_{31}| \frac{\sin(\frac{\pi}{3} - \beta)}{\sin(\frac{2\pi}{3})} \quad (B3)$$

$$|V_2| = |V_{12}| \frac{\sin(\alpha)}{\sin(\frac{2\pi}{3})} \quad (B4)$$

$$|V_3| = |V_{31}| \frac{\sin(\beta)}{\sin(\frac{2\pi}{3})} \quad (B5)$$

**(iv) Calculation of Apparent Power and Total Power Factor**

The calculated Apparent Power (S) can be further obtained by using the hypothesized phase voltages and the measured line current with equation B2.

$$S = |V_1||I_1| + |V_2||I_2| + |V_3||I_3| \quad (B2)$$

Afterwards, the calculated total power factor should be represented by the division between active power (P) and apparent power (S).

$$\text{Total Power Factor} = \frac{\text{Active Power (P)}}{\text{Apparent Power (S)}} \quad (B1)$$

## 9. Performance-based Approach

### 9.1 Scope of Application (BEC clause 9.1)

BEC Section 9 provides the guidelines for the performance-based approach, which is regarded as an alternative approach to meet all the prescriptive requirements in Sections 5 to 8 in respect of installations of lighting, air-conditioning, electrical and lift and escalator.

For a building design that fully complies with BEC Sections 5 to 8, the seeking of BEC compliance under the performance-based approach is not required. Nevertheless the calculation of the energy performance of the building design based on the modeling and simulation techniques specified in BEC Section 9 is encouraged as a good engineering practice.

#### 9.1.1 Comprehensive View on Applicability

To gain a comprehensive view embracing the performance-based approach in relation to the Ordinance, BEC clause 9.1 should be read in conjunction with –

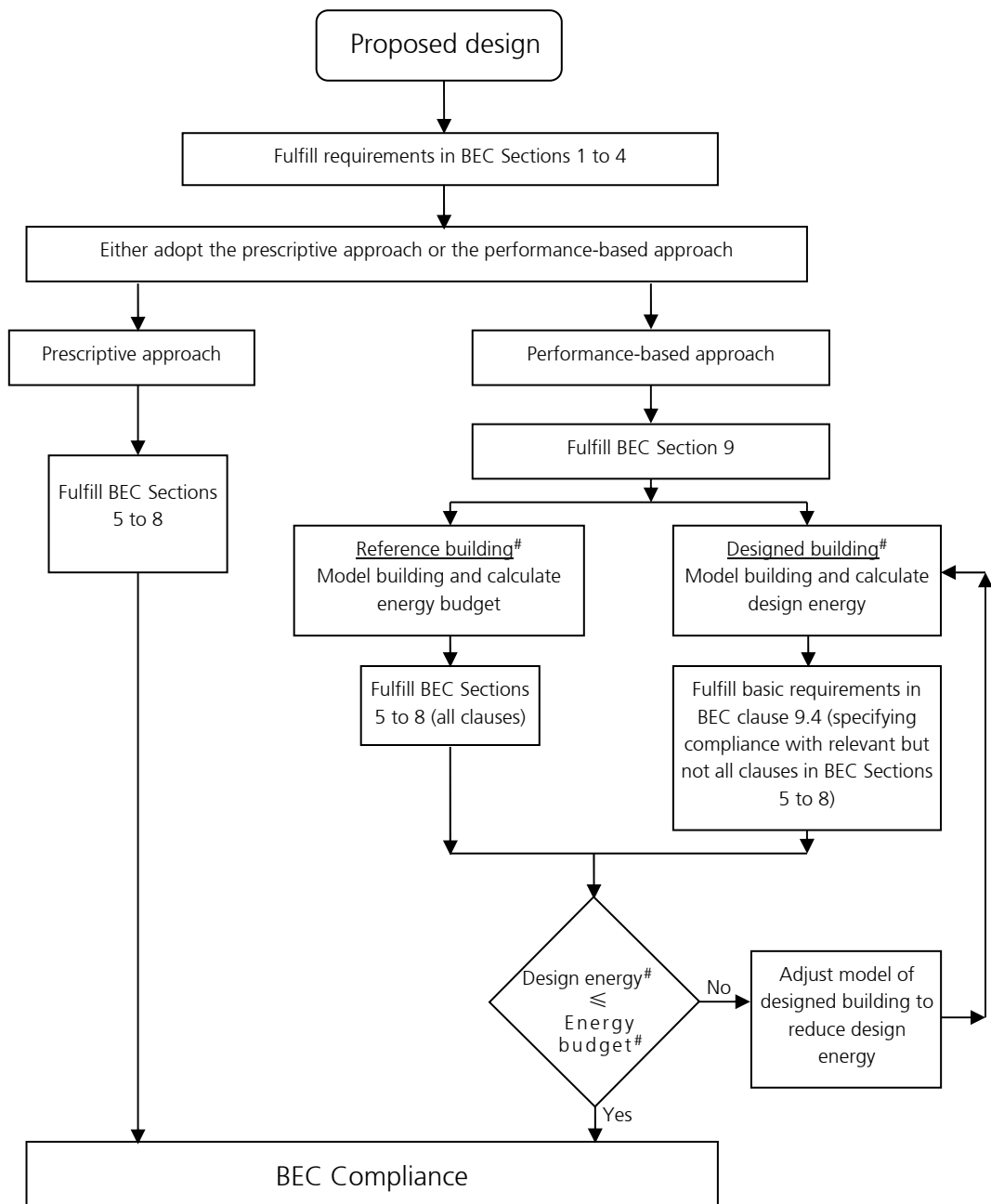
- BEC Sections 3 & 4 that briefly describe the scope and limits of the application of the Ordinance based on its prescribed requirements in Parts 2 & 3;
- BEC clauses 5.1 to 5.3, 6.1 to 6.3, 7.1 to 7.3 and 8.1 to 8.3, the clauses on scope of application, general approach and definitions in the respective sections, their applicability of which are affirmed for the avoidance of doubt in BEC clause 9.1.2; and
- TG Sections 3 & 4 that elaborate on the scope and limits of application and the necessary steps to demonstrate the compliance with the Ordinance and the BEC.

### 9.2 General Approach (BEC clause 9.2)

The requirements specific for the performance-based approach in BEC clauses 9.4 and 9.5 are based on the general approach to energy efficiency given in BEC clause 9.2. TG Figure 9.2 below gives a flow chart indicating the process of BEC compliance by virtue of the performance-based approach as an alternative to the prescriptive full compliance with BEC Sections 5 to 8.

With the focus on requiring the calculation of the annual total energy consumption of the building under design, the REA/designer can tell and thus the building owner can be informed at the design stage of the energy performance of the designed building, and the choice of the final design can be based on an evaluation of the energy performances of the different design options.

**Figure 9.2 : BEC compliance approach**



# Remarks -

- Designed building means the building or unit for which compliance with this BEC based on the performance-based approach BEC Section 9 is being sought, and includes its building envelope, building services installations and energy consuming equipment.
- Reference building means a building design of the same size and shape as the designed building or unit, modeled in accordance with the requirements given in BEC Section 9 and with corresponding building services installations fully satisfying the energy efficiency requirements given in BEC Sections 5 to 8.
- Design energy means the total energy consumption of the designed building modeled in accordance with the requirements given in BEC Section 9.
- Energy budget means the total energy consumption of the reference building modeled in accordance with the requirements given in BEC Section 9.

### 9.3 Definitions (BEC clause 9.3)

BEC Section 2 provides the interpretations and abbreviations related to the BEC and the Ordinance, including those for the performance-based approach.

### 9.4 Basic Requirements (BEC clause 9.4)

The items listed in BEC Table 9.4 are termed as trade-off allowable items as stipulated in BEC clause 9.4.1. The trade-off allowable items of the designed building should have the energy efficiency performance of not exceeding 25% lower than the corresponding prescriptive requirements given in Section 5 to 8 of the BEC.

Those items not listed in BEC Table 9.4 are basic and the prescriptive requirements that are applicable to the designed building.

The trade-off allowable items plus the basic and the prescriptive requirements constitute the energy performance requirements in BEC Sections 5 to 8.

The above trade-off allowable provision serves to encourage design flexibility and innovative design. Example of one being a lighting installation that has a higher installed lighting power density but a lower actual energy consumption as a result of its energy efficient through extensive automatic lighting control exceeding the prescribed requirements under BEC clause 5.6.

### 9.5 Comparison of Design Energy & Energy Budget (BEC clause 9.5)

BEC clause 9.5 requires the comparison of the “building design to be adopted” or the designed building, with “itself at a slightly different condition” or the reference building. The slightly different condition refers to the full compliance with all the prescriptive requirements in BEC Sections 5 to 8, whereas on the other hand the designed building can be exempted from certain requirements, the trade-off allowable requirements. Having so given the exemption, the adoption of the exemption can be selective and not exhaustive; an example being that the adoption of the exemption on lighting power density can be confined to say a small percentage instead of all of the lighting spaces of the designed building.

BEC clauses 9.5.1 and 9.5.2 and BEC Appendix A give the requirements on the modeling of both the designed building and the reference building and the calculation of their corresponding annual total energy consumptions, respectively the design energy and the energy budget. The essence of the performance-based approach is that the design energy should not exceed the energy budget (as specified in BEC clause 9.5.3), which means that the designed building is at least as energy efficient as its reciprocal building, the reference building, and the achievement is by means of adopting for certain relevant items a more energy efficient design than one that complies with the applicable relevant requirement in BEC Section 5 to 8. As an



encouragement to the more energy efficient design, it is allowed to trade-off its energy reduction with that of the trade-off allowable requirements described in BEC and TG clause 9.4.

Additional rules for the trade-off are given in BEC clauses 9.5.4. Below give certain guidelines to these rules.

#### OTTV

The trade-off of energy can be achieved by making use of a better OTTV to lower the design energy. However, such approach is only allowed for those buildings under the scope of coverage of the Building (Energy Efficiency) Regulation (Cap 123M) that mandates the OTTV requirements of the commercial buildings and hotels with first building plans submitted after 21 July 1995. Care should be taken that the above mentioned "commercial buildings" are defined under section 2 of Cap 123M. The definition is not exactly the same as the "commercial building" under the BEEO.

#### Trade-off items under same ownership

The items or installations involved in the trade-off process should be under the same ownership. For example, the energy increase of a tenant owned lighting installation (usually in the tenant occupied space) cannot be off-set with the energy reduction from the central chiller plant owned by the building owner. However, the limitation on the same ownership is not applicable to the case when the trade-off involves remote cooling source (e.g. in a campus-like development where the cooling comes from the energy centre of the development under same ownership)

#### Subsequent alteration or replacement

Any subsequent alteration, replacement or adjustment of items or installations previously involved in a trade-off should always result in an overall design energy not exceeding the energy budget. For example, if a photovoltaic system previously involved in a trade-off is to be demolished for whatever reasons, the building's calculated annual total building energy consumption should be reassessed to identify if the design energy has exceeded the energy budget as a result of the demolition, and if yes certain compliance retrofitting should be carried out to reduce the design energy to not exceeding the energy budget. Another example is a retrofit of the lighting installation previously involved in a trade-off, which should not be retrofitted with less energy efficient luminaires to increase the design energy to above the energy budget.

#### On-site renewable energy and recovery energy

The BEC clause 9.5.4.6 specifies the requirement of metering and monitoring facilities for the equipment of system energy recovery captured or renewable energy generated on site. The monitoring record could be used to verify the energy

generated or energy saving from the system. The parameters to be measured and monitoring are stipulated in Table 9.5 below:

<b>Table 9.5 : Examples of Parameters Requiring Measurement for Renewable Energy and Recovery Energy Systems</b>	
Equipment or system generating electric energy e.g. Photovoltaic Wind turbine	<ul style="list-style-type: none"> <li>- Voltages (all phase-to-phase &amp; phase-to- neutral)</li> <li>- Currents (three phases and neutral)</li> <li>- Power (kW)</li> <li>- Total energy consumption (kWh)</li> <li>- Maximum demand (kVA)</li> <li>- TPF</li> <li>- THD (capable of measuring 31<sup>st</sup> and lower harmonic order)</li> </ul>
Equipment or system recovering or generating thermal energy e.g. Heat wheel	<ul style="list-style-type: none"> <li>- Power input (kW) &amp; Energy input (kWh) (e.g. Electricity input for motor for heat wheel in AHU)</li> <li>- Enthalpy difference across the equipment (kJ/kg of dry air)</li> <li>- Air Flowrate (L/s)</li> <li>- Operating hour (no. of hour)</li> <li>- Moisture Content (kg/kg of dry air)</li> </ul>

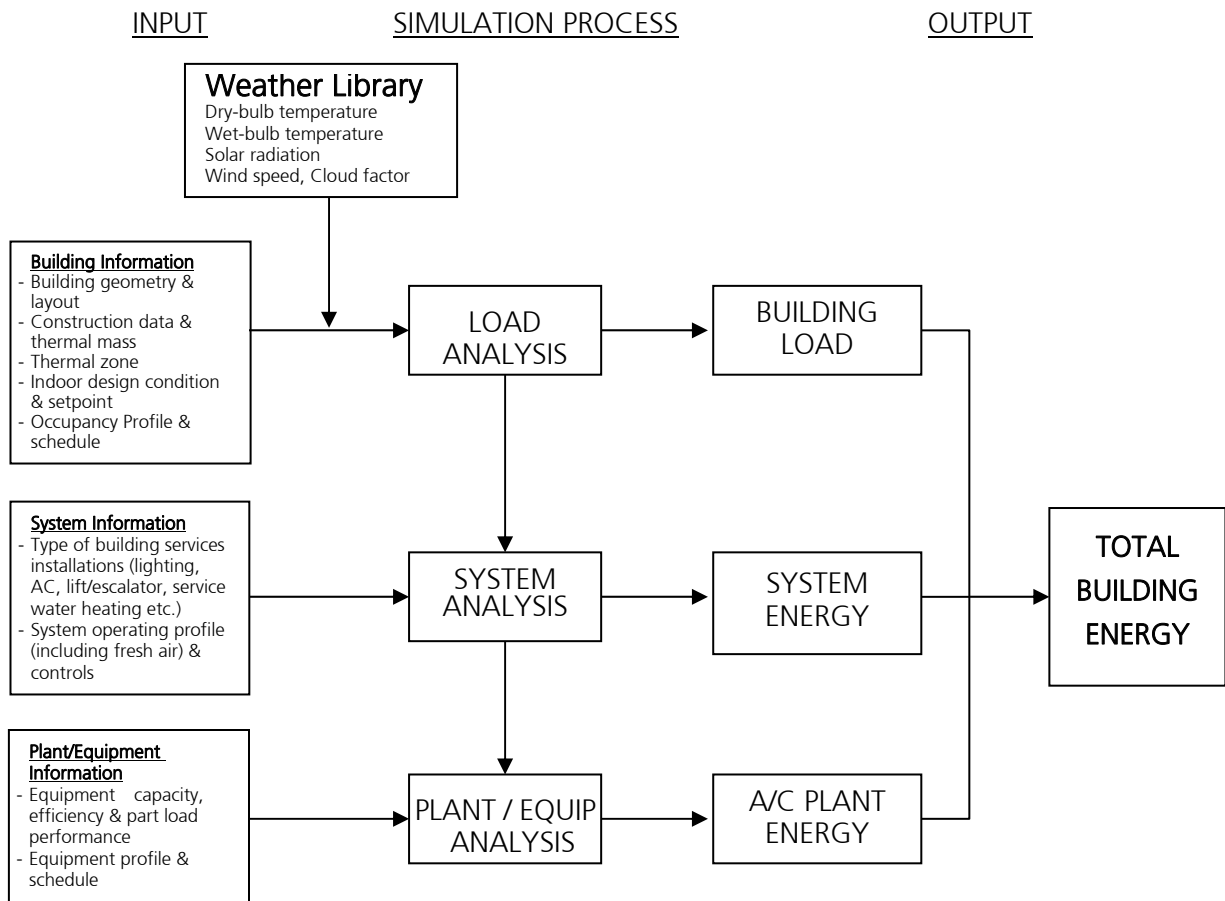
Items not installed

An item or installation not yet installed should not be involved in the trade-off, as its installation at a later date cannot be guaranteed.

9.6 Numerical Method for Building Energy Analysis (BEC Appendix A)

BEC Appendix A gives the guidelines on the numerical method for building energy analysis which usually relies on computer simulation. A snapshot of the simulation process is shown in TG Figure 9.6 below.

**Figure 9.6 : Simulation process in numerical method for building energy analysis**



TG Table 9.6 below shows certain public domain available computer simulation programs commonly used in Hong Kong by building designers in the calculation of annual total building energy consumption. Their listing serves only as a reference source of simulation programs, and does not imply they fully meet ALL the requirements in BEC Appendix A.

<b>Table 9.6 : Commonly Used Building Energy Simulation Programs</b>	
<b>Program</b>	<b>Information Source</b>
DOE-2. PC version/interface of DOE-2 and DOE-2 derivatives : • eQuest	(supported by U.S. Department of Energy)  <a href="http://doe2.com/">http://doe2.com/</a>
EnergyPlus	(supported by U.S. Department of Energy) <a href="https://energyplus.net/">https://energyplus.net/</a>
HAP	<a href="https://www.carrier.com/commercial/en/us/software/hvac-system-design/hourly-analysis-program/">https://www.carrier.com/commercial/en/us/software/hvac-system-design/hourly-analysis-program/</a>
TRACE 700	<a href="http://www.trane.com/Commercial/DNA/View.aspx?i=1136">http://www.trane.com/Commercial/DNA/View.aspx?i=1136</a>
TRNSYS	<a href="http://www.trnsys.com/">http://www.trnsys.com/</a>
Tas	<a href="http://www.edsl.net/">http://www.edsl.net/</a>
ESP-r	<a href="http://www.esru.strath.ac.uk/Programs/ESP-r.htm">http://www.esru.strath.ac.uk/Programs/ESP-r.htm</a>
IESVE	<a href="http://www.iesve.com/">http://www.iesve.com/</a>
Ener-Win	<a href="http://pages.suddenlink.net/enerwin/">http://pages.suddenlink.net/enerwin/</a>
BEEP	<a href="http://www.bse.polyu.edu.hk/research/BEP/BEEP/BEEP.htm">http://www.bse.polyu.edu.hk/research/BEP/BEEP/BEEP.htm</a> (though accounted for in cooling load & cooling energy calculation, lighting electrical energy is not summed up & output as a single consumption figure)

Some programs may have certain minor inadequacy, which however may not significantly affect the overall simulation results when the data input is handled with care and professional skill.

#### Weather file

Weather data of the example or typical weather year of Hong Kong should be used in the numerical analysis. The weather data file can be plugged into the simulation program for the analysis. A source on the public domain for downloading a Hong Kong weather file is as follows –

[https://energyplus.net/weather-region/asia\\_wmo\\_region\\_2/CHN%20%20](https://energyplus.net/weather-region/asia_wmo_region_2/CHN%20%20)

### 9.7 Simple Comparison between BEAM Plus Energy Model and Performance-based model

BEAM Plus certification usually includes a credit related to energy modelling. There are a number of similarities in the modelling setting in both cases. Usually, the baseline setting of BEAM Plus is referenced from the latest building energy code

requirement while the proposed case setting is the as-design case. Such energy models could act a good basis for applicants to go for performance-based approach. Here is the summary of comparison between the BEAM Plus v2.0 and performance-based approach of a commercial building types for reference. Detail requirement should be referred to the corresponding guidelines.

<b>Table 9.7 : Simple Comparison between BEAM Plus energy model and performance-based model</b>		
<b>Baseline model/Reference model</b>	<b>BEAM Plus</b>	<b>BEC performance based</b>
Envelope	The envelope parameters should be adjusted to meet the OTTV requirement	
Air-conditioning	Depending on the air-conditioned floor area, there is different air-conditioning systems	The air-conditioning systems, zoning and equipment types of the reference building should be identical to the designed building; but the system and equipment of the reference building should exactly meet the relevant requirements in Section 6 of this BEC
Lift and Escalator	The system and equipment of the reference building should exactly meet the relevant requirements in Section 8 of this BEC	
Lighting	The LPD in each space should be the corresponding maximum allowable value given in Table 5.4 of this BEC	
Other systems	Other systems and miscellaneous loads, if they are considered, should be modelled as identical to those in the designed building	

However, there is still requirement about the extent of the percentage of trade-off performance of building services installations as shown in Table 9.4.

### 9.8 Simple Case Study Example of Trade-off for Performance-based Approach

#### Background/Issue

An office building with internal floor area 40,00m<sup>2</sup> is served by air-cooled chillers with total cooling capacity as 7,000kW. The designer decided to create an extra-ordinary light scene at common area such as entrance lobby and atrium. As a result, the lighting power density at those areas did not fulfill the prescriptive LPD requirement.

The lighting power density of entrance lobby and atrium were 14 W/m<sup>2</sup> and 21 W/m<sup>2</sup>. Both fails the prescriptive requirement of maximum allowable LPD 11.5 W/m<sup>2</sup> and LPD 17.0 W/m<sup>2</sup> under Table 5.4 of BEC 2021. However, the selection of higher efficient screw chiller was out-performed the BEC requirement. Therefore, the designer/REA decided to opt for performance-based approach as an alternative fulfillment.

Performance-based Approach

Two energy models were built with one as reference building in accordance with the requirements given in BEC Section 9 and one design building following the as-design parameters.



Table 9.8.1 Summary of input parameters (simplified)

Parameters		Reference Building	Design Building
Lighting – LPD	Entrance lobby	11.5	14
	Atrium	17	21
AC system - COP	COP of Screw chillers	3.1	3.3

The result of the energy models are listed as below.

Table 9.8.2 Total annual energy consumed in Reference Building and Design Building

	Reference Building	Design Building
Lighting Annual Energy Consumption	1,204,800 kWh	1,315,900 kWh
AC Annual Energy Consumption	2,680,400 kWh	2,560,000 kWh
Other Consumptions (i.e lifts, equipment, etc)	2,074,800 kWh	2,035,600 kWh
Total Annual Energy Consumption	5,960,000 kWh	5,911,500 kWh

Therefore, in performance-based approach, the total energy consumed in Design Building < Reference Building, the scenario complies the requirement of trade-off. In addition, the trade-off on LPD does not exceed 25% of the corresponding prescriptive requirement.

## 10. Energy Efficiency Requirements for Major Retrofitting Works

### 10.1 Scope of Application (BEC clause 10.1)

#### 10.1.1 Comprehensive View on Applicability and BEC Table 10.1

BEC Section 10, BEC Table 10.1 in particular, on major retrofitting works provides the comprehensive view on what constitute major retrofitting works based on the 500 m<sup>2</sup> works area criterion and the main CBSI component criterion. BEC Table 10.1 lists the details on the category of the works, the relevant conditions for applicability of BEC requirement, and the applicable BEC requirements and corresponding BEC clause numbers. (CBSI is explained in TG clause 4.2.4.) This section, TG Section 10, gives the further guidance on how to check if a works item falls within the scope of major retrofitting works based on BEC Table 10.1.

A textual description of the checking process in BEC Table 10.1 is given in TG clause 10.1.2 below. To provide a diagrammatic view of the checking process, a flow chart (TG Figure 10.1) is given in TG clause 10.1.3. Examples of work items regarded as major retrofitting works are also given in TG clauses 10.1.4 and 10.1.5.

Attention is drawn that works that appear to fall within major retrofitting works by virtue of meeting the 500 m<sup>2</sup> criterion or CBSI main component criterion may not necessarily fulfil the conditions for applicability, which simply means that there are no applicable BEC requirements. For easy cross-reference, the item and sub-item numbering in BEC Table 10.1 are same as those in TG Figure 10.1. It should also be noted that in BEC Table 10.1 the capacity related conditions for applicability, namely 3 kW lighting circuit in sub-item (a)(i), 60 kW cooling/heating in sub-item (a)(ii), 400 A electrical circuit rating in sub-item (b)(i) and 350 kW cooling/heating in sub-item (b)(ii) refer to the capacity of the replacement or replacing equipment.

The above mentioned capacity related conditions for applicability exclude those installations prescribed under Schedule 2 of the Ordinance. For example, lighting solely for decoration purpose does not count as the 3 kW lighting circuit in BEC Table 10.1 sub-item (a)(i) and AHU solely for research purpose does not count as the 60 kW cooling/heating capacity in BEC Table 10.1 sub-item (a)(ii).

#### 10.1.2 Textual Description of Checking Process in BEC Table 10.1

10.1.2.1 When referring to BEC Table 10.1, first identify if the works are preliminarily regarded as major retrofitting works by the works area criterion of 500 m<sup>2</sup>, or by the CBSI main component criterion; for the former item (a) of the table is applicable, and for the latter item (b) of the table is applicable. The following paragraphs give the approach for works with item (a) applicable, of which a similar approach may be adopted for works with item (b) applicable.



Attention is drawn to the definition of major retrofitting works in item (a) and item (b) are not mutually exclusive. For example, works classified as major retrofitting works under item (b) due to CBSI replacement may also be regarded as major retrofitting works under item (a) if the works area over 500 m<sup>2</sup>. The corresponding sub-item (a)(i), (a)(ii) and (a)(iii) should also be complied. Consider a hotel building carries out lighting installation (regarded as CBSI) replacement involving luminaires with a total circuit wattage exceeding 3kW. Although the work does not fulfill the sub-item (b)(i), (b)(ii) and (b)(iii), FOC submission is still required if the works area over 500 m<sup>2</sup> as the lighting installation must be a BSI and fulfill the criteria in sub-item (a)(i).

Under either items (a) or (b) under BEC Table 10.1, there are respectively five columns. In checking the applicability of the requirements cited in columns four and five in the table, the category of the works in column one and the conditions for applicability should be first checked. The conditions for applicability are given in columns two and three (for certain rows the contents under both columns are integrated in a single cell for simplicity).

- 10.1.2.2 Take for example a retrofit of building services installations involving a works area of 500 m<sup>2</sup>, which fulfills item (a), and involving the addition or replacement of luminaires. The retrofit thus fulfills the descriptions in sub-item (i) under item (a). From here proceed to the cell in column two, which reads "***total circuit wattage of the additional or replacement luminaires at or exceeding 3kW***". Should the total circuit wattage of the retrofit be less than 3kW, the retrofit would not be regarded as major retrofit works.

Should the total circuit wattage be of 3kW or more, proceed further to column three, which has two rows, and the contents in each should be examined. The cell in the first row reads "***no existing luminaires in the area, or the sum of circuit wattage of additional or replacement luminaires is more than 50% of the original luminaires in the area***". It follows that should the additional or replacement luminaires be not more than 50% of the original luminaires in circuit wattage the retrofit is not regarded as major retrofitting works, whereas should the retrofit involves a more than 50% of the original luminaires in circuit wattage the retrofit is regarded as major retrofit works and has to comply with the requirements cited in the cells in columns four and five, that is the lighting power density (LPD) in the space has to comply with the requirements specified in BEC clause 5.4. Whether a given lighting space is provided with **existing luminaires** (in particular when involving luminaires left ready by developer or building owner for the future tenant), reference should be made to the discussion on TG clause 10.1.8, TG Table 10.1.8 (1) and TG Table 10.1.8 (2).

Finishing off with this row, proceed to the cell in the next row of column three, which reads "***the area has no existing luminaires, or the work involves a complete rewiring of the existing lighting circuits in the area***", and should the condition not be

applicable there is no further requirement, whereas should the condition be fulfilled the requirements cited in the cells in columns four and five should be complied with, those are the lighting control point and automatic lighting control of the retrofit should comply with the requirements specified in BEC clause 5.5 and 5.6 respectively.

Attention is drawn that should the works area be an aggregate of floor area of several places, the condition for applicability in column three would apply to each of these places, and it follows that the place not fulfilling the conditional applicability would not be governed by the respective BEC requirement in columns four and five (refers to the illustrative example in TG clause 10.1.4.3 and TG Table 10.1.4.3).

10.1.2.3 Should the above retrofit involves, in addition to lighting, the addition or replacement of AHU(s), unitary air-conditioner(s), VRF System(s), Heat Pump(s), and/or chiller(s), the retrofit also fulfills the descriptions in sub-item (ii) under item (a). From this point proceed to the cell in the column two, which reads "***total cooling/heating capacity of the additional or replacement air handling unit(s), unitary air-conditioner(s), VRF System(s), Heat Pump(s), and/or chiller(s) at or exceeding 60kW***". Should the 60kW rating not be fulfilled there is no further requirement in respect of air-conditioning, whereas should the 60 kW rating be fulfilled each of the conditions cited in the cells in column three should be checked and the respective requirements in the cells in columns four and five be complied with accordingly.

10.1.2.4 Should the above retrofit involves, in addition, also the works described in sub-item (iii) under item (a), the conditions under the item should also be checked and the applicable requirements be complied with.

10.1.3 Flow Chart on Checking Process in BEC Table 10.1

TG Figure 10.1 below gives, in the form of a flow chart, the guidance on the checking process of BEC Table 10.1, with examples indicating the flow chart process given in TG clauses 10.1.4 and 10.1.5.

Figure 10.1 : Flow chart illustrating what are regarded as major retrofitting works and the corresponding BEC requirements based on BEC Table 10.1

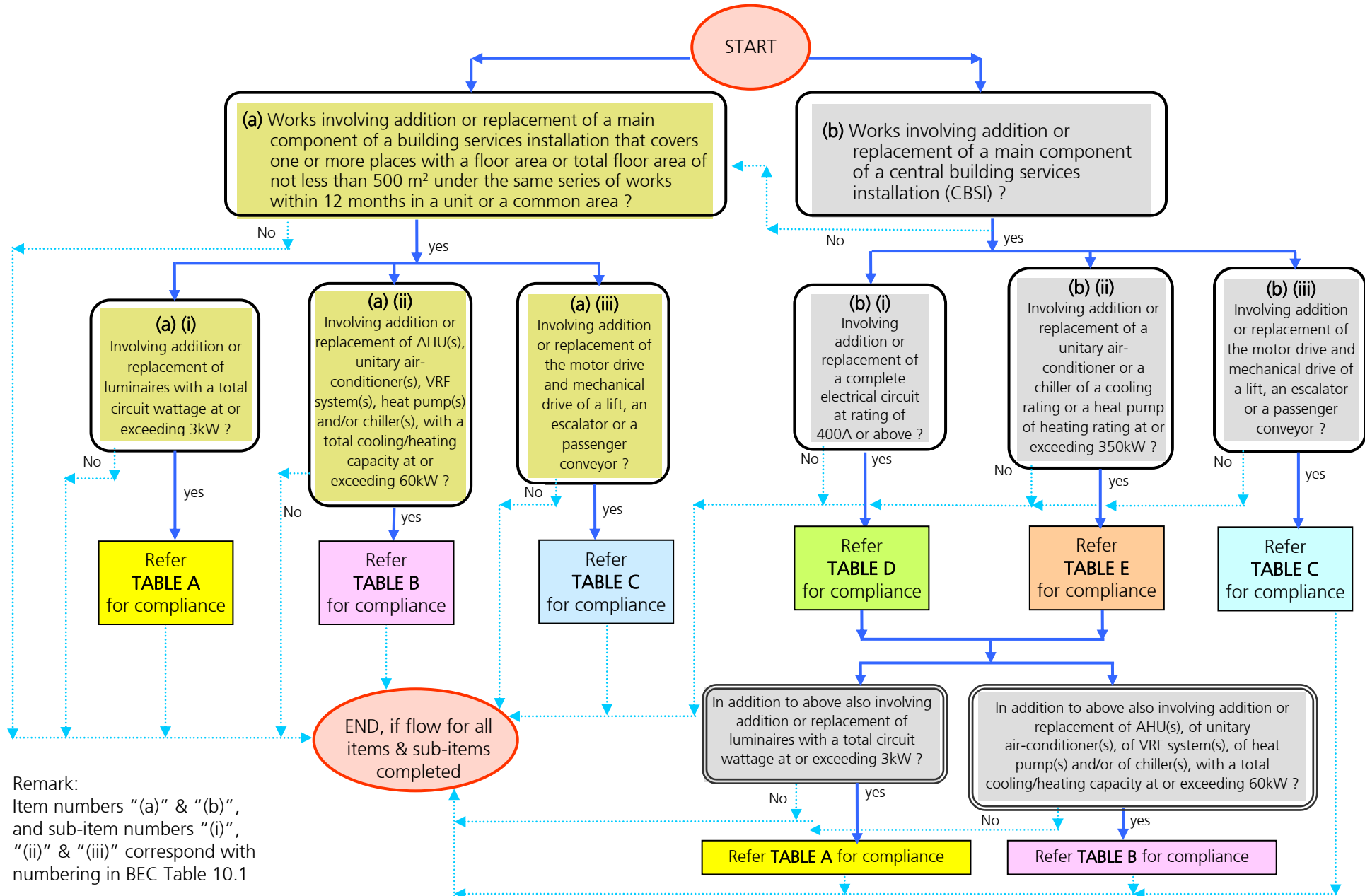


Figure 10.1 : Flow chart illustrating what are regarded as major retrofitting works and the corresponding BEC requirements based on BEC Table 10.1 (Continued)

TABLE A		TABLE B		TABLE C		TABLE D		TABLE E	
Condition for Applicability	Applicable BEC Requirement	Condition for Applicability	Applicable BEC Requirement	Condition for Applicability	Applicable BEC Requirement	Condition for Applicability	Applicable BEC Requirement	Condition for Applicability	Applicable BEC Requirement
no existing luminaires in the area, or the sum of circuit wattage of additional or replacement luminaires is more than that of 50% of the original luminaires in the area	lighting power density, BEC clause 5.4	involving addition or replacement of unitary air- conditioner, VRF system, heat pump, cooling tower and/or chiller	air- conditioning equipment efficiency, BEC clause 6.12	the work involving a traction drive lift with machine above and with 1:1 or 2:1 suspension roping system, a hydraulic lift, an escalator or a passenger conveyor	electrical power, BEC clause 8.4	the work involving a complete main circuit, except for cable route between existing transformer room and associated LV switch room with length exceeding 20 m	distribution loss, BEC clause 7.4.2	applicable in any conditions; the work involving addition or replacement of cooling tower	air- conditioning equipment efficiency, BEC clause 6.12
the area has no existing luminaires, or the work involves a complete rewiring of the existing lighting circuits in the area	lighting control point, BEC clause 5.5 Automatic lighting control, BEC clause 5.6	the additional or replacement AHU(s) forming a complete air distribution system in the context of BEC clause 6.7	separate air distribution system for process requirements, BEC clause 6.5	the work involving a traction drive lift, a hydraulic lift, an escalator or a passenger conveyor	total power factor, BEC clause 8.5.1	the work involving a complete feeder	distribution loss, BEC clause 7.4.3	the additional or replacement of air-conditioning equipment involving addition or complete replacement of corresponding water side pumping system	frictional loss of water piping system, BEC clause 6.9
			air distribution system fan power, BEC clause 6.7		total harmonic distortion, BEC clause 8.6	the work involving a complete sub-circuit	distribution loss, BEC clause 7.4.4		energy metering, BEC clause 6.13
			direct digital control, BEC clause 6.14		metering & monitoring facilities, BEC clause 8.7	the work involving a complete final circuit	distribution loss, BEC clause 7.4.5		direct digital control, BEC clause 6.14
		the work involving additional water pipework	frictional loss of water piping system, BEC clause 6.9		the work involving a complete feeder, or involving a complete sub-circuit and all its downstream final circuits	total power factor, BEC clause 7.6.1 total harmonic distortion, BEC clause 7.6.2 balancing of single-phase loads, BEC clause 7.6.3	ditto, the corresponding water side pumping system forming an independent system	pumping system variable flow, BEC clause 6.8	
		the work involving a complete replacement of corresponding water side pumping system		the work involving a main circuit, a feeder or a sub-circuit, with addition of corresponding switch cubicle for the circuit termination at the main LV switchboard	metering & monitoring facilities, BEC clause 7.7	the work involving addition or replacement of pipework, ductwork or AHU	thermal insulation, BEC clause 6.11		
		the work involving additional or replacement pipework, ductwork or AHU	thermal insulation, BEC clause 6.11	the work involving addition of a lift or replacement of a lift car	lift decoration load, BEC clause 8.5.2 lift ventilation & air conditioning, BEC clause 8.5.4 lighting power density, BEC clause 5.4 automatic lighting control, BEC clause 8.5.6	the work involving addition or replacement of water pump with new motor, of AHU with new motor, or of fan with new motor	motor efficiency, BEC clause 7.5.1		
		the work involving addition or replacement of water pump with new motor, of AHU with new motor, or of fan with new motor	motor efficiency, BEC clause 7.5.1						

#### 10.1.4 Examples of Major Retrofitting Works by Virtue of Fulfilling the 500 m<sup>2</sup> Works Area Criterion

Examples of work items regarded as major retrofitting works are given in TG clauses 10.1.4.1 to 10.1.4.4.

- 10.1.4.1 Consider a retrofit involving the replacement of a number of AHUs serving specific units, which have a total cooling capacity of 300 kW. The replacement includes the AHU fan motors, and each AHU serves specific unit(s). There are no changes to the existing pipework, ductwork and electrical circuitries for each of the AHUs, except at the interfacing with the new AHU where certain modification works are required to facilitate the replacement. The total works area for the retrofit is 550 m<sup>2</sup> and the works are of the same series within a 12-month period.

The applicability, based on TG Figure 10.1, of the category of work, the conditions for applicability, and the applicable requirements are indicated in TG Figure 10.1.4.1, against a miniature background of TG Figure 10.1, in which the applicable boxes and cells in the figure are circled with insertion of explanatory text boxes.

As shown in TG Figure 10.1.4.1, the retrofit is likely regarded as major retrofitting works by the works area criterion of 500 m<sup>2</sup>. However the AHUs are not regarded as a CBSI since each AHU serves specific unit(s). The total cooling capacity of the replacement AHUs fulfils the condition for applicability of at or exceeding 60 kW (sub-item (a)(ii) in BEC Table 10.1), and thus the requirements in TG Figure 10.1 TABLE B are relevant – the interfacing pipework and ductwork are governed by BEC clause 6.11 in respect of requirements on thermal insulation, and the motors of the AHUs are governed by BEC clause 7.5.1 in respect of motor efficiency. The energy efficiency requirements in the other rows of TABLE B are not applicable, given the conditions of applicability being not fulfilled.

Attention is drawn that a fan coil unit (FCU) is analogous to an AHU in the BEC, and a retrofit of FCU should be handled in the same manner as for the AHU, except that the BEC does not have specific requirements in respect of motor efficiency on FCU motors (commonly single-phase and with rated output less than 0.75 kW (BEC Table 7.5.1)).

- 10.1.4.2 Consider the same retrofit above, but this time certain luminaires within the works area are to be replaced too, and the total circuit wattage of the replacement luminaires is 2 kW. In this example, the applicable energy efficiency requirements are same as in the example above. The luminaires' total circuit wattage is less than 3 kW, which does not fulfil the condition for applicability of at or exceeding 3 kW (sub-item (a)(i), Table 10.1), and hence the luminaires are not governed by the energy efficiency requirements in TG Figure 10.1 TABLE A.

Figure 10.1.4.1 : Illustration, against background of TG Figure 10.1, of energy efficiency requirements for examples in TG clause 10.1.4.1

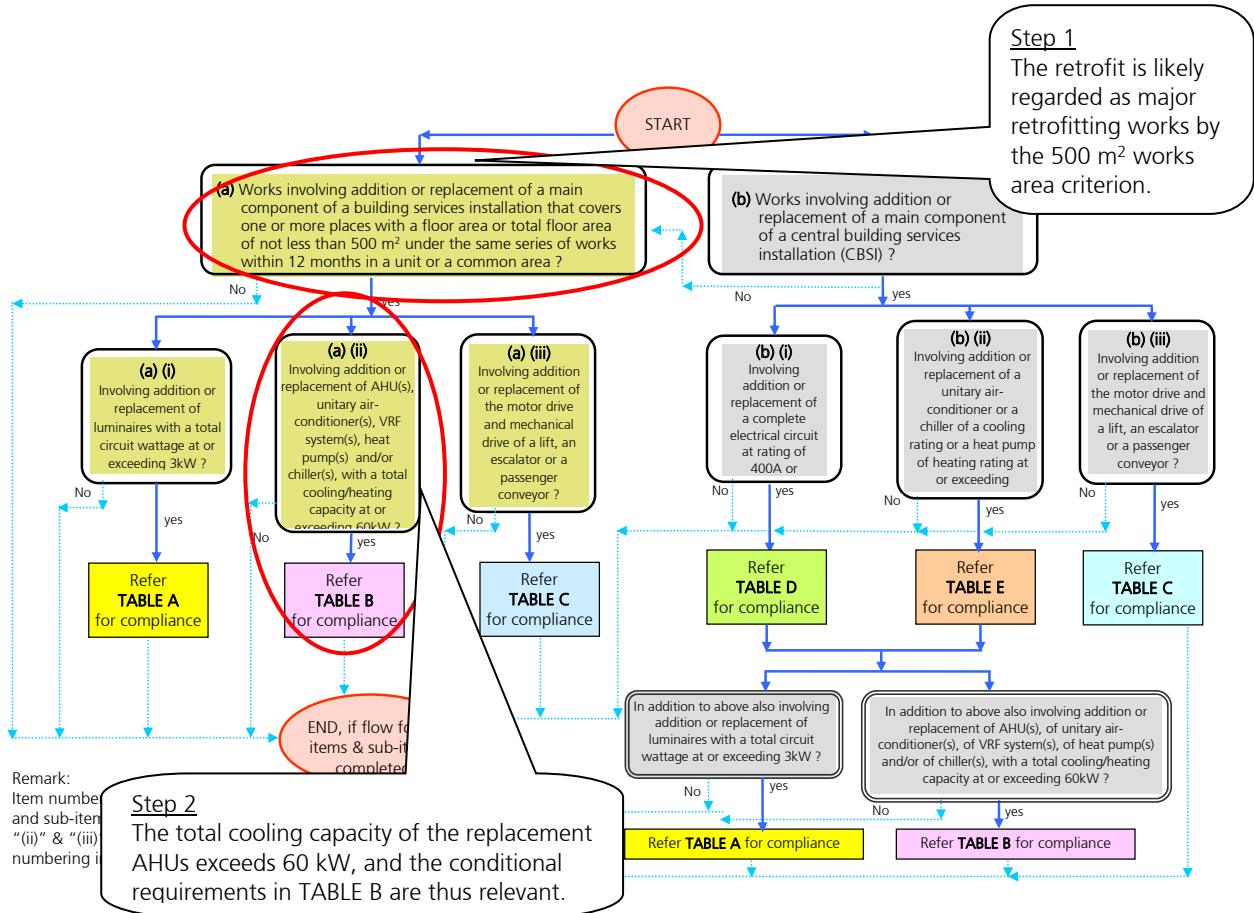


TABLE A		TABLE B		TABLE C		TABLE D		TABLE E	
Condition for Applicability	Applicable BEC Requirement	Condition for Applicability	Applicable BEC Requirement	Condition for Applicability	Applicable BEC Requirement	Condition for Applicability	Applicable BEC Requirement	Condition for Applicability	Applicable BEC Requirement
no existing luminaires in the area, or the sum of circuit wattage of additional or replacement luminaires is more than that of 50% of the original luminaires in the area	lighting power density, BEC clause 5.4	involving addition or replacement of unitary air-conditioner, VRF system, heat pump, cooling tower and/or chiller	air-conditioning equipment efficiency, BEC clause 6.12	the work involving a traction drive lift with machine above and with 1:1 or 2:1 suspension roping system, a hydraulic lift, an escalator or a passenger conveyor	electrical power, BEC clause 8.4	the work involving a complete main circuit, except for cable route between existing transformer room and associated LV switch room with length exceeding 20 m	distribution loss, BEC clause 7.4.2	applicable in any conditions; the work involving addition or replacement of cooling tower	air-conditioning equipment efficiency, BEC clause 6.12
the area has no existing luminaires, or the work involves a complete rewiring of the existing lighting circuits in the area	lighting control point, BEC clause 5.5 Automatic lighting control, BEC clause 5.6	the additional or replacement AHU(s) forming a complete air distribution system in the context of BEC clause 6.7	separate air distribution system for process requirements, BEC clause 6.5 air distribution system fan power, BEC clause 6.7 direct digital control, BEC clause 6.14	the work involving a traction drive lift, a hydraulic lift, an escalator or a passenger conveyor	total power factor, BEC clause 8.5.1 total harmonic distortion, BEC clause 8.6 metering & monitoring facilities, BEC clause 8.7	the work involving a complete feeder	distribution loss, BEC clause 7.4.3	the additional or replacement of air-conditioning equipment involving addition or complete replacement of corresponding water side pumping system	frictional loss of water piping system, BEC clause 6.9 energy metering, BEC clause 6.13 direct digital control, BEC clause 6.14
		the work involving additional water pipework	frictional loss of water piping system, BEC clause 6.9		automatic speed reduction of escalator (except public service escalator and heavy duty escalator, BEC clause 8.5.7)	the work involving a complete sub-circuit	distribution loss, BEC clause 7.4.4	ditto, the corresponding water side pumping system forming an independent system	pumping system variable flow, BEC clause 6.8
		the work involving a complete replacement of corresponding water side pumping system			lift decoration load, BEC clause 8.5.2	the work involving a complete final circuit	distribution loss, BEC clause 7.4.5	the work involving addition or replacement of pipework, ductwork or AHU	thermal insulation, BEC clause 6.11
		the work involving additional or replacement pipework, ductwork or AHU	thermal insulation, BEC clause 6.11	the work involving addition of a lift or replacement of a lift car	lift ventilation & air conditioning, BEC clause 8.5.4	the work involving a main circuit, a feeder or a sub-circuit, with addition of corresponding switch cubicle for the circuit termination at the main LV switchboard	total power factor, BEC clause 7.6.1 total harmonic distortion, BEC clause 7.6.2 balancing of single-phase loads, BEC clause 7.6.3	the work involving addition or replacement of water pump with new motor, or of fan with new motor	motor efficiency, BEC clause 7.5.1
		the work involving addition or replacement of water pump with new motor, of AHU with new motor, or of fan with new motor	motor efficiency, BEC clause 7.5.1		lighting power BEC clause		metering & monitoring facilities, BEC clause 7.7		

**Step 2a**  
The interfacing pipework and ductwork are governed by BEC clause 6.11 in respect of requirements on thermal insulation, and the motors of the AHUs are governed by BEC clause 7.5.1 in respect of motor efficiency.

10.1.4.3 Consider a retrofit involving a replacement of luminaires that covers three places with a total floor area of 550 m<sup>2</sup> under the same series of works within 12 months. The total circuit wattage of the replacement luminaires is 4.5 kW. In replacing the luminaires the existing wiring are reused in Place one and Place three, where in Place two the lighting circuitry to all replacing and remaining luminaires are completely rewired. TG Table 10.1.4.3 below illustrates the checking of the conditions for applicability, for the corresponding energy efficiency requirements in the BEC.

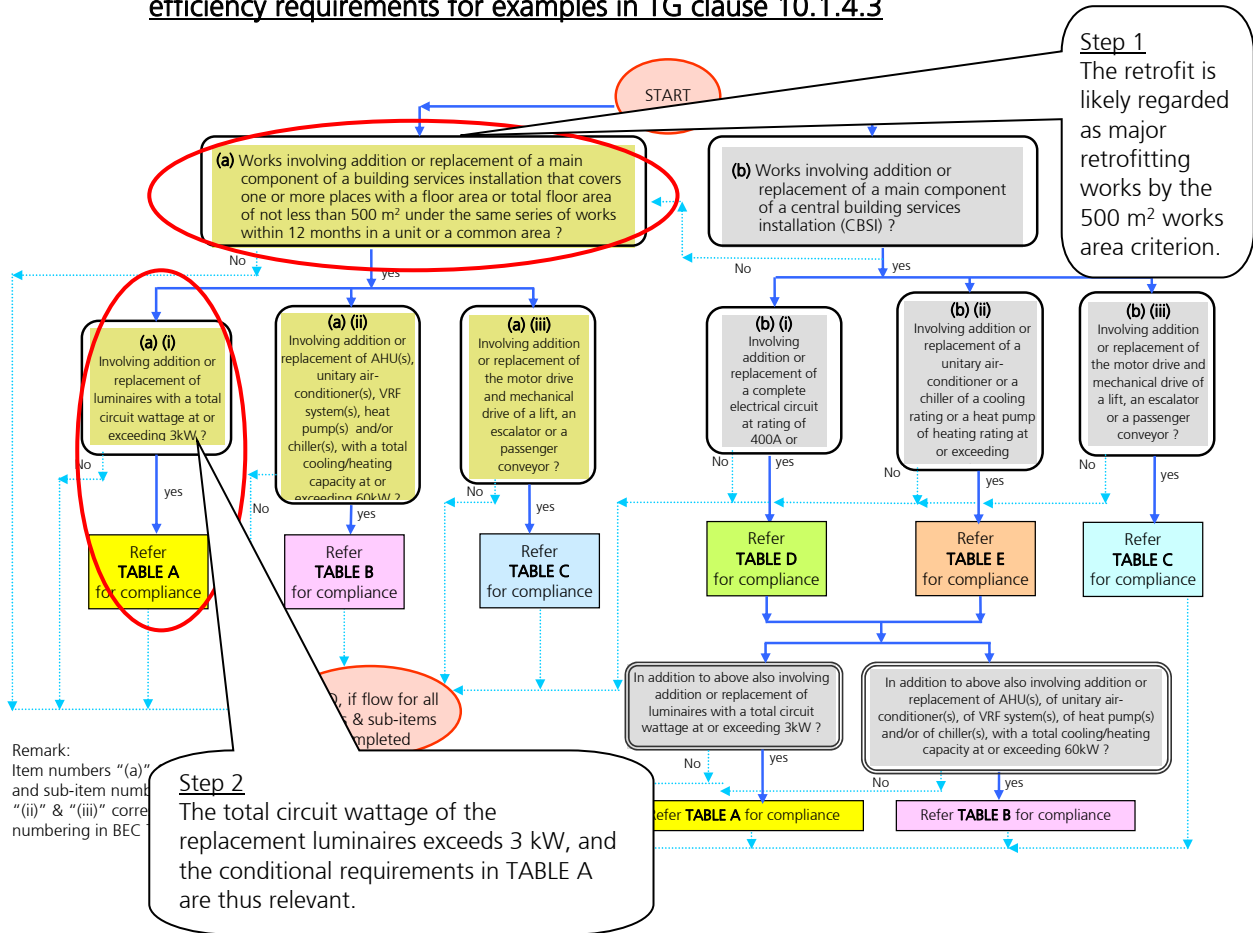
<b>Table 10.1.4.3 : Illustration for a Lighting Retrofit : Checking of Conditions for Applicability, for the Energy Efficiency Requirements</b>				
		<u>Place one</u>	<u>Place two</u>	<u>Place three</u>
<u>Space type</u>		Office 1	Office 2	Corridor (internal corridor connecting Office 1 and Office 2)
<u>Works area (internal floor area)</u>		470 m <sup>2</sup>	50 m <sup>2</sup>	30 m <sup>2</sup>
<u>Original luminaires</u>	<u>Circuit wattage</u>	7.8 kW	0.8 kW	0.36 kW
	<u>50% of above</u>	3.9 kW	0.4 kW	0.18 kW
<u>Circuit wattage of replacement or replacing luminaires</u>		4 kW	0.2 kW	0.3 kW
<u>Checking of Condition for applicability</u>	<u>sub item (a)(i)</u>	Condition fulfilled, total circuit wattage of the works area of the three places is 4.5 kW and exceeds 3 kW		
	<u>TABLE A</u>	<u>LPD requirements in BEC clause 5.4</u>		
		4 kW is greater than 50% of original luminaires circuit wattage i.e. 3.9 kW, hence Place one is governed	0.2 kW is not greater than 50% of original luminaires circuit wattage i.e. 0.4 kW, hence Place two is not governed	0.3 kW is greater than 50% of original luminaires circuit wattage i.e. 0.18 kW, hence Place three is governed
		<u>Lighting control point requirements in BEC clause 5.5</u>		
	Work does not involve a complete rewiring, hence the no. of lighting control point is not governed	Work involves a complete rewiring, hence the no. of lighting control is governed	Lighting control requirement is not applicable to Corridor; also the work does not involve a complete rewiring and hence irrespective of the aforesaid its lighting control is not governed	

		<u>Automatic Lighting control requirements in BEC clause 5.6</u>		
		Work does not involve a complete rewiring, hence the automatic lighting control is not governed	Work involves a complete rewiring, hence the automatic lighting control is governed	Work does not involve a complete rewiring, hence the automatic lighting control is not governed

The retrofit falls within the criteria of major retrofitting works. The process is also shown in TG Figure 10.1.4.3. Having spotted in above table certain BEC non-governed items, to have all the works complying with TG Figure 10.1 TABLE A would be a good engineering practice involving less administrative effort.



Figure 10.1.4.3 : Illustration, against background of TG Figure 10.1, of energy efficiency requirements for examples in TG clause 10.1.4.3



Remark:  
Item numbers "(a)" and sub-item numbers "(i)" & "(iii)" correspond to numbering in BEC

Step 2  
The total circuit wattage of the replacement luminaires exceeds 3 kW, and the conditional requirements in TABLE A are thus relevant.

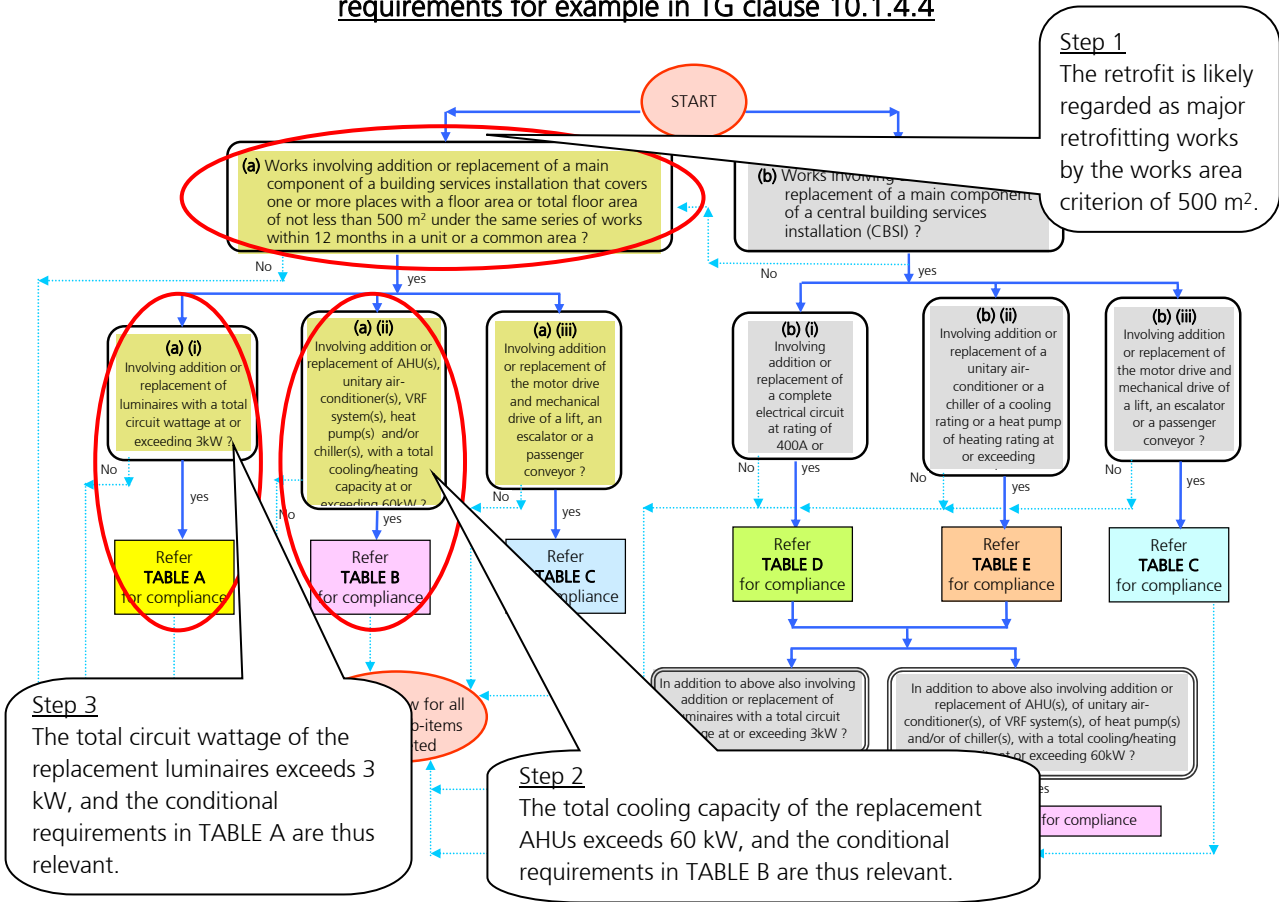
TABLE A		TABLE B		TABLE C		TABLE D		TABLE E	
Condition for Applicability	Applicable BEC Requirement	Condition for Applicability	Applicable BEC Requirement	Condition for Applicability	Applicable BEC Requirement	Condition for Applicability	Applicable BEC Requirement	Condition for Applicability	Applicable BEC Requirement
no existing luminaires in the area, or the sum of circuit wattage of additional or replacement luminaires is more than that of 50% of the original luminaires in the area	lighting power density, BEC clause 5.4	involving addition or replacement of unitary air-conditioner, VRF system, heat pump, cooling tower and/or chiller	air-conditioning equipment efficiency, BEC clause 6.12	the work involving a traction drive lift with machine above and with 1:1 or 2:1 suspension roping system, a hydraulic lift, an escalator or a passenger conveyor	electrical power, BEC clause 8.4	the work involving a complete main circuit, except for cable route between existing transformer room and associated LV switch room with length exceeding 20 m	distribution loss, BEC clause 7.4.2	applicable in any conditions; the work involving addition or replacement of cooling tower	air-conditioning equipment efficiency, BEC clause 6.12
the area has no existing luminaires, or the work involves a complete rewiring of the existing lighting circuits in the area	lighting control point, BEC clause 5.5 Automatic lighting control, BEC clause 5.5	the additional or replacement AHU(s) forming a complete air distribution system in the context of BEC clause 6.7	separate air distribution system for process requirements, BEC clause 6.5 air distribution system fan power, BEC clause 6.7 direct digital control, BEC clause 6.14	the work involving a traction drive lift, a hydraulic lift, an escalator or a passenger conveyor	total power factor, BEC clause 8.5.1 total harmonic distortion, BEC clause 8.6 metering & monitoring facilities, BEC clause 8.7	the work involving a complete feeder	distribution loss, BEC clause 7.4.3	the additional or replacement of air-conditioning equipment involving addition or complete replacement of corresponding water side pumping system	frictional loss of water piping system, BEC clause 6.9 energy metering, BEC clause 6.13 direct digital control, BEC clause 6.14
		the work involving additional water pipework	frictional loss of water piping system, BEC clause 6.9		automatic speed reduction of escalator (except public service escalator and heavy duty escalator, BEC clause 8.5.7)	the work involving a complete feeder, or involving a complete sub-circuit and all its downstream final circuits	total power factor, BEC clause 7.6.1 total harmonic distortion, BEC clause 7.6.2 balancing of single-phase loads, BEC clause 7.6.3	ditto, the corresponding water side pumping system forming an independent system	pumping system variable flow, BEC clause 6.8
		the work involving a complete replacement of corresponding water side pumping system			lift decoration load, BEC clause 8.5.2 lift ventilation & air conditioning, BEC clause 8.5.4	the work involving a main circuit, a feeder or a sub-circuit, with addition of corresponding switch cubicle for the circuit termination at the main LV switchboard	metering & monitoring facilities, BEC clause 7.7	the work involving addition or replacement of pipework, ductwork or AHU	thermal insulation, BEC clause 6.11
		the work involving additional or replacement pipework, ductwork or AHU	thermal insulation, BEC clause 6.11	the work involving addition of a lift or replacement of a lift car	lighting power density, BEC clause 5.4 automatic lighting control, BEC clause 8.5.6			the work involving addition or replacement of water pump with new motor, of AHU with new motor, or of fan with new motor	motor efficiency, BEC clause 7.5.1
		the work involving addition or replacement of water pump with new motor, of AHU with new motor, or of fan with new motor	motor efficiency, BEC clause 7.5.1						

Step 2a  
Please refer to TG Table 10.1.4.3 on illustration of checking for condition of applicability, for corresponding energy efficiency requirements.

- 10.1.4.4 Consider the same retrofit in TG clause 10.1.4.1 above with AHU replacement, but this time the majority of the existing luminaires within the works area are replaced and the replacement luminaires have a total circuit wattage of 5 kW, and in replacing the luminaires the existing wiring to the luminaires are reused. The total circuit wattage of the replaced luminaires was 7 kW. The works area consists of several places accommodating the AHUs and associated replacement pipework and ductwork. The process is shown in TG Figure 10.1.4.4.

In this example, the energy efficiency requirements in TG clause 10.1.4.1 above apply, and in addition as the replacement luminaires have a total circuit wattage fulfilling the condition for applicability of at or exceeding 3 kW (sub-item (a)(i), BEC Table 10.1), the conditions for applicability in TG Figure 10.1 TABLE A are to be further examined. In examining TABLE A, the checking approach in TG Table 10.1.4.3 could be adopted, with identification of the circuit wattages of the original luminaires in each place of the works area. (As TG Table 10.1.4.3 has a good illustration of the approach, information of the circuit wattages in these places are omitted in this example that serves mainly to illustrate the applicability of more than one sub-items, namely (a)(i) and (a)(ii), at the same time.)

Figure 10.1.4.4 : Illustration, against background of TG Figure 10.1, of energy efficiency requirements for example in TG clause 10.1.4.4



**Step 3**  
The total circuit wattage of the replacement luminaires exceeds 3 kW, and the conditional requirements in TABLE A are thus relevant.

**Step 2**  
The total cooling capacity of the replacement AHUs exceeds 60 kW, and the conditional requirements in TABLE B are thus relevant.

**Step 3a**  
A checking of TABLE A is to be carried out for the condition for applicability and the corresponding BEC requirements, for each of the places constituting the works area. The checking approach shown in TG Table 10.1.4.3 could be followed.

**Step 2a**  
The interfacing pipework and ductwork are governed by BEC clause 6.11 in respect of thermal insulation, and the motors of the AHUs are governed by BEC clause 7.5.1 in respect of motor efficiency.

TABLE A		TABLE B		TABLE C		TABLE D		TABLE E	
Condition for Applicability	Applicable BEC Requirement	Condition for Applicability	Applicable BEC Requirement	Condition for Applicability	Applicable BEC Requirement	Condition for Applicability	Applicable BEC Requirement	Condition for Applicability	Applicable BEC Requirement
no existing luminaires in the area, or the sum of circuit wattage of additional or replacement luminaires is more than that of 50% of the original luminaires in the area	lighting power density, BEC clause 5.4	involving addition or replacement of unitary air-conditioner, VRF system, heat pump, cooling tower and/or chiller	air-conditioning equipment efficiency, BEC clause 6.12	the work involving a traction drive lift with machine above and with 1:1 or 2:1 suspension roping system, a hydraulic lift, an escalator or a passenger conveyor	electrical power, BEC clause 8.4	the work involving a complete main circuit, except for cable route between existing transformer room and associated LV switch room with length exceeding 20 m	distribution loss, BEC clause 7.4.2	applicable in any conditions; the work involving addition or replacement of cooling tower	air-conditioning equipment efficiency, BEC clause 6.12
the area has no existing luminaires, or the work involves a complete rewiring of the existing lighting circuits in the area	lighting control point, BEC clause 5.5 Automatic lighting control, BEC clause 5.6	the additional or replacement AHU(s) forming a complete air distribution system in the context of BEC clause 6.7	separate air distribution system for process requirements, BEC clause 6.5 air distribution system fan power, BEC clause 6.7 direct digital control, BEC clause 6.14	the work involving a traction drive lift, a hydraulic lift, an escalator or a passenger conveyor	total power factor, BEC clause 8.5.1 total harmonic distortion, BEC clause 8.6 metering & monitoring facilities, BEC clause 8.7 automatic speed reduction of escalator (except public service escalator and heavy duty escalator, BEC clause 8.5.7)	the work involving a complete feeder	distribution loss, BEC clause 7.4.3	the additional or replacement of air-conditioning equipment involving addition or complete replacement of corresponding water side pumping system	frictional loss of water piping system, BEC clause 6.9 energy metering, BEC clause 6.13 direct digital control, BEC clause 6.14
		the work involving additional water pipework	frictional loss of water piping system, BEC clause 6.9			the work involving a complete sub-circuit	distribution loss, BEC clause 7.4.4	ditto, the corresponding water side pumping system forming an independent system	pumping system variable flow, BEC clause 6.8
		the work involving a complete replacement of corresponding water side pumping system				the work involving a complete final circuit	distribution loss, BEC clause 7.4.5	the work involving addition or replacement of pipework, ductwork or AHU	thermal insulation, BEC clause 6.11
		the work involving additional or replacement pipework, ductwork or AHU	thermal insulation, BEC clause 6.11	the work involving addition of a lift or the replacement of a lift car	lift decoration load, BEC clause 8.5.2 lift ventilation & air	the work involving a main circuit, a feeder or a sub-circuit, with addition of corresponding switch cubicle for the circuit, termination at the main LV switchboard	total power factor, BEC clause 7.6.1 total harmonic distortion, BEC clause 7.6.2 balancing of single-phase loads, BEC clause 7.6.3 metering & monitoring facilities, BEC clause 7.7	the work involving addition or replacement of water pump with	motor efficiency, BEC clause 7.5.1

#### 10.1.5 Examples of Major Retrofitting Works by Virtue of Fulfilling the Main CBSI Component Criterion

Examples of work items are given in TG clauses 10.1.5.1 to 10.1.5.3.

- 10.1.5.1 Consider a retrofit involving the replacement of a chiller of 400 kW cooling capacity. The retrofit also includes the replacement of the chilled water pump (with reuse of existing pump motor) serving the chiller, the replacement of a number of AHUs with total cooling capacity at 100 kW. For one of the AHUs namely AHU1, all the ductwork of the air distribution system are also replaced; AHU1 is the only AHU in the air distribution system. For each of the other AHUs, there are no changes to the existing ductwork, except at the interfacing with the new AHU where certain modification works are required to facilitate the replacement. For the chiller, the chilled water pump and all the AHUs, there are no changes to the existing pipework and electrical circuitries, except at the interface with the new equipment where certain modification works are required to facilitate the replacement. The retrofit also includes the replacement of the luminaires in the central chilled water plant room and AHU rooms, and the total circuit wattage of the replacement luminaires is 3.5 kW. The process is shown in TG Figure 10.1.5.1, in which the reader can also easily identify the applicable energy efficiency requirements based on the approaches introduced in the earlier examples in TG clause 10.1.4.

Figure 10.1.5.1 : Illustration, against background of TG Figure 10.1, of energy efficiency requirements for example in TG clause 10.1.5.1

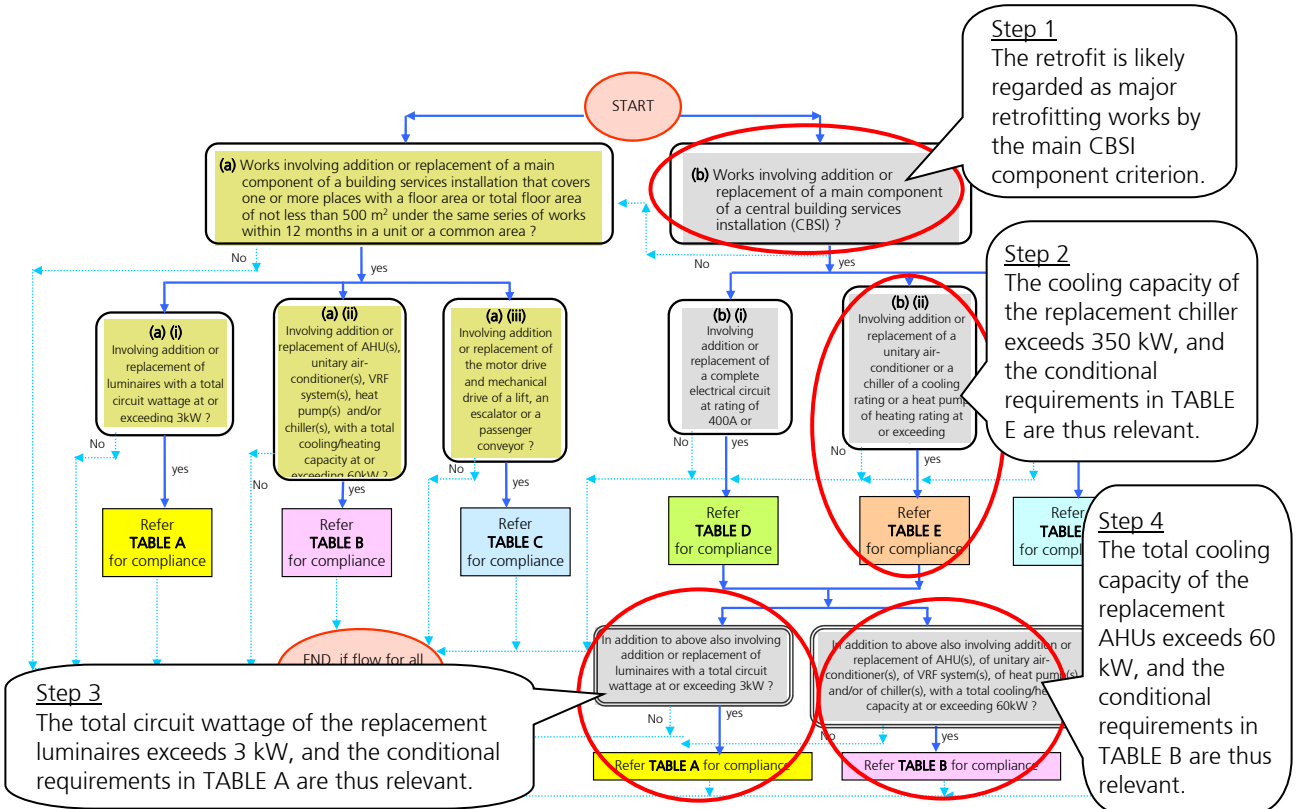


TABLE A		TABLE B		TABLE C		TABLE D		TABLE E	
Condition for Applicability	Applicable BEC Requirement	Condition for Applicability	Applicable BEC Requirement	Condition for Applicability	Applicable BEC Requirement	Condition for Applicability	Applicable BEC Requirement	Condition for Applicability	Applicable BEC Requirement
no existing luminaires in the area, or the sum of circuit wattage of additional or replacement luminaires is more than that of 50% of the original luminaires in the area	lighting power density, BEC clause 5.4	involving addition or replacement of unitary air-conditioner, VRF system, heat pump, cooling tower and/or chiller	air-conditioning equipment efficiency, BEC clause 6.12	the work involving a traction drive lift with machine above and with 1:1 or 2:1 suspension roping system, a hydraulic lift, an escalator or a passenger conveyor	electrical power, BEC clause 8.4	the work involving a complete main circuit, except for cable route between existing transformer room and associated LV switch room with length exceeding 20 m	distribution loss, BEC clause 7.4.2	applicable in any conditions; the work involving addition or replacement of cooling tower	air-conditioning equipment efficiency, BEC clause 6.12
the area has no existing luminaires, or the work involves a complete rewiring of the existing lighting circuits in the area	lighting control point, BEC clause 5.5 Automatic lighting control, BEC clause 5.6	the additional or replacement AHU(s) forming a complete air distribution system in the context of BEC clause 6.7	separate air distribution system for process requirements, BEC clause 6.5 air distribution system fan power, BEC clause 6.7	the work involving a traction drive lift, a hydraulic lift, an escalator or a passenger conveyor	total power factor, BEC clause 8.5.1 total harmonic distortion, BEC clause 8.6 metering & monitoring facilities, BEC clause 8.7	the work involving a complete feeder	distribution loss, BEC clause 7.4.3 distribution loss, BEC clause 7.4.4 distribution loss, BEC clause 7.4.5	the additional or replacement of air-conditioning equipment involving addition or complete replacement of corresponding water side pumping system	frictional loss of water piping system, BEC clause 6.9 energy metering, BEC clause 6.13 direct digital control, BEC clause 6.14
		the work involving additional water pipework	frictional loss of water piping system, BEC clause 6.9	the work involving addition of a lift or replacement of a lift car	automatic speed reduction of escalator (except public service escalator and heavy duty escalator, BEC clause 8.5.7) lift decoration load, BEC clause 8.5.2 lift ventilation & air conditioning, BEC clause 8.5.4 lighting power density, BEC clause 5.4 automatic lighting	the work involving a complete sub-circuit and all its downstream final circuits	total power factor, BEC clause 7.6.1 total harmonic distortion, BEC clause 7.6.2 balancing of single-phase loads, BEC clause 7.6.3	ditto, the corresponding water side pumping system forming an independent system	pumping system variable flow, BEC clause 6.8
		the work involving replacement of water piping system	thermal insulation, BEC clause 6.11 motor efficiency, BEC clause 7.5.1			the work involving a feeder or a sub-circuit, with addition of corresponding switch cubicle for the circuit termination at the main LV switchboard	metering & monitoring facilities, BEC clause 7.7	the work involving addition or replacement of pipework, ductwork or AHU	thermal insulation, BEC clause 6.11
								the work involving addition or replacement of water pump with new motor, or of fan with new motor	motor efficiency, BEC clause 7.5.1

**Step 3a**  
A checking of TABLE A is to be carried out, for the condition for applicability and the corresponding BEC requirements, for each of the places constituting the works area. The checking approach shown in TG Table 10.1.4.3 could be followed.

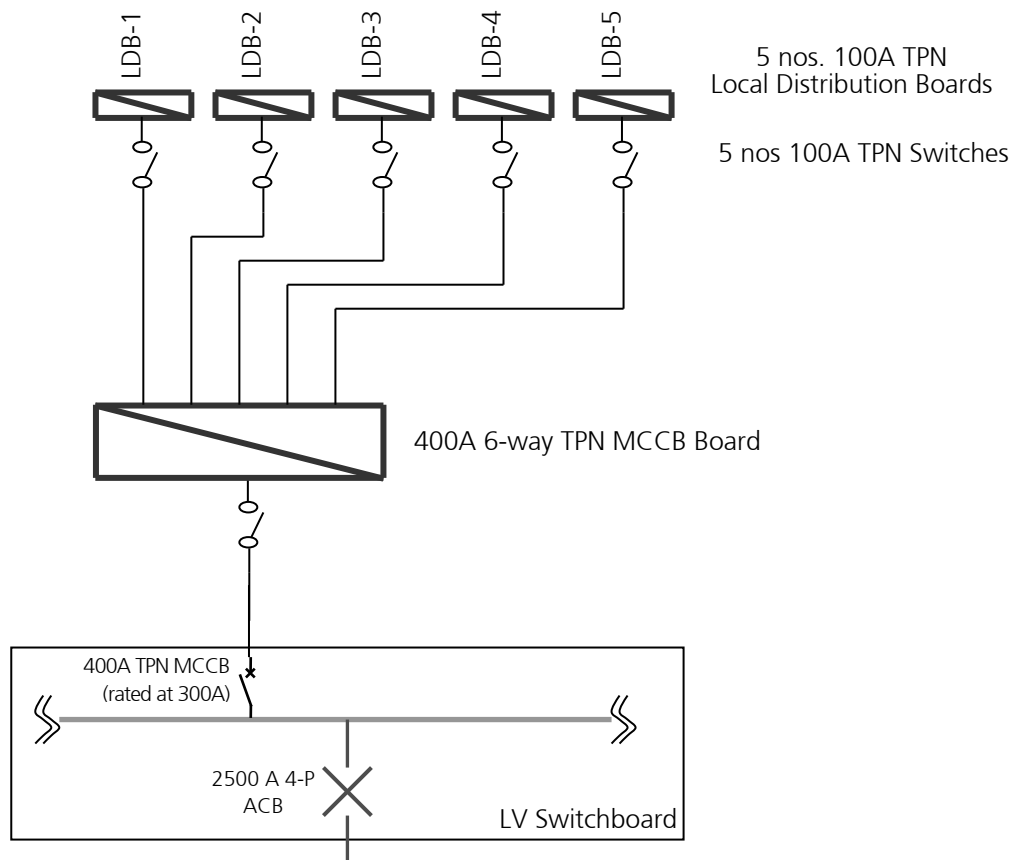
**Step 4a**  
AHU1 is governed by BEC clause 6.7 in respect of air distribution system fan power.

**Step 2a**  
The replacement chiller is governed by the COP requirements in BEC clause 6.12.

**Step 2b**  
The interfacing pipework and ductwork are governed by BEC clause 6.11 in respect of thermal insulation, and the motors of the AHUs are governed by BEC clause 7.5.1 in respect of motor efficiency.

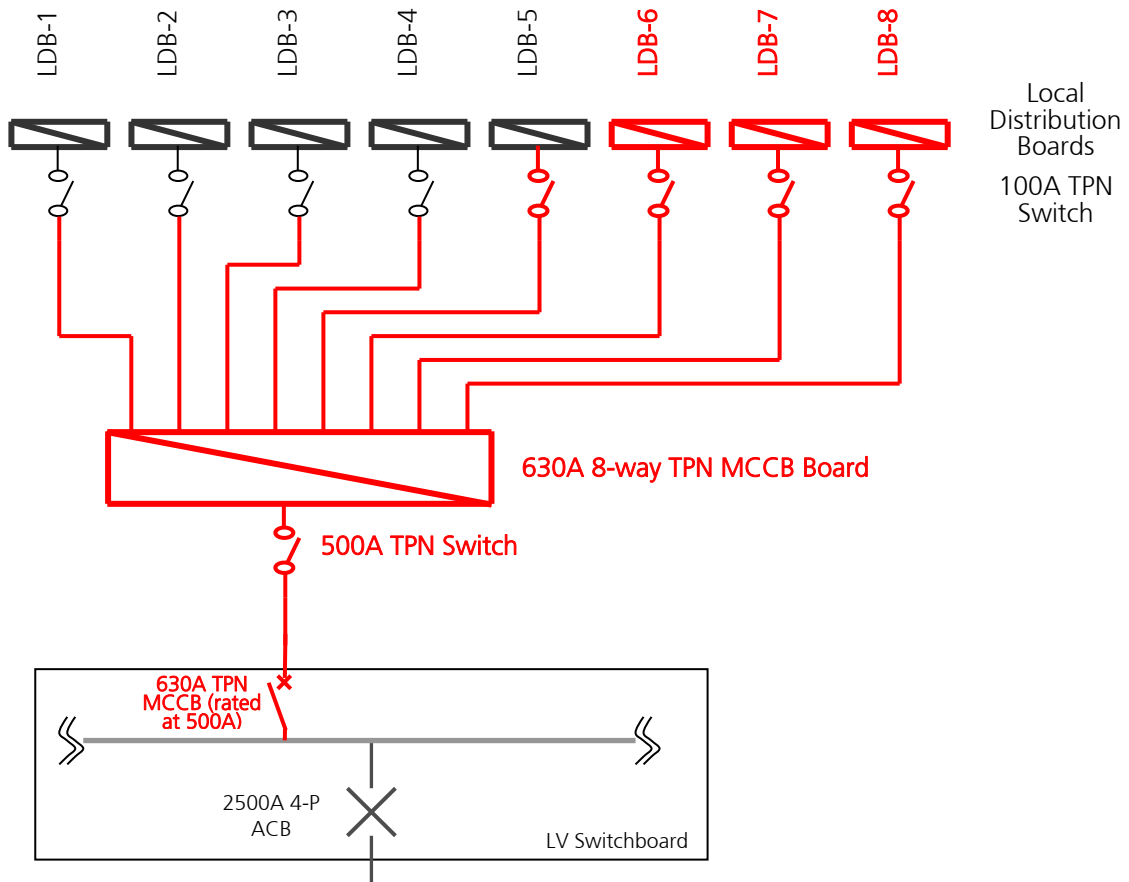
10.1.5.2 Consider a retrofit involving the addition of distribution boards and modification of a CBSI electrical circuit. The existing circuitry is indicated in TG Figure 10.1.5.2 (a), in which is shown an outgoing circuit from the main LV switchboard via a 300A TPN MCCB to a 400A 6-way TPN MCCB board feeding 5 nos. CBSI local distribution boards LDB-1 to LDB-5. The retrofit also includes the replacement of certain luminaires in the plant rooms, lift lobbies and corridors, and the total wattage of the replacement luminaires is 4 kW.

**Figure 10.1.5.2 (a) : Schematic wiring diagram, existing**



In the retrofit, the circuit is to provide electrical supply to three more local distribution boards. The existing 400A MCCB (rated at 300A) in the main LV switchboard is to be replaced with a 630A MCCB (rated at 500A), and the existing 400A 6-way TPN MCCB board to be replaced with a 630A 8-way TPN MCCB board. 3 nos. new local distribution boards LDB-6 to LDB-8 are to be added. All the existing interconnecting cabling are to be replaced, and in addition for LDB-5 the 100A TPN switch is to be replaced too. The new electrical supply circuitry after the retrofit is shown in TG Figure 10.1.5.2 (b), with the new and replacement items indicated in red colour.

**Figure 10.1.5.2 (b) : Schematic wiring diagram of retrofit**



Complete 400A Sub-circuit

The process in considering whether the retrofit is major retrofitting works is shown in TG Figure 10.1.5.2 (c). The retrofit falls within the scope of major retrofitting works by virtue of fulfilling the CBSI main component criterion – addition or replacement of complete circuit at 400A. The 400A is based on the rating of the circuit protective device; if the 400 A MCCB is rated down say to 300A the circuit is not at 400A and would not be considered as major retrofitting works.

Attention is drawn that should the retrofit not involve the replacement of the existing 400A TPN MCCB (rated at 300A) in the LV switchboard with the replacing 630A TPN MCCB (rated at 500A), the sub-circuitry would not be a complete circuit. To be considered as a complete sub-circuit, the replacement or addition of a MCCB, fuse or switch at the LV switchboard should be involved. Likewise if one of the circuit portions from the 630A MCCB board to any one of LDB-1 to LDB-5 not be replaced, the retrofit would not be considered as a complete sub-circuit. On the other hand, the addition or replacement of local distribution board(s) is not a must in the consideration of a complete sub-circuit, and if the retrofit above does not involve the addition of LDB-6 to LDB-8 the sub-circuitry is still considered as a complete circuit. It is only the retrofit involves a complete circuit, addition or replacement, at or above 400A that it would be considered as major retrofitting works.

Figure 10.1.5.2 (c) : Illustration, against background of TG Figure 10.1, of energy efficiency requirements for example in TG clause 10.1.5.2

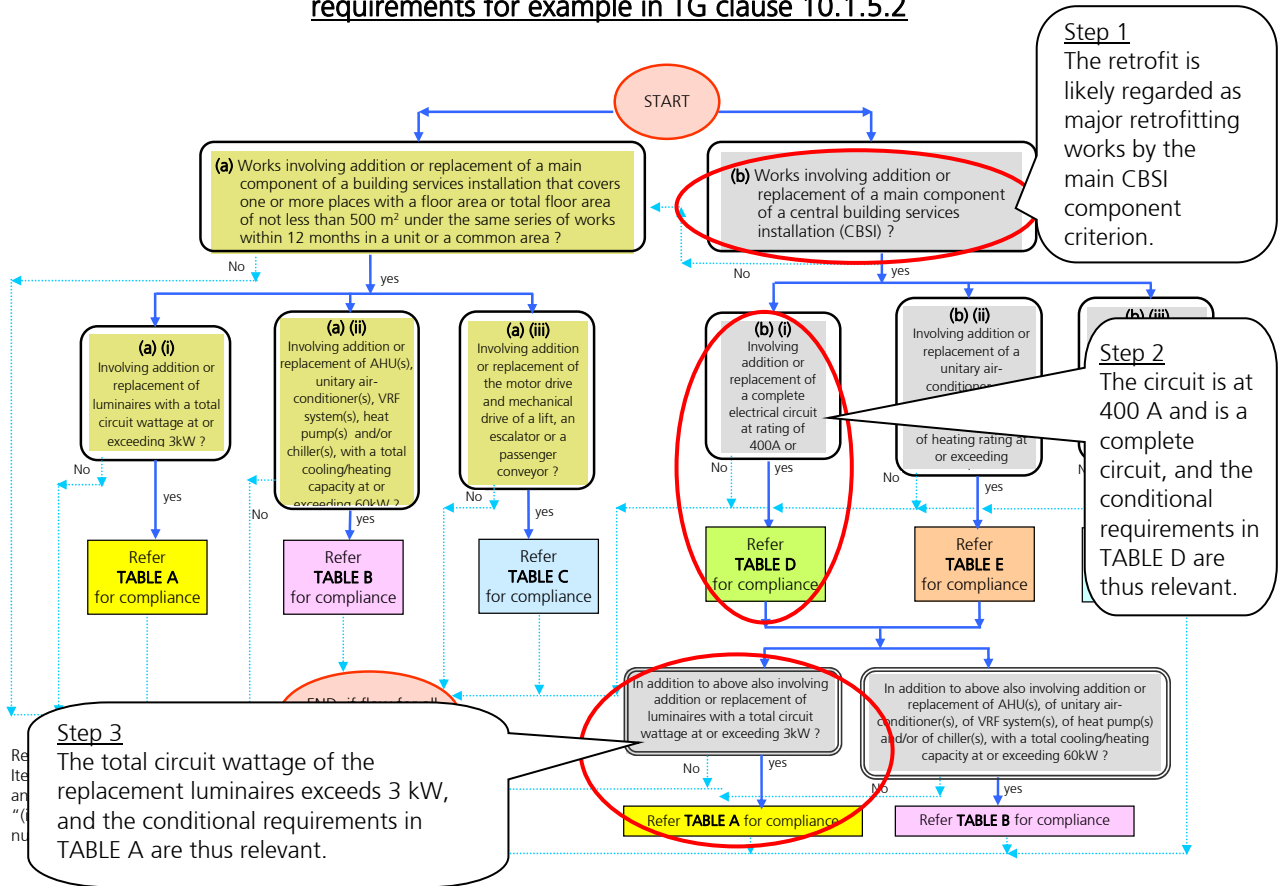


TABLE A		TABLE B		TABLE C		TABLE D		TABLE E	
Condition for Applicability	Applicable BEC Requirement	Condition for Applicability	Applicable BEC Requirement	Condition for Applicability	Applicable BEC Requirement	Condition for Applicability	Applicable BEC Requirement	Condition for Applicability	Applicable BEC Requirement
no existing luminaires in the area, or the sum of circuit wattage of additional or replacement luminaires is more than that of 50% of the original luminaires in the area	lighting power density, BEC clause 5.4	involving addition or replacement of unitary air-conditioner, VRF system, heat pump, cooling tower and/or chiller	air-conditioning equipment efficiency, BEC clause 6.12	the work involving a traction drive lift with machine above and with 1:1 or 2:1 suspension roping system, a hydraulic lift, an escalator or a passenger conveyor	electrical power, BEC clause 8.4	the work involving a complete main circuit, except for cable route between existing transformer room and associated LV switch room with length exceeding 20 m	distribution loss, BEC clause 7.4.2	applicable in any conditions; the work involving addition or replacement of cooling tower	air-conditioning equipment efficiency, BEC clause 6.12
the area has no existing luminaires, or the work involves a complete rewiring of the existing lighting circuits in the area	lighting control point, BEC clause 5.5 Automatic lighting control, BEC clause 5.6	the additional or replacement AHU(s) forming a complete air distribution system in the context of BEC clause 6.7	separate air distribution system for process requirements, BEC clause 6.5	the work involving a traction drive lift, a hydraulic lift, an escalator or a passenger conveyor	total power factor, BEC clause 8.5.1	the work involving a complete feeder	distribution loss, BEC clause 7.4.3	the additional or replacement of air-conditioning equipment involving addition or complete replacement of corresponding water side pumping system	frictional loss of water piping system, BEC clause 6.9
			air distribution system fan power, BEC clause 6.7		total harmonic distortion, BEC clause 8.6	the work involving a complete sub-circuit	distribution loss, BEC clause 7.4.4		energy metering, BEC clause 6.13
		the work involving additional water pipework	frictional loss of water piping system, BEC clause 6.9		metering & monitoring facilities, BEC clause 8.7	the work involving a complete final circuit	distribution loss, BEC clause 7.4.5		direct digital control, BEC clause 6.14
		the work involving a complete replacement of corresponding water side pumping system			automatic speed reduction of escalator (in public sector) or escalator duty, BEC clause 8.8	the work involving a complete feeder, or involving a complete sub-circuit and all its downstream final circuits	total power factor, BEC clause 7.6.1		pumping system variable flow, BEC clause 6.8
		the work involving additional or replacement pipework	thermal insulation, BEC clause 6.11	the work involving addition of a lift or replacement of a lift	lift, BEC clause 8.9		total harmonic distortion, BEC clause 7.6.2		
							balancing of single-phase loads, BEC clause 7.6.3		
							metering & monitoring facilities, BEC clause 7.7		
								ditto, the corresponding water side pumping system forming an independent system	
								the work involving addition or replacement of pipework, ductwork or AHU	thermal insulation, BEC clause 6.11
								the work involving addition or replacement of water pump with new motor, or of fan with new motor	motor efficiency, BEC clause 7.5.1

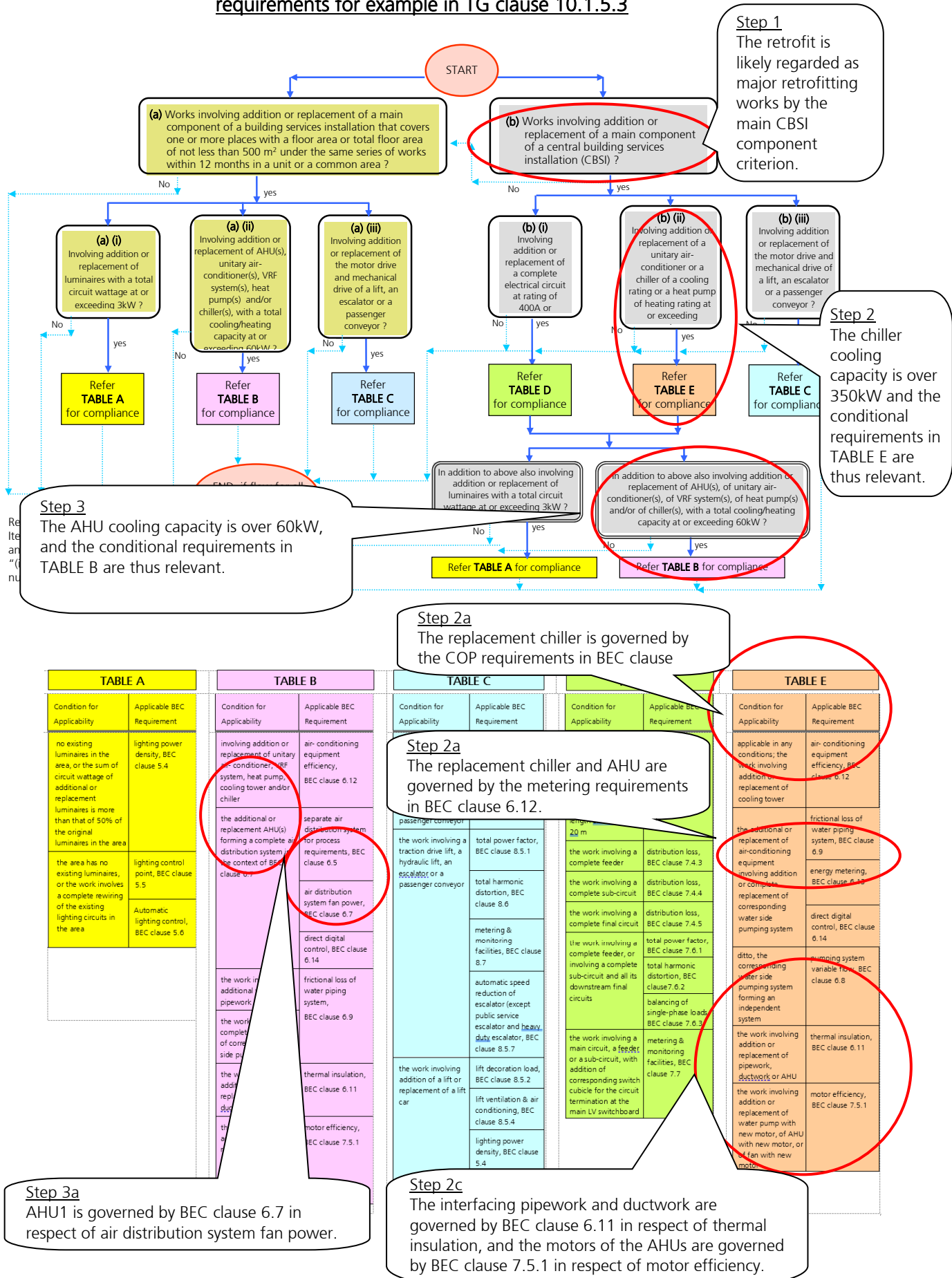
**Step 3a**  
A checking of TABLE A is to be carried out, for the condition for applicability and the corresponding BEC requirements, for each of the places constituting the works area. The checking approach shown in TG Table 10.1.3.2 could be followed.

**Step 2a**  
The 8 nos circuits from the 630A MCCB to the LDBs are governed, in respect of maximum allowable copper loss, by BEC clause 7.4.4. The 3 nos final circuits from LDBs 6, 7 & 8 are also governed, in respect of maximum allowable copper loss, by BEC clause 7.4.5; nevertheless should there be no circuits over 32A there is no actual requirement.



- 10.1.5.3 Consider a retrofit involving the replacement of a chiller of 400 kW cooling capacity. The retrofit also includes the replacement of an AHU with total cooling capacity at 80 kW. For the AHU, there are no changes to the existing ductwork, except at the interfacing with the new AHU where certain modification works are required to facilitate the replacement. The retrofit is regarded as major retrofitting works as the chiller of over 350kW cooling capacity is being replaced. The AHU should also be regarded as part of the major retrofitting works even though the involved works area is less than 500m<sup>2</sup>. The process is shown in TG Figure 10.1.5.3.

Figure 10.1.5.3 : Illustration, against background of TG Figure 10.1, of energy efficiency requirements for example in TG clause 10.1.5.3



10.1.6 Major Retrofitting Works Fulfilling Both Works Area Criterion and Main CBSI Component Criterion

For retrofitting works fulfilling both criteria, the following of the work flow in examples in TG clause 10.1.5 for the main CBSI component criterion would suffice, given such having included the checking for the applicable requirements based on luminaires circuit wattage (Table A in TG Figure 10.1), capacity of AHU/chiller / heat pump / cooling tower / VRF system / unitary air-conditioner (Table B in TG Figure 10.1), and capacity of lift/escalator (Table C in TG Figure 10.1).

10.1.7 Same Series of Works in 12-month

BEC Table 10.1 Remark 4 gives certain guidance on –

- the “same series of works”, and
- the “same series of works within 12-month” concept, which is more precisely the 500 m<sup>2</sup> counting period.

BEC Table 10.1 Remark 4 is extracted in TG Table 10.1.7 (a) below for ready reference.

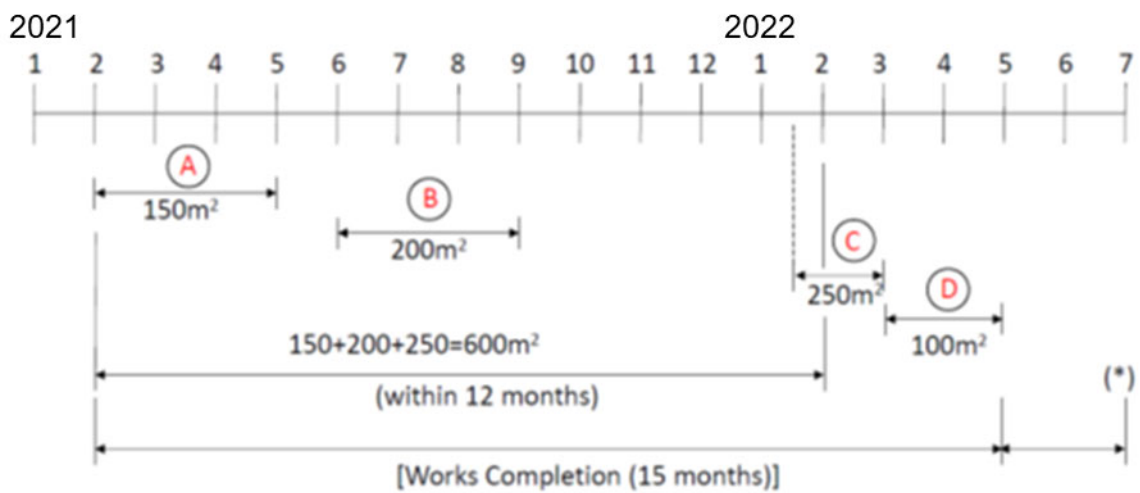
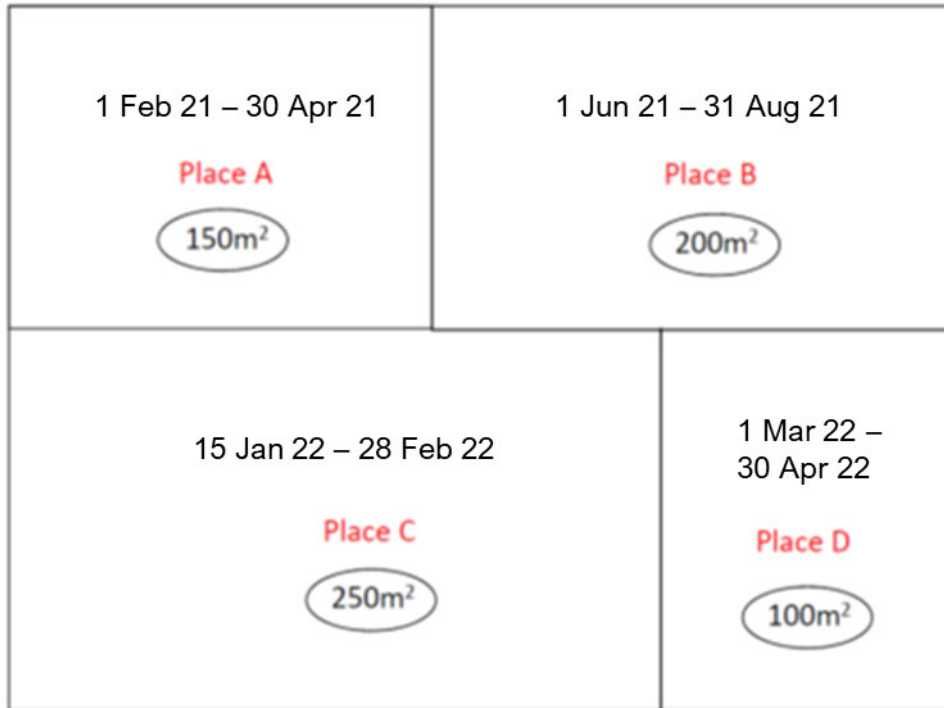
<b>Table 10.1.7 (a) : Extract of BEC Table 10.1 Remark 4</b>
<p>The “12-month” period under a same series of works specified in item (a) of this table may be counted from the commencement date of either one of the works under the same series of works.</p> <p>The floor area covered by any works of the same series of works commenced within this 12-month period (the first day and the last day inclusive) should be counted towards the “total floor area” covered by the same series of works within this 12-month period.</p> <p>If some works under the same series of works have commenced within a 12-month period in a unit or a common area and their works areas aggregate to not less than 500 m<sup>2</sup>, then besides these works all other works of the same series of works in the same unit or common area, even not commenced within the said 12-month period, should also comply with requirements specified above for item (a).</p>

Consider a series of works involving four places namely A, B, C & D each having working period and space area shown below. Two cases namely Case I and Case II (for these four places) in corresponding TG Tables 10.1.7 (b) & (c) below illustrate the approaches to determine, with reference to BEC Table 10.1 Remark 4, if the works fall within the scope of major retrofitting works. Case II in particular gives the guideline in

respect of work items having an overall working period exceeding the 12-month period which may not necessarily covers all the work items; the guideline is, in the assigning of work items for the 12-month or more precisely the 500 m<sup>2</sup> counting period, to accord the priority to those larger area places (amidst all places) that more readily aggregate to the 500 m<sup>2</sup> criterion.

<b>Table 10.1.7 (b) : Retrofitting Works Case I</b>				
<u>Place</u>	<u>Working period</u>	<u>Works internal floor area</u>	<u>Remarks on same series of works in a 12-month period</u>	<u>Form of Compliance (FOC)</u>
A	1 Feb – 30 Apr 2021	150 m <sup>2</sup>	500 m <sup>2</sup> counting period (max 12-month) starts on 1 Feb 2021 and ends on 31 Jan 2022.  Works area within this 500 m <sup>2</sup> counting period is thus 150m <sup>2</sup> + 200m <sup>2</sup> + 250m <sup>2</sup> = 600 m <sup>2</sup> .  500 m <sup>2</sup> works area criterion of major retrofitting works is fulfilled for works in places A to C, which are thus governed by BEC Table 10.1 item (a).	The works in all places A to D should be covered by <b>one</b> FOC. The FOC should be obtained within 2 months after the completion of the Works.
B	1 Jun – 31 Aug 2021	200 m <sup>2</sup>		
C	15 Jan – 28 Feb 2022	250 m <sup>2</sup>		
D	1 Mar – 30 Apr 2022	100 m <sup>2</sup>	As works in place D together with works in places A to C form the same series of work, even the works program of places A to D spread through a duration exceeding 12 months, BEC Table 10.1 item (a) also governs works in place D.	

Figure 10.1.7 (b) : Illustration of Retrofitting Works Case I

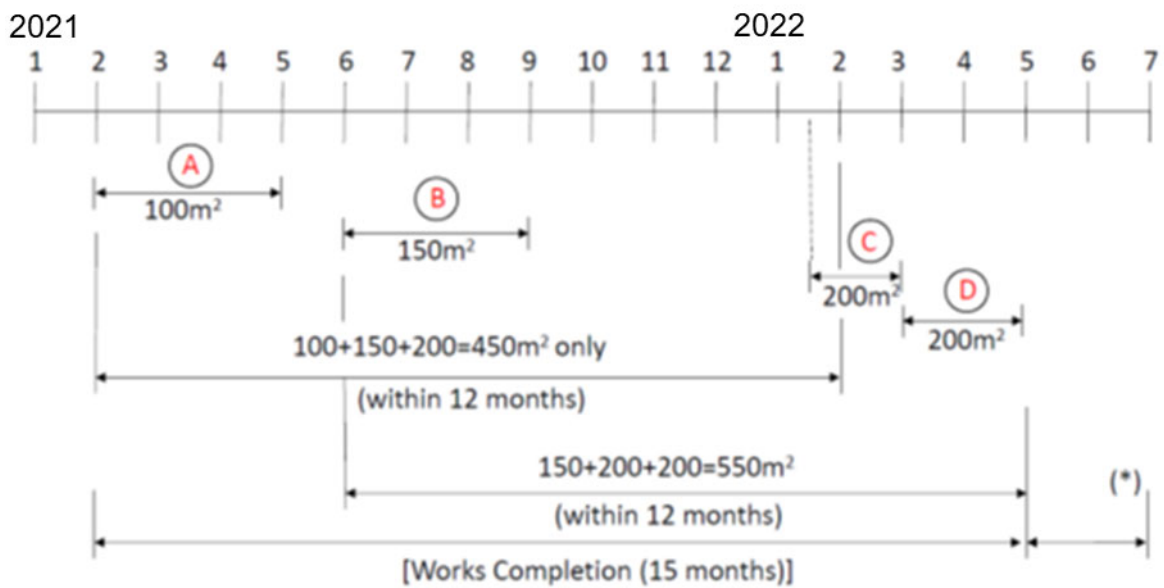


Works in (A), (B), (C) and (D) are same series of works, thus the Works are MRWs as a whole with works program of 15 months

⇒ (\*) one FOC within 2 months after completion shall be obtained

<b>Table 10.1.7 (c) : Retrofitting Works Case II</b>				
<u>Place</u>	<u>Working period</u>	<u>Works internal floor area</u>	<u>Remarks on same series of works in a 12-month period</u>	<u>Form of Compliance (FOC)</u>
A	1 Feb – 30 Apr 2021	100 m <sup>2</sup>	<p>The earliest date of the corresponding places' working period commencement dates should not always be taken as the start of the 500 m<sup>2</sup> counting period (max 12-month) in the counting of the aggregate floor area towards the 500 m<sup>2</sup> criterion. In Case II here, the working period commencement date of 1 Jun 2021 of place B should be taken as the start date, as the aggregate of place B and those places with works that follow more readily add up to over 500 m<sup>2</sup> (150m<sup>2</sup> (B) + 200m<sup>2</sup> (C) + 200m<sup>2</sup> (D) = 550 m<sup>2</sup>). BEC Table 10.1 item (a) governs these places. (Here the 500 m<sup>2</sup> counting period starts on 1 Jun 2021 and ends on 30 Apr 2022.)</p> <p>Reverting to place A, as it together with places B to D form the series of work, hence even the works program of places A to D spread through a duration exceeding 12 months, BEC Table 10.1 item (a) also governs works in place A.</p> <p>It may be that when the series of works starts (i.e. as at 1 Feb 2021), the works areas of places B to D are yet to be confirmed. Under the situation it is better to have the relevant building services installation in place A to comply with the relevant requirements in BEC Table 10.1 item (a), to avoid the possible non-compliance that can only be known upon confirmation of the works areas.</p>	<p>The works in all places A to D should be covered by <b>one</b> FOC. The FOC should be obtained within 2 months after the completion of the Works.</p>
B	1 Jun – 31 Aug 2021	150 m <sup>2</sup>		
C	15 Jan – 28 Feb 2022	200 m <sup>2</sup>		
D	1 Mar – 30 Apr 2022	200 m <sup>2</sup>		

Figure 10.1.7 (c) : Illustration of Retrofitting Works Case II



Works in (A),(B),(C) and (D) are same series of works, thus the Works are MRWs as a whole with works program of 15 months

⇒ (\*) one FOC within 2 months after completion shall be obtained

#### 10.1.8 Retrofitting Works Involving Luminaires Left Ready by Developer / Building Owner


Any luminaires provided and fixed in position by the developer or building owner might not be regarded as the existing luminaires. As such the tenant conducting retrofitting works including the wiring-only works might still have to comply with the BEC requirements in respect of lighting power density (LPD), lighting control point (LCP) and automatic lighting control (ALC) depending on the various circumstances as discussed below.


- (a) Works conducted by the developer of a new building: When the developer considers that the future tenant may fully re-use those luminaires fixed in position (hung with stay wires from ceiling slab and lined up with false ceiling grids) in a unit (e.g. office) without any changes, the developer is advised to include the works in the stage two declaration as part of the works completed by the developer. In the stage two declaration, the developer should demonstrate that those luminaires left ready are so selected, designed and layout in compliance with the relevant BEC edition in respect of LPD requirement.
- (b) Works conducted by the building owner of an existing building: Likewise to (a), in case the building owner expects the luminaires provided and fixed in position (such as hung with stay wires from ceiling slab and lined up with false ceiling grids) in the unit (e.g. office) to be fully re-use by the future tenant without layout change, the building owner is advised to include the works under the FOC and demonstrate the compliance with LPD requirement to the relevant BEC edition.
- (c) Wiring-only works might not be regarded as “major retrofitting works”: Presume that a tenant moves in a new office having luminaires left ready by the developer or building owner with the design and layout complying with the BEC. If the tenant retains all the existing luminaires i.e. not involve any change in layout or relocation on those luminaires provided and fixed in position by the developer/building owner, and his/her retrofitting works only involve the inter-connecting power supply/control wiring, his/her such wiring-only works are not regarded as “major retrofitting works”.
- (d) Compliance with the requirements on lighting control point (LCP) and automatic lighting control (ALC) are elaborated on the following paragraphs with the aids from TG Table 10.1.8 (1) and TG Table 10.1.8 (2).


*TG Table 10.1.8 (1) illustrates the case where the luminaires left ready **are covered** by a stage two declaration or FOC undertaken by the developer or building owner previously. This serves as the further elaboration of the discussion in item (a) to (c) above.*



*TG Table 10.1.8 (2) illustrates that the luminaires left ready, when **not covered** by any previous stage two declaration or FOC, are not regarded as the existing installation. The new tenant may need to take up the scope on compliance with the BEC requirements as illustrated.*

*In both the TG Tables, cells marked in  stands for the remarks in relation to the works conducted by the developer or the building owner.*

*Cells marked in  stands for the remarks to tenant's scope/liability when the works involved not fulfilling major retrofitting works criteria.*

*Likewise, cells marked in  stands for the remarks to tenant's scope/liability when the works involved fulfilling the criteria of major retrofitting works (MRW).*

- (e) TG Table 10.1.8 (1) – Developer/Building Owner provides and fixed luminaires with design LPD in compliance with the BEC:

Presume that the developer/building owner demonstrates BEC compliance (in respect of LPD) by conducting the relevant submission before the full implementation date of the BEC 2021, i.e. before 1 October 2022, for those luminaires provided and fixed inside the tenant space. In each of the case, the developer/building owner demonstrates only LPD compliance through proper lamp source and luminaire selection and design layout.

In (A), the developer includes the works under a stage 2 declaration to BEC 2012 or BEC 2012 (Rev. 1) or BEC 2015 or BEC 2018 while the building is subsequently granted with a COCR to the relevant BEC edition. In (B), the building owner includes also the works inside the building units under a FOC to BEC 2012 or BEC 2012 (Rev. 1) or BEC 2015 or BEC 2018. In (C), the developer makes a stage 1 declaration to BEC 2021. The works under the developer's/building owner's scope is regarded as completed up to the design only where his/her scope involves no wiring works and hence the BEC requirements on LCP (or also ALC for BEC 2015 or BEC 2018) becomes not applicable. In (A) and (B), the BEC requirements on ALC are not applicable if the concerned building/works are designed to BEC 2012 or BEC 2012 (Rev.1) but not for the case under BEC 2015 or BEC 2018. Moreover, in (C) compliance with ALC is applicable and is under the tenant's scope as discussed later on.

Presumes that the tenant, when moving in, retains all the luminaires in the original location without any change but conducts wiring connection works only. The works is carried out and completed after the full implementation date of the BEC 2021 i.e. on or after 1 October 2022.

Tenant's liability – building unit less than 500m<sup>2</sup> or involved lighting total circuit wattage below 3.0 kW (TG Table 10.1.8 (1) refers)

In (A), compliance with LCP requirements falls within the tenant's scope given the fact that the building has been granted with COCR to BEC 2012 or BEC 2012 (Rev.1) while both LCP & ALC requirement will be necessary to comply if the building has been granted with COCR to BEC 2015 or BEC 2018. However, compliance submission is not required since the works is of non-MRW. Likewise, in (B) the tenant is subject to the similar liability as in (A).

In (C), at the timing when the building is granted with a COCR to BEC 2021, the tenant's liability includes the compliance with the LCP and ALC requirements as enforced under the BEC 2021. Again, compliance submission is not required in this scenario.

Tenant's liability – building unit or works area involved of 500m<sup>2</sup> or above, and involved lighting total circuit wattage at or above 3.0kW (TG Table 10.1.8(1) refers)

In this scenario, when the works involved is **wiring-only**, it is **not regarded as MRW**. The tenant's scope on BEC compliance confines to those issues as elaborated below.

In (A), where the building has been granted with COCR to BEC 2012 or BEC 2012 (Rev.1) or BEC 2015 or BEC 2018, the tenant's scope confines to compliance with LCP requirements for BEC 2012 or BEC 2012(Rev.1), but both LCP and ALC requirement will be necessary for comply for BEC 2015 or BEC 2018. Since his works involves wiring-only works and compliance submission under a FOC is not required for the works **not** regarded as MRW. At the timing of BEC 2021 in force, the tenant still not mandated to comply with ALC requirement if the COCR is under BEC 2012 or BEC 2012 (Rev.1).

In (B), the case of an existing building, including the building units, covered under a FOC to BEC 2012 or BEC 2012 (Rev. 1) or BEC 2015 or BEC 2018, likewise in (A), the tenant confines his scope to compliance with LCP requirement only for BEC 2012 or BEC 2012(Rev.1), but both LCP and ALC requirement will be necessary to comply for BEC 2015 or BEC 2018. When tenants' works is carried out and completed at the timing of BEC 2021 in force, compliance with ALC requirement is not mandatory if the COCR is under BEC 2012 or BEC 2012 (Rev.1).

In (C), a building issued with COCR to BEC 2021, the tenant has to comply with the requirement on LCP and ALC but compliance submission is not required. In the case of new issue of BEC edition (say the BEC 2024), in force, the tenant is

**not** bind to comply with any new or tightened requirements contains under such a latest BEC edition.

- (f) TG Table 10.1.8 (2) – Design compliance to BEC **not** available from Developer/ Building Owner but provides and fixes luminaire only inside building unit:

Presume that the developer/building owner provides and fixes luminaires along the ceiling in each of the building unit (tenant space) without any consideration on LPD compliance to the BEC. In this scenario, those luminaires left ready by the developer/building owner are **not** regarded as the **existing** installation.

When the tenant moves in, whether he has the intention to make full use of the luminaires **without** any change on the lighting layout, those luminaires so connected by his subsequent wiring works are regarded as **addition** under his scope and hence he is liable to take up the LPD compliance and the various compliance requirements to the relevant BEC edition as discussed further below.

Tenant’s liability – building unit less than 500m<sup>2</sup> or involved lighting total circuit wattage below 3.0 kW (TG Table 10.1.8 (2) refers)

In (A), where the building is granted with a COCR to BEC 2012 or BEC 2012 (Rev. 1) or BEC 2015 or BEC 2018, the tenant is liable to comply with the **LPD** and **LCP** requirements under BEC 2012 or BEC 2012(Rev.1), while all the requirements on LPD, LCP and ALC is necessary to comply for BEC 2015 or BEC 2018.

In (B), given an existing building with its building units not covered under any FOC, the tenant is not liable to demonstrate any compliance to LPD, LCP and ALC requirement in this case.

In (C), when the building is granted with a COCR to BEC 2021, the tenant becomes liable to comply with all the requirements on LPD, LCP and ALC to the relevant BEC edition.

Tenant’s liability – building unit or works area involved of 500m<sup>2</sup> or above, and involved lighting total circuit wattage at or above 3.0kW (TG Table 10.1.8 (2) refers)

The works carried out and completed under the tenant’s scope is regarded as MRW in this scenario. It is presumed that, in all the case illustrated below, the works under the tenant’s scope is completed after the full implementation of the BEC 2021 i.e. on or after 1 October 2022.

In (A), where the building is granted with COCR to BEC 2012 or BEC 2012 (Rev. 1) or BEC 2015 or BEC 2018, the tenant is liable to comply with LPD, LCP and ALC requirement as contains under the BEC 2021 and the works should be covered under a FOC to that BEC edition.

In (B), the case of an existing building with no FOC covering any building units, the tenant is under the similar liability as the case in (A) above.

In (C), where the building is granted with a COCR to BEC 2021, the tenant should demonstrate the compliance with LPD, LCP and ALC requirements to BEC 2021 and cover the works under a FOC. As a further illustration by supposing that the latest BEC edition in force is the BEC 2024, the FOC as obtained by the tenant should cover the compliance with the new and tightening requirements under such BEC edition.

**Table 10.1.8 (1) : Developer/Building owner provides and fixes luminaire with design LPD complying with the BEC**

1/10/2022

		Before	After	
		Works conducted by:		
		Developer/Building Owner	Responsible Person (Tenant)	
Design	Lamp & Luminaire Selections	LPD compliance under: (A) a stage 2 declaration (new building w/ COCR to “#1 - BEC 2012 or - BEC 2012 (Rev. 1)” “#2 - BEC 2015)” or “ - BEC 2018”);  (B) a FOC (existing building) to BEC above;  (C) a stage 1 declaration (new building to BEC 2021)	Retains all luminaires fixed in position without any change when moving in	
	Layout			
	LPD Calculation			
Install	Luminaire Fixing	Yes	No	No
	Wiring Connection	No	Yes	Yes
	Lighting Control Point (LCP)	No	Yes	Yes
	Automatic Lighting Control (ALC)	(A)&(B) #1: N/A (A)&(B) #2: No (C): No	(A)&(B) #1: N/A (A)&(B) #2: Yes (C): Yes	(A)&(B) #1: N/A (A)&(B) #2: Yes (C): Yes
Completed	No (installation not yet completed w/o wiring works)	Yes	Yes	
Developer/Building owner completed the design only by demonstrate LPD compliance through stage 2 declaration or a FOC submission			Works area >= 500m <sup>2</sup> and lighting total circuit wattage >3kW?	
			No	Yes

<p>(A) <u>Bldg w/ COCR to BEC 2012 or BEC 2012 Rev1) or BEC 2015 or BEC 2018:</u></p> <ul style="list-style-type: none"> <li>- LCP compliance (and also ALC compliance if bldg w/ COCR to BEC 2015 or BEC 2018) under tenant's scope (maintain the standard not lower than that in the COCR) but submission not required;</li> </ul> <p>(B) <u>Existing Building w/ FOC (to BEC 2012 or BEC 2012 (Rev.1) or BEC 2015 or BEC 2018 by Bldg Owner) for LPD compliance only:</u></p> <ul style="list-style-type: none"> <li>- LCP compliance (and also ALC compliance if ex. bldg w/ FOC to BEC 2015 or BEC 2018) under tenant's scope (maintain the standard not lower than that in the FOC) but submission not required;</li> </ul> <p>(C) <u>The bldg. issued with COCR to BEC 2021 (Developer made stage 1 and 2 declaration to BEC 2021 ) :</u></p> <ul style="list-style-type: none"> <li>- LCP &amp; ALC compliance under tenant's scope (maintain the standard not lower than that in the COCR) but submission not required.</li> </ul>	
<p><u>Works conducted by the Responsible Person not major retrofitting works (MRW) since:</u></p> <ul style="list-style-type: none"> <li>- involved wiring-only works; and</li> <li>- not involving addition or replacement of luminaires (<b>only when all the provided and fixed luminaires comply with the LPD requirement covered by a stage 2 declaration</b> by the developer or <b>a FOC</b> by the building owner)</li> </ul> <p>(A) <u>Bldg w/ COCR to BEC 2012 or BEC 2012 (Rev1) or BEC 2015 or BEC 2018:</u></p> <ul style="list-style-type: none"> <li>- LCP compliance (and also ALC compliance if bldg w/ COCR to BEC 2015 or BEC 2018) under tenant's scope (maintain the standard not lower than that in the COCR) but submission not required;</li> <li>- Compliance with the latest BEC edition (say the BEC 2021 in this case) not required for works not of MRW and ALC requirement not applicable for bldg w/ COCR to BEC 2012 &amp; BEC 2012(Rev.1).</li> </ul> <p>(B) <u>Existing Building w/ FOC (to BEC 2012 or BEC 2012 (Rev.1) or BEC 2015 or BEC 2018 by Bldg Owner) for LPD compliance only:</u></p> <ul style="list-style-type: none"> <li>- LCP compliance (and also ALC compliance if ex. bldg w/ FOC to BEC 2015 or BEC 2018) under tenant's scope (maintain the standard not lower than that in the FOC) but submission not required;</li> <li>- Compliance with the latest BEC edition (say the BEC 2021 in this case) not required for works not of MRW and hence ALC requirement not applicable for ex. bldg w/ FOC to BEC 2012 &amp; BEC 2012(Rev.1).</li> </ul> <p>(C) <u>The bldg. to be issued with COCR to BEC 2021 (Developer made stage 1 and 2 declaration to BEC 2021)</u></p> <ul style="list-style-type: none"> <li>- LCP and ALC compliance under tenant's scope (maintain the standard not lower than that in the COCR) but submission not required;</li> <li>- Compliance with the latest BEC edition (even when the case with BEC <u>2024</u> is fully enforced) not required for works not of MRW.</li> </ul>	

**Table 10.1.8 (2): Developer/Building owner provides and fixes luminaire only without design LPD design complying with the BEC**

1/10/2022

		Before	After	
		Works conducted by:		
		Developer/Building Owner	Responsible Person (Building Owner/Unit Owner/Tenant)	
Design	Lamp & Luminaire Selection	Specified lamp & luminaire	No (simply pick up those left ready by the developer / building owner)	
	Layout	No	Yes (based on actual usage, space layout and partitioning)	
	LPD Calculation	No	Yes or N/A	
Install	Luminaire Fixing	Only provide & fix the luminaires in position and lined up with false ceiling grids	Adjust luminaires to suit the usage, space layout and partitioning etc. (regarded as addition & replacement)	
	Wiring Connection	No	Yes	Yes
	Lighting Control Point (LCP)	No	Yes	Yes
	Automatic Lighting Control (ALC)	N/A or No	N/A or Yes (see below)	Yes
Completed		No	Yes	Yes
No design conducted since no demonstration of any compliance under any submission and those luminaires so provided and fixed not regarded as the existing.		Works area $\geq 500\text{m}^2$ and lighting total circuit wattage $> 3\text{kW}$ ?		
		No	Yes	

<p>All luminaires are regarded as addition:</p> <p>(A) <u>Building w/ COCR to BEC 2012 or BEC 2012 (Rev. 1) or BEC 2015 or BEC 2018</u></p> <ul style="list-style-type: none"><li>- LPD &amp; LCP compliance (and also ALC compliance if bldg w/ COCR to BEC 2015 or BEC 2018) under tenant's scope (maintain the standard not lower than that in the COCR) but submission not required;</li></ul> <p>(B) <u>Existing Building</u></p> <ul style="list-style-type: none"><li>- LPD, LCP &amp; ALC compliance not applicable in this case;</li></ul> <p>(C) <u>Building to be issued with COCR to BEC 2021 (Developer made stage 1 &amp; stage 2 declaration to BEC 2021)</u></p> <ul style="list-style-type: none"><li>- LPD, LCP &amp; ALC compliance under tenant's scope (maintain the standard not lower than that in the COCR) but submission not required.</li></ul>	
<p>Works conducted and completed by the Responsible Person is MRW since involving addition of luminaires and wiring works:</p> <p>(A) <u>Building w/ COCR to BEC 2012 or BEC 2012 (Rev. 1) or BEC 2015 or BEC 2018</u></p> <ul style="list-style-type: none"><li>- LPD, LCP &amp; <b>ALC</b> compliance under tenant's scope and covered under a FOC submission.</li></ul> <p>(B) <u>Existing Building</u></p> <ul style="list-style-type: none"><li>- LPD, LCP &amp; <b>ALC</b> compliance under tenant's scope and cover under a FOC submission.</li></ul> <p>(C) <u>Building to be issued with COCR to BEC 2021 (Developer made stage 1 and 2 declaration to BEC 2021)</u></p> <ul style="list-style-type: none"><li>- LPD, LCP &amp; ALC compliance under tenant's scope (maintain the standard not lower than that in the COCR) and cover under a FOC submission to BEC 2021.</li><li>- Compliance submission to the latest BEC edition (for the case the BEC 2024 is fully enforced ) and cover under a FOC submission to BEC 2024.</li></ul>	



#### 10.1.9 Relocation of Luminaires

When complying with the following listed conditions, it is regarded as the works involving relocation of luminaires:

- (1) Where the luminaires involved are connected to power supply and in use before;
- (2) Repositioning of the luminaires involved taking place within the same lighting space;
- (3) The repositioned luminaires involved are of the same type; and
- (4) There is no change of lighting power density of the lighting space before and after the works.

Works regarded as “relocation of luminaires” is not regarded as “additional or replacement of luminaires” under the BEC.

#### 10.2 Performance-based Approach (BEC clause 10.2)

Performance-based approach is applicable to major retrofitting works. Certain guidance in respect of retrofitting is given in BEC Appendix A clauses A1.4, A3.1.1, A3.2.5(a), A3.2.6(a), A3.2.9 and A3.2.10. With clauses A3.2.5(a) and A3.2.6(a) specifying the adoption of the as-built system in the modelling, the trade-off if any in design energy would confine to items within the same series of major retrofitting works.

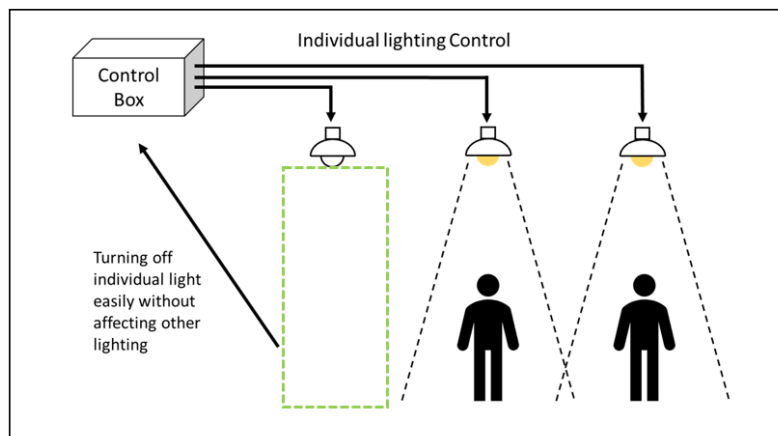
## 11. Emerging Good Engineering Practice

### 11.1 Lighting Installation

#### 11.1.1 Addressable Lighting Control

Lighting accounts for approximately 10% of the total electricity end-use in Hong Kong. On top of fulfilling the LPD requirement and automatic lighting control, a popular strategy to reduce the lighting electricity consumption is to adopt energy-efficient lighting control. Addressable lighting control provides variations on light scene and luminaire output in response to the requirements of the activity and the indoor availability of daylighting. It can be implemented in separated zones by grouping the luminaires into different addresses. Individual command can be assigned to each group of luminaires, providing high system control flexibility. A common practice of addressable lighting control can be seen at the perimeter zones of a building, where daylight penetrates through fenestrations and openings. Lighting space with multiple zone and different operation mode (i.e. indoor games hall / exhibition hall) would also adopt addressable lighting control to enhance the flexibility on the utilization of the venue and to suit various functional needs. With the appropriate programming, lower electricity consumption and higher energy efficiency can be achieved.

**Figure 11.1.1 : Illustration of addressable lighting control**

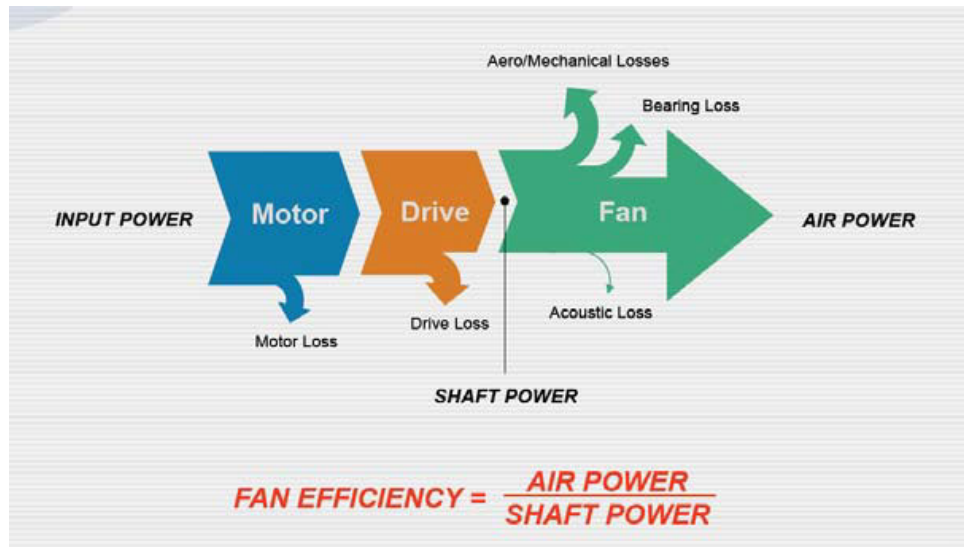


### 11.2 Air-conditioning Installation

#### 11.2.1 Fan Efficiency Grade (FEG)

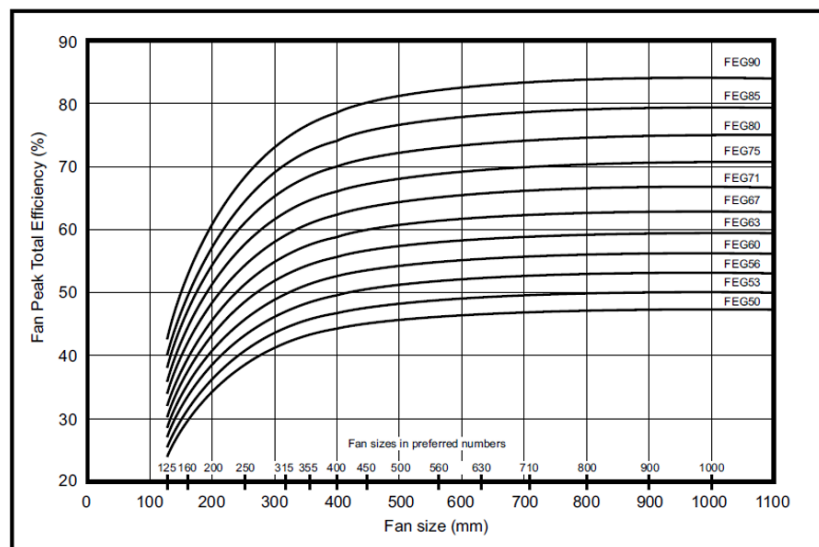
To maximize the energy saving, Fan Efficiency Grade (FEG) from ANSI/AMCA 205-12 could be referred during fan selection. FEG is an indicator introduced by Air Movement and Control Association International (AMCA) to classify fan by their aerodynamic ability to convert mechanical shaft power, or impeller power in the case of a direct driven fan, to air power which applies to the efficiency of the fan only and not to the motor and drive.

**Figure 11.2.1 (a) : Fan Efficiency**

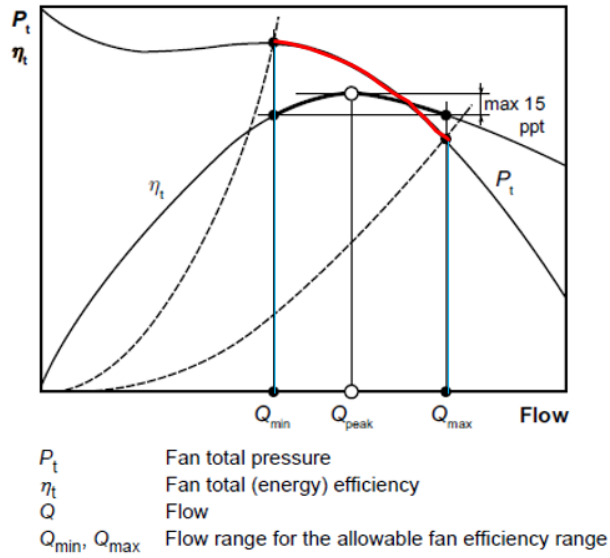


The fans selected is recommended to have a fan efficiency grade (FEG) of 67 or higher based on manufacturers’ certified data. In order to achieve energy savings by selecting and operating fan close to the peak of the fan efficiency. AMCA also suggests the fan operating efficiency at all intended operating point(s) need to be not less than 15 percentage points below the fan peak total efficiency. Similar requirements can also be found in ASHRAE 90.1-2016 clause 6.5.3.1.3. The fan efficiency from ANSI/AMCA 205-12 is extracted below for reference. (For further details, <https://www.amca.org/certify/certified-product-search/license-type/feg.html>)

**Figure 11.2.1 (b) : Fan Efficiency Grade (FEG)**



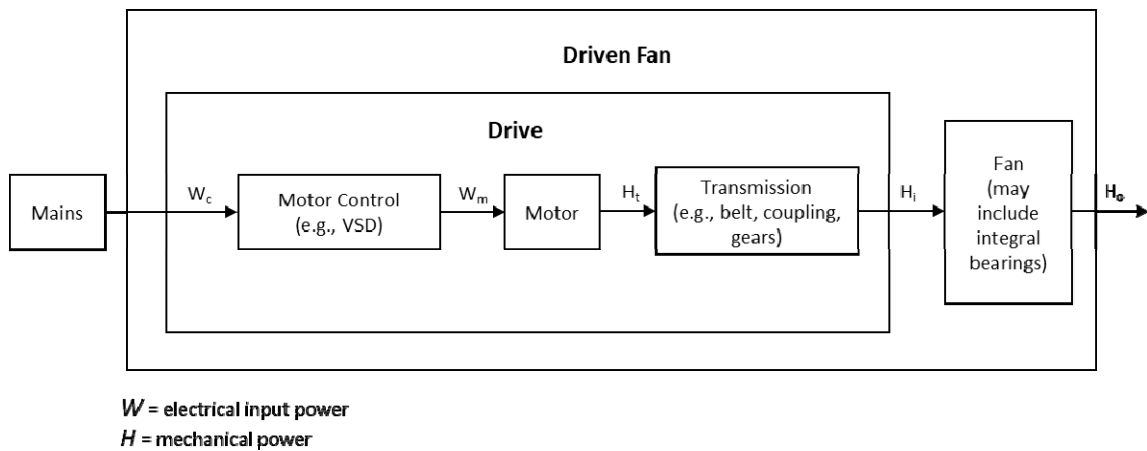
**Figure 11.2.1 (c) : Allowable Selection Range within 15 percent point of Fan Peak Total Efficiency**



11.2.2 Fan Energy Index (FEI)

Different from the Fan Efficiency Grade (FEG) mentioned above, there is updated with the use of Fan Energy Index (FEI) from AMCA 208 during fan selection. It is an indicator introduced by Air Movement and Control Association International (AMCA) to describe the overall efficiency, wire-to-air metric that include fan efficiency with motors and drive components used to operate a fan.

**Figure 11.2.2 : Fan Energy Index (FEI)**



### 11.2.3 High Efficiency Fan

An electronically commutated (EC) fan can improve the energy efficiency of an air-conditioning system. In a conventional air-conditioning system, alternating current (AC) motor is used to drive the fan. But for EC fan, high-performance direct current (DC) motor is used instead. In addition, an EC fan employs DC speed control technology that can vary the speed in accordance with the control target (such as temperature) without the use of a frequency converter. This allows more precise control, but less energy is consumed.

Example to compare the energy saving by replacement of belt driven fan with the EC motor plug fans at the air handling unit in a typical floor of office building:

<b>Table 11.2.3 : Comparison between old belt driven fan and EC motor plug fans</b>		
<u>Design parameter in the example</u>		
(a) <u>Area of the typical office floor: ~1,500 m<sup>2</sup></u>		
(b) <u>Design air flow rate: ~11,000 l/s</u>		
(c) <u>Design static pressure: ~1150 Pa</u>		
<u>Fan Type</u>	<u>Rated Power</u>	<u>Total Electricity Consumption (in a year)</u>
Old belt driven fan	22 kW	~ 30,000 kWh
EC motor plug fans (4 nos.)	20.2 kW (4 x 5.05 kW)	~ 18,000 kWh

As shown in the table above, the case study demonstrated significant energy reduction by replacing an old belt driven fan with 4 no. of EC motor fan. In addition, the modular and compact design for the EC motor plug fans take advantage on the retrofitting works in terms of the space for delivery and installation works in the existing buildings.

### 11.2.4 Water Pump Efficiency

The EU MEPS (European Minimum Energy Performance Standard) scheme has set up mandatory minimum hydraulic efficiency levels for the water pumps in Europe. The European Commission has benchmarked all pumps in the market under such standard and established a formula to calculate the minimum hydraulic efficiency value. The purpose of the standard is to eliminate the pumps with low hydraulic efficiency. Only water pumps comply with the directive can be sold. (The “water pump” in this standard refers to the hydraulic part of a device that moves clean water with the design of end suction, vertical multistage and submersible multistage type.)

The requirement is presented in the form of Minimum Efficiency Index (MEI). The MEI concern the pump efficiency and it considers the pump operation at the best efficiency point (BEP), over load (OL) and part load (PL). The MEI compares the efficiency with the market available product. For example, a pump with MEI of 0.4 means 40% of the market available pumps are less efficient than that pump. Thus, the higher the MEI, the greater the efficiency.

Instead of only considering the operating point efficiency, the MEI introduce a good practice for the industry to consider the pump efficiency.

#### 11.2.5 Installing Wet-bulb Air Temperature Sensors at Cooling Towers

Another good engineering practice for energy saving is the installing of sensors at cooling towers for additional building performance indicator's monitoring and future retro-commissioning opportunities. By installing the outdoor dry bulb air temperature and outdoor RH or simply a wet-bulb air temperature sensor around the cooling towers, the system could obtain the instant outdoor wet-bulb temperature. This data could be further compare with approach temperature and condensing water entering temperature for optimizing the operation of cooling tower such as reducing the number of cooling tower operations or the speed of the cooling tower fans. More information on the energy saving strategies and calculation could be found in the Technical Guidelines on Retro-commissioning.

[https://www.rcxrc.emsd.gov.hk/en/technical\\_guideline.php](https://www.rcxrc.emsd.gov.hk/en/technical_guideline.php)

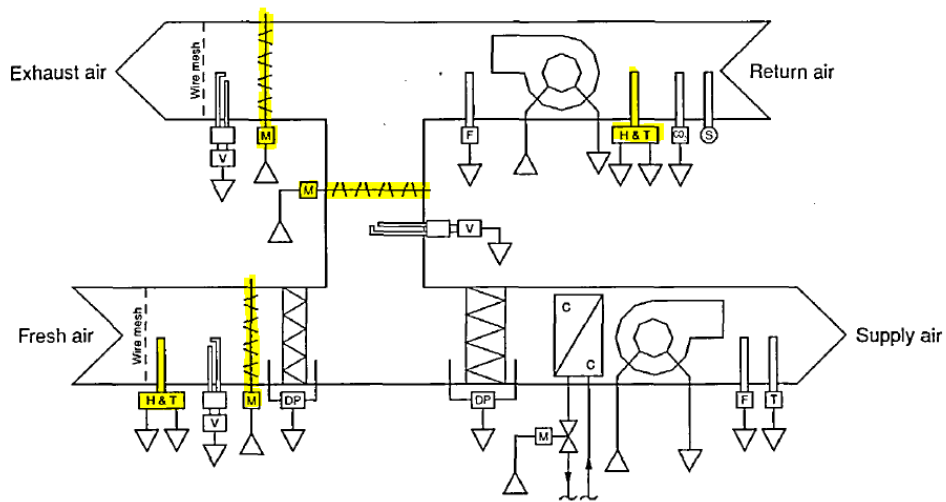
#### 11.2.6 Free Cooling

Free cooling is an economical method of using outdoor air to assist in the cooling system to reduce the cooling demand in the air-conditioning system. When certain condition is reached, such as outdoor air temperature and humidity are appropriate and outdoor air enthalpy is lower than the indoor air enthalpy, free cooling mode could be activated. The cooler outdoor air will be utilized as a cooling source to overcome the interior load / part of interior load. This reduces the cooling demand from the traditional air conditioning systems as it eliminates the chiller operation (compressor to run less) during mild or cold weather season.

During design process, increase in the size of fresh air duct should be considered for incorporating free cooling design. It is better for designer/REA to calculate and determine the required duct size such that the outdoor air could cater for certain interior loading of that serving area. Hence, for spaces such as indoor game hall or theatre, they are the potential locations to consider free cooling design as an energy saving strategy since the demand of fresh air is high with large number of occupants in the space.

To implement the free cooling control, outdoor temperature sensor and RH sensor should be deployed to measure the outdoor conditions and calculate the enthalpy of outdoor air. When suitable condition (i.e. the enthalpy value of outdoor air is lower than that of indoor air) is reached and come to a steady level, free cooling mode could be activated. Modulated dampers are required in fresh air duct, mixed air duct and exhaust air duct (if any) to increase the supply of outdoor air to treat the interior load.

**Figure 11.2.6 Enthalpy sensors and modulated dampers to control and adjust the supply of outdoor air for free cooling mode**

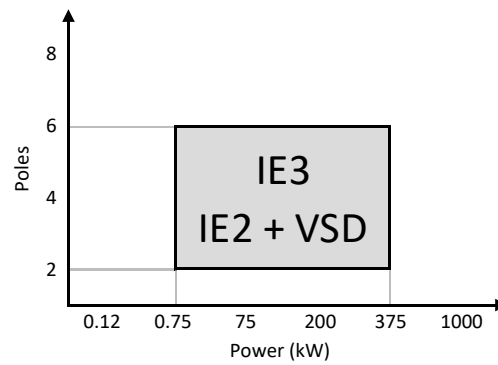


### 11.3 Electrical Installation

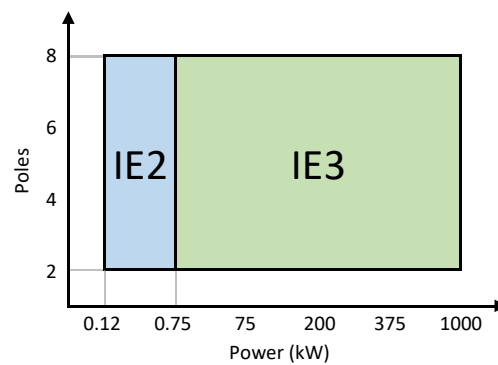
#### 11.3.1 High Efficiency Motor

In 2011, the EU implemented minimum efficiency performance standards (MEPS) for electric motors used in residential, commercial, and industrial applications with Commission Regulation (EU) 640/2009, it mandates the use of at least IE3 or IE2 with VSD for 0.75kW – 375kW. However, starting from 1st July 2021, it was replaced by the New Ecodesign Regulation (EU) 2019/1781. The new regulation illustrates two stages implementation. The first stage includes extending the coverage of motor efficiency requirement from 0.12kW to 0.75kW to be IE2 motor, and only IE3 motor is accepted for 0.75kW - 1000kW. In the second stage, starting from 1st July 2023, motors with power 75kW to 200kW will be mandatory for IE4 (for speeds including 2, 4 and 6 pole) in Europe. It is foreseeable that more IE4 motors will be available in the market in future and designer may consider to apply these high efficiency motors in the building design.

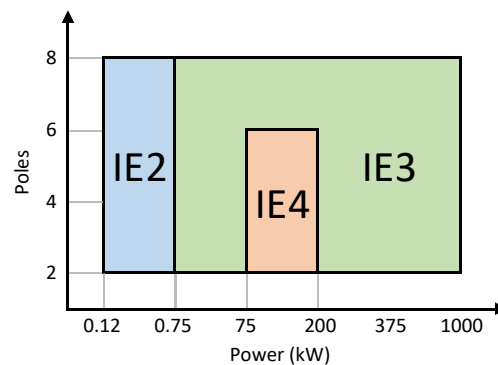
**Figure 11.3.1 (a) Previous Regulation (EU) 640/2009**



**Figure 11.3.1 (b) New Ecodesign Regulation (EU) 2019/1781 (from 1st July 2021) Stage 1**



**Figure 11.3.1 (c) New Ecodesign Regulation (EU) 2019/1781 (from 1st July 2023) Stage 2**





### 11.3.2 Separate Metering for Plug Load (Receptable Load / Small Power Load)

Plug loads / receptable loads / small power loads mean the equipment powered by plugging into a socket. It usually includes computer, photocopiers, printer, micro-oven etc in buildings. It was estimated that plug loads of office equipment accounted for more than 20% of electricity consumption in commercial office. Traditional design usually shares the same incoming circuitry to the MCB for lighting and small power, with a meter to measure the electricity consumption of both systems. Hence, it is recommended to explore the consideration on separate metering / IoT smart metering to monitor the energy consumption of small power (plug load/receptable load) and record the electricity consumption respectively.

Automatic receptable control has been included in ASHRAE standard and mentions to achieve at least 50% of all 125V, 15A or 20A receptacles be automatically controlled in a list of spaces including private offices, classrooms, conference rooms, and others, and in some cases based on area requirement. Reference can be made on the energy saving measures on the plug load.

## 11.4 Lift and Escalator Installation

### 11.4.1 Normalization & Monitoring of Lift Energy Consumption

A relatively new idea has emerged in recent years in respect of normalizing the lift energy consumption based on its energy consumed per unit load per unit distance travelled. As introduced in section 13.5.2 of CIBSE Guide D, the idea was put forth in an article (by Lam, So and Ng) for an international elevator congress<sup>@</sup>. A benchmarking parameter, *J/kg-m*, has been suggested, which can reflect the energy performance of a lift or a bank of lifts accounting for both the power consumption of the motor drive as well as the intelligence of the supervisory controls.

Information on three parameters are needed to evaluate *J/kg-m*, namely energy consumption in Joule (3.6 MJ is equivalent to 1 kWh), car load *W* in kilogram (kg) and distance *D* travelled in metres (m). Within a time period *T*, the total energy *E<sub>T</sub>* consumed by one lift or a bank of lifts can be measured. Within *T*, there are *n* number of brake-to-brake journeys, which starts at the moment when the brake is released at the departing floor until it is applied again at the destination floor. For each journey, the *i*<sup>th</sup> journey, car load *W<sub>i</sub>* and distance travelled *D<sub>i</sub>* irrespective of direction, can be measured. The following equation relates the three parameters –

$$J/kg-m = \frac{E_T}{\sum_{i=1}^n W_i D_i}$$

*T* can be as short as half an hour, an hour, a day or even a week. But once *T* is determined, it should remain unchanged as far as possible for subsequent comparisons. Lift operators/owners may continuously monitor the normalized energy consumption based on these parameters and once a data pool big enough is available, it is possible to establish a benchmark for comparison among different lifts. Again, the same *T* should preferably be used when comparing the energy performance of different lifts or lift banks.

The lower the *J/kg-m* figure, the lower would be the energy consumption of the lift; certain previous measurements indicate figures ranging from 30 to around 150.

@ Lam D.C.M., So A.T.P., Ng T.K., "Energy conservation solutions for lifts and escalators of Hong Kong Housing Authority", Elevator Technology 16, Proceedings of 16th World Congress on Elevator Technologies, The International Association of Elevator Engineers, Helsinki, June, 2006, pp. 190-199

Another benchmarking parameter is introduced in section 6.2 of ISO 25745-2 – specific running energy for the average running cycle  $E_{spc}$  (mWh/kg-m). It reflects the energy performance of a lift or a bank of lifts accounting for both the power consumption of the motor drive as well as the intelligence of the supervisory controls.

Information on four parameters are needed to evaluate  $E_{spc}$  (mWh/kg-m), namely the load factor  $k_L$  – describing the ratio between the running energy used by a lift car carrying an average load and that with an empty car, the running energy consumption of an average cycle  $E_{rav}$  in watt-hour (Wh), the rated load of the car  $Q$  in kilogram (kg) and the one-way average travel distance for target installation in metres (m). The formula of the  $E_{spc}$  is as the following.

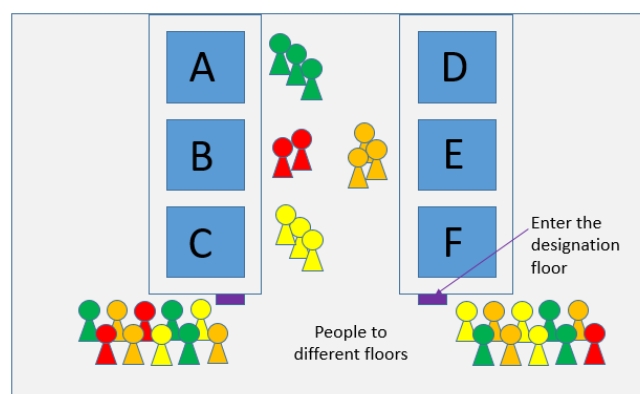
$$E_{spc} = \frac{1\,000 \times k_L \times E_{rav}}{2 \times Q \times s_{av}}$$

The lower the  $E_{spc}$  figure, the lower would be the energy consumption of the lift.

#### 11.4.2 Lift Traffic Management

Lift traffic management (such as lift destination group control) is a control system to operate the lift system efficiently. It arranges or manages the lift traffic to pick up different groups of passengers by knowing their destination. This system is usually used for reducing waiting time and improving lift performance. It is commonly used in commercial office buildings where occupants have regular pattern to go to the office floor. REA/designer should fully consider the suitability of employing this control system for lift installation according to the usage of buildings and passenger patterns, as well as other architectural design factors including the lift lobbies arrangement, zoning and configuration of the lifts, etc. In fact, the lift traffic management relies on different control algorithms for optimization. Hence, proper consideration on the algorithm / parameters in grouping passengers for lift system with lift destination group control can inevitably reduce energy use.

**Figure 11.4.2 Illustration of the destination group control system**





**Electrical and Mechanical Services Department**  
3 Kai Shing Street, Kowloon Bay, Hong Kong  
Tel: (852) 3757 6156 Fax: (852) 2890 6081  
Homepage: <https://www.emsd.gov.hk/beeo/>  
e-mail: [mbec@emsd.gov.hk](mailto:mbec@emsd.gov.hk)