

# **Code of Practice for Water-cooled Air Conditioning Systems**

Part 1: Design, Installation and Commissioning  
of Cooling Towers

2006 Edition



CODE OF PRACTICE  
FOR  
WATER-COOLED AIR CONDITIONING SYSTEM  
  
PART 1: DESIGN, INSTALLATION AND COMMISSIONING  
OF COOLING TOWERS  
  
2006 EDITION

Electrical and Mechanical Services Department  
The Government of the Hong Kong Special Administrative Region

## Foreword

This Code of Practice was prepared to promote the proper use of water-cooled air conditioning systems with guidelines for cooling tower design, installation, testing, commissioning, operation and maintenance in order to meet the energy efficiency objective with due consideration of the environment and health issues. It was developed by the Task Force on Code of Practice for Water-cooled Air Conditioning Systems and Ove Arup & Partners Hong Kong Ltd.

The Part 1 of this series of Code of Practice for Water-cooled Air Conditioning Systems provides details on the design, installation and commissioning of cooling towers. It shall be read in conjunction and made cross-reference with the followings:

Part 2 – Operation and Maintenance of Cooling Towers

Part 3 – Water Treatment Methods for Cooling Towers

## Contents

	Page
Forward	ii
List of Abbreviations	v
Definitions	vii
1. Introduction	1
1.1 Scope	
1.2 Objectives	
1.3 Applications	
2. Cooling Tower Types and Cooling Tower Systems	3
2.1 General	
2.2 Cooling Tower Types	
2.3 Cooling Tower System	
3. Cooling Tower Construction and Installation Requirements	10
3.1 Cooling Tower Shell	
3.2 Intake Louvre	
3.3 Fill	
3.4 Fan and Fan Motor	
3.5 Water Basin	
3.6 Drift Eliminator	
3.7 Water Distribution Pipework	
3.8 Water Circulation Pipework	
3.9 Water Sampling Point	
3.10 Deflector	
3.11 Silencer	
3.12 Plume Abatement Device	
3.13 Access Opening	
3.14 Cooling Tower Structure	
3.15 Ladder and Handrail	
3.16 Installation Access	
3.17 Cooling Tower Supporting Framework	
4. Cooling Tower Installed Location	17
4.1 General	
4.2 Cooling Towers installed on Building Roof	
4.3 Cooling Towers installed on Podium Roof	
4.4 Cooling Towers installed in Indoor with Vertical Discharge through Roof or Horizontal Discharge through Side Wall	
4.5 Cooling Towers installed at Other Locations	
4.6 Minimum Separation between Cooling Towers	
4.7 Minimum Separation from Physical Barrier	
4.8 Installed Location not fulfilling the Required Minimum Separation	
5. Cooling Tower Water and Bleed-off Water Control	21
5.1 Cooling Water Quality Control	
5.2 Bleed-off Control and Re-use of Bleed-off Water	
6. Notices and Labels	24

7.	Risk Management of a Cooling Tower System	25
7.1	Installed Locations that required submission of Risk Management Plan	
7.2	Risk Management Plan	
8.	Testing and Commissioning of Cooling Tower Systems	27
8.1	Testing and Commissioning	
8.2	Occupational Safety and Health	
9.	Design and Commissioning Records	28
10.	Qualification of System Designer	29
11.	Reference Information	30

#### Appendices

Appendix 1A –	Minimum Separation Requirement for Cooling Towers
Appendix 1B –	Typical Risk Management Plan for Water-cooled Air Conditioning System
Appendix 1C –	Sample Checklist for Minimum Testing and Commissioning Procedures of Water-cooled Air Conditioning Systems
Appendix 1D –	Recommended List of Personal Protective Equipment

#### List of Figures

Figure 1.1 –	Classification of cooling tower
Figure 1.2 –	Types of cooling towers
Figure 1.3 –	Typical configuration of induced draft counter flow cooling tower
Figure 1.4 –	Typical configuration of induced draft cross flow cooling tower
Figure 1.5 –	Typical configuration of forced draft counter flow cooling tower
Figure 1.6 –	Typical configuration of forced draft cross flow cooling tower
Figure 1.7 –	Typical configuration of closed-circuit cooling tower
Figure 1.8 –	Typical configuration of evaporative condenser
Figure 1.9 –	Schematic diagram for typical water-cooled air conditioning system
Figure A1 –	Minimum separation requirement for cooling towers installed on building roof
Figure A2 –	Minimum separation distance requirements for cooling tower installed on podium roof
Figure A3 –	Cooling towers installed in indoor with discharge through roof
Figure A4 –	A plan view for Figure A3
Figure A5 –	Cooling towers installed in indoor with discharge through side wall
Figure A6 –	A plan view for Figure A5

#### List of Tables

Table 1.1 –	Minimum horizontal separation distance from cooling towers
Table 1.2 –	Indicative cooling water quality table for fresh water type cooling tower
Table 1.3 –	Indicative cooling water quality table for sea water type cooling tower
Table 1.4 –	Water quality requirements for flushing water

## List of Abbreviation

AS	Australian Standard
AP	Authorized Person
AMP	Aminotris [methylene phosphonic acid]
APCO	Air Pollution Control Ordinance
APHA	American Public Health Association
ARI	Air Conditioning and Refrigeration Institute
BCYE	Buffered charcoal yeast extract
BCDMH	bromo-3-chloro-5, 5-dimethylhydantoin
BO	Buildings Ordinance
BOD <sub>5</sub>	5 days Biochemical oxygen demand
BS	British Standard
BTA	Benzotriazole
CFD	Computational Fluid Dynamic
CFU	Colony forming Unit
COD	Chemical Oxygen Demand
CoP	Code of Practice
CTSC	Cooling Tower Specialist Contractor
DBNPA	2,2-dibromo-3-nitrilopropionamide
DFA	Direct fluorescence antibody
DNA	Deoxyribonucleic acid
DSD	Drainage Services Department, HKSAR Government
EMSD	Electrical and Mechanical Services Department, HKSAR Government
EPD	Environmental Protection Department, HKSAR Government
FRP	Fibreglass Reinforced Polyester
HCC	Heterotrophic colony count
HEDP	(1-hydroxyethylidene) diphosphonic acid
HKPLDC	Prevention of Legionnaire's Disease Committee, Hong Kong
HKSAR	Hong Kong Special Administrative Region of the People's Republic of China
HOKLAS	Hong Kong Laboratory Accreditation Scheme
ISO	International Organization for Standardization
MBT	Methylene-(bis)thiocyanate
MoO <sub>4</sub>	Molybdate

MSDS	Material safety data sheet
NCO	Noise Control Ordinance
NZS	New Zealand Standard
O&M	Operation and Maintenance
ORP	Oxidation Reduction Potential
OSHO	Occupational Safety and Health Ordinance
PBTC	2-Phosphonobutane-1,2,4-tricarboxylic acid
PCR	Polymerase chain reaction
PO <sub>4</sub>	Phosphosphate
ppm	Parts per million
PVC	Polyvinyl Chloride
Quats	Quaternary ammonium salts
RPE	Registered Professional Engineer
SSO	Sewage Services Ordinance
T&C	Testing and Commissioning
TBC	Total Bacteria Count
TCCA	Trichloroisocyanuric acid
TDS	Total Dissolved Solid
TTA	Tolytriazole
TTPC	Tributyl tetradecyl phosphonium chloride
WACS	Water-cooled Air Conditioning Systems
WPCO	Water Pollution Control Ordinance
WSD	Water Supplies Department, HKSAR Government
WWO	Waterworks Ordinance
Zn	Zinc

**Definitions:**

- Aerosol : A suspension in a gaseous medium of solid particles, liquid particles or solid and liquid particles having negligible falling velocity.
- Algae : Multicellular plants found in water or moist ground, that contain chlorophyll but lack true stems, roots and leaves.
- Area of public access : Sitting-out area, playground or places where people would gather together for activities.
- Bacteria : A microscopic, unicellular (or more rarely multicellular) organism (singular: bacterium).
- Biocide : A physical or chemical agent that kills bacteria and other microorganisms.
- Biodispersant : A chemical compound added to the water inside cooling tower system, to penetrate and break down any biofilm that may be present on the wetted surfaces of the cooling tower system.
- Biofilm : A surface layer of microorganisms. It is usually combined with particulate matter, scale and products of corrosion.
- Bleed off (blowdown) : The removal of water from a cooling tower system to maintain the concentration of total dissolved solids and suspended solids in an acceptable level.
- Commissioning : A systematic and progressive process of putting the components of a system into operation, calibrating instruments and controls, and then making adjustments and checks to ensure that the total system is providing satisfactory operation and performance.
- Cooling tower : A device for lowering the temperature of water by evaporative cooling in which ambient air is in contact with falling water, thereby exchanging heat. The term also includes those devices that incorporate a water-refrigerant or water-water heat exchanger (evaporative condenser or closed-circuit cooling tower).
- Cooling tower system : A heat exchange system comprising a heat-generating plant (chiller condenser or heat exchanger), a heat-rejection plant (cooling tower or evaporative condenser) and interconnecting water recirculating pipework and associated pumps, valves and controls. Cooling tower systems is considered as a part of WACS.



Corrosion coupon	:	Small strip of metal, usually placed into water circuits so that they can easily be removed, to enable the corrosion characteristics of the water to be assessed.
Corrosion inhibitor	:	Chemical which protects metals by: (a) passivating the metal by the promotion of a thin metal oxide film (anodic inhibitors); or (b) physically forming a thin barrier film by controlled deposition (cathodic inhibitors).
Corrosion resistant	:	Material that is not inherently susceptible to rapid corrosion under the conditions normally prevailing in the system.
Cycle of concentration	:	The ratio between the concentration of dissolved solids in the cooling water and the concentration of dissolved solids in the make-up water as a result of the evaporation that takes place in the cooling tower
Dead leg	:	Water pipe with length equal to or larger than one diameter of the pipe, ending at a fitting through which water flows only when the fitting is opened. These extra areas of the cooling tower system contain stagnant water, which can cause building up of bacteria and sludge in recirculating system, and can then contaminate the system.
Decontamination	:	A process used when a cooling tower system is found with a level of bacterial count which involves a series of actions to disinfect, clean and re-disinfect the cooling tower system.
Disinfection	:	Preventive maintenance action of applying a treatment to a system, in conjunction with system cleaning, in order to reduce the general concentration of infectious agents.
Dispersant	:	Reagent usually added with other treatment chemicals to prevent accumulation of sludge.
Drift eliminator	:	A grid or grill-like arrangement of physical barriers located before the cooling tower exhaust designed to minimize the drift emanating from a tower.
Drift	:	Water lost from the cooling tower as liquid droplets or aerosols entrained in the exhaust air, excluding condensation.
Evaporative condenser	:	A heat exchanger in which refrigerant is cooled by a combination of air movement and water spraying.
Exhaust air outlet	:	A termination of a mechanical or natural ventilation system that allows air removed from a space and discharged outside the building. The exhaust air outlets, which are crucial in the consideration of separation distance with the cooling tower, are exhausts from kitchens, toilets, emergency generator (flue

		gas), carpark ventilation, fume cupboard and refuse collection room, and any exhaust that contains contaminants or nutrients for microbial growth in cooling water.
Fan	:	A rotary machine which propels air continuously. This is used for moving air in a mechanical draft tower. The fan may be of induced draft or forced draft application.
Fill (packing)	:	Material placed within cooling tower to increase heat and mass transfer between the circulating water and the air flowing through the tower.
Filtration	:	The process of separating solids from a liquid by means of a porous substance through which only the liquid passes.
Fouling	:	Organic growth or other deposits on heat transfer surfaces causing loss in efficiency.
Heterotrophic colony count (HCC)	:	The number of viable units of bacteria per millilitre of water sample. It is also known as Total Bacteria Count (TBC), Total Plate Count or Viable Bacteria Count.
Legionnaires' disease	:	An illness characterized by pneumonia and caused by infection with legionella bacteria species, commonly Legionella pneumophila.
Legionella count	:	The number of Legionella colony-forming units (CFU's) found in one millilitre of the water sample.
Maintenance	:	Regular routine activity aimed at preserving the operational standard and cleanliness of equipment, which includes inspection, repair, preventive service and cleaning.
Maintenance programme	:	Assembly of relevant data and the setting out of a formal strategy and recording system for the effective management of a series of maintenance procedures.
Maintenance report	:	Written communication, giving details of the physical and operational state of a piece of equipment when maintenance is carried out, which is sent to the building owner or agent.
May	:	Indicates that a course of action is permissible and the existence of an option.
Medical and health facilities	:	Hospitals, general clinics, specialist clinics; community support facilities for the elderly, such as residential elderly homes, social centre for the elderly; and establishments providing health care and services for the sick and infirm.

Non-oxidising biocide	:	A non-oxidising biocide is one that functions by mechanisms other than oxidation, including interference with cell metabolism and structure.
Operable window	:	An operable window is a window that has moving parts, such as hinges, and can be opened. If a window is permanently locked or required special tools to be opened, that window would not be considered as an operable window when examining the separation distance.
Outdoor air intake	:	A termination of a mechanical or natural ventilation system that allows ambient air entering a building. The outdoor air intakes, which are crucial in the consideration of separation distance with the cooling tower, are fresh air intake for the air conditioning system of a building, and any air intake that draws outdoor air into the building.
Oxidising biocide	:	Agents capable of oxidizing organic matter, e.g. cell material enzymes or proteins which are associated with microbiological populations resulting in death of the micro-organisms.
Passivation	:	The formation of a protective film, visible or invisible, which controls corrosion.
Pedestrian thoroughfares	:	A heavily travelled passage for the public from one place to another.
Plume	:	The visible discharge of air and moisture from a cooling tower due to condensation. It is usually most visible in cool and humid days when water vapour emanates from the cooling tower exhaust.
Podium Roof	:	Roof of the lower part of a building.
Scale	:	A crystalline deposit that can form on surfaces or pipework within the cooling tower system due to build up of minerals (usually calcium carbonate)
Scale inhibitor	:	Chemicals used to control scale. They function by holding up the precipitation process and / or distorting the crystal shape, thus preventing the build-up of a hard adherent scale.
Shall	:	Indicates that the statement is mandatory.
Sludge	:	A build up of sediment that can be found in the basin or pipework of a cooling tower system.

- Slug dosing / Shock dosing : The process of adding in a single dose a much higher amount of chemical biocide than is normally applied, with the intention of rapidly raising the concentration of biocide in the water to a level expected to kill most of the organisms in the water.
- Spray nozzle : A device used in an open distribution system to break up the flow of the circulating water into droplets, and effect uniform spreading of the water over the wetted area of the tower.
- Stagnant water : Pockets of motionless water within the cooling tower system that can allow microorganisms to grow.
- Temporary shut-down : Cooling tower temporarily shut-down is the entire / part of the system not in function and isolated from the main water-cooled condenser / heat exchanger to avoid contamination. Standby unit(s) with cooling water running once a week is not defined as temporary shut-down.

## **1. Introduction**

### **1.1 Scope**

This Part of the Code of Practice specifies the minimum requirements and good practices for the design, installation and commissioning of cooling tower systems. This outlines the prescriptive requirements to minimize the risk of using cooling towers, and to maximize the system operating performance and reasonable energy efficiency in both design and construction stages. Emphasis has been put on the followings:

- a) System design and construction;
- b) Minimization of water loss;
- c) Installed location of towers; and
- d) System commissioning.

### **1.2 Objectives**

This Part of the Code of Practice aims to provide guidelines and technical reference to every party involved in the design, installation and commissioning of cooling tower system so as to achieve the following objectives:

- a) Assure public health and safety by preventing any potential risk associated with water-cooled air conditioning system;
- b) Achieve better / maintain energy efficiency and operational performance of water-cooled air conditioning system;
- c) Minimize nuisances caused by water-cooled air conditioning system to the public;
- d) Prevent pollution and mis-use of water;
- e) Assure occupational safety and health of the staff concerned.

### **1.3 Applications**

**1.3.1** This Code of Practice is intended for use by building owners, cooling tower system owners, cooling tower system designers, building professionals, building and services contractors, cooling tower specialist contractors, operation and maintenance staff, and manufacturers and suppliers, etc, responsible for design, installation and commissioning of water-cooled air conditioning systems. It shall be

applied to the newly installed systems, as well as the addition, alteration and improvement work of the existing systems.

**1.3.2** This Code of Practice shall be read in conjunction with any additional recommendations provided by suppliers / manufacturers of the cooling tower system equipment as well as relevant ordinances and regulations in Hong Kong.

**1.3.3** EMSD reserves the right to interpret the contents of this Code of Practice.

**1.3.4** In case of conflict between the requirements of this Code of Practice and any other requirements, the following order of priority shall apply:

- a) All currently in force Legislation and other Subsidiary Legislation.
- b) The relevant Codes of Practice and Technical Standards.
- c) This Code of Practice.

## 2. Cooling Tower Types and Cooling Tower Systems

### 2.1 General

Proper design of cooling tower system helps in reducing operational and maintenance problems as well as environmental impacts arising from system operation.

### 2.2 Cooling Tower Types

2.2.1 In general, cooling towers are classified based on their construction and air movement through the cooling tower in relation to the falling water droplets. Both natural draft and mechanical draft cooling towers are available in the market. Natural draft cooling towers do not use a mechanical air-moving device and all air movement through the cooling towers relies on the wind and stack effects. Mechanical draft cooling towers make use of mechanical fans to force ambient air flowing through the cooling towers.

2.2.2 There are two basic types of evaporative cooling towers, namely direct-contact and indirect contact.

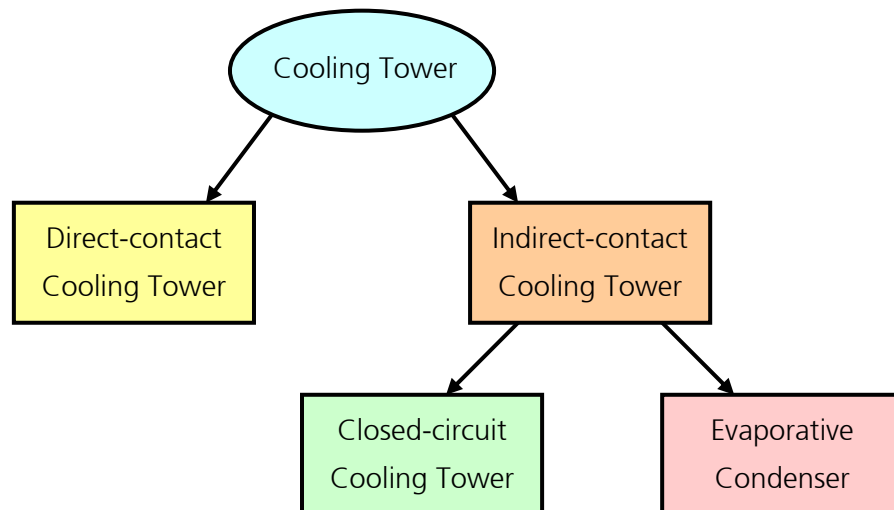

Figure 1.1: Classification of cooling tower

### 2.2.3 Direct-contact cooling tower

Direct-contact cooling tower exposes water directly to the cooling atmosphere, hence transfers the heat from the cooling water directly to the air. Direct contact cooling towers can be further classified by their components' configuration and air draft mechanisms. In general, there are four different types:

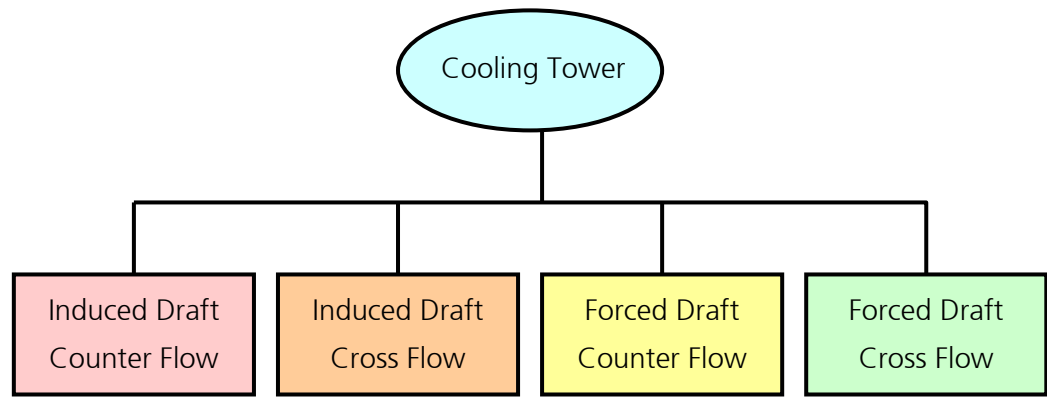

Figure 1.2: Types of cooling towers

a) **Induced Draft Counter Flow Type**

Fan is installed inside cooling tower, which induces air to flow through louvre openings, pass through the fill and discharge through the fan. The fan pulls air up through the tower in the opposite direction to which the water is falling. Water is usually delivered by means of fixed or rotating spray arms. Drift eliminator is usually placed above the sprays to prevent loss of water through drift. This type of cooling tower can handle large heat rejection loads. Therefore, it is suitable for larger cell size and fan size. Larger fan size operating at low speed may result in greater efficiency and consequently lower power and sound levels. Typical configuration of induced draft counter flow cooling tower is shown in Figure 1.3.

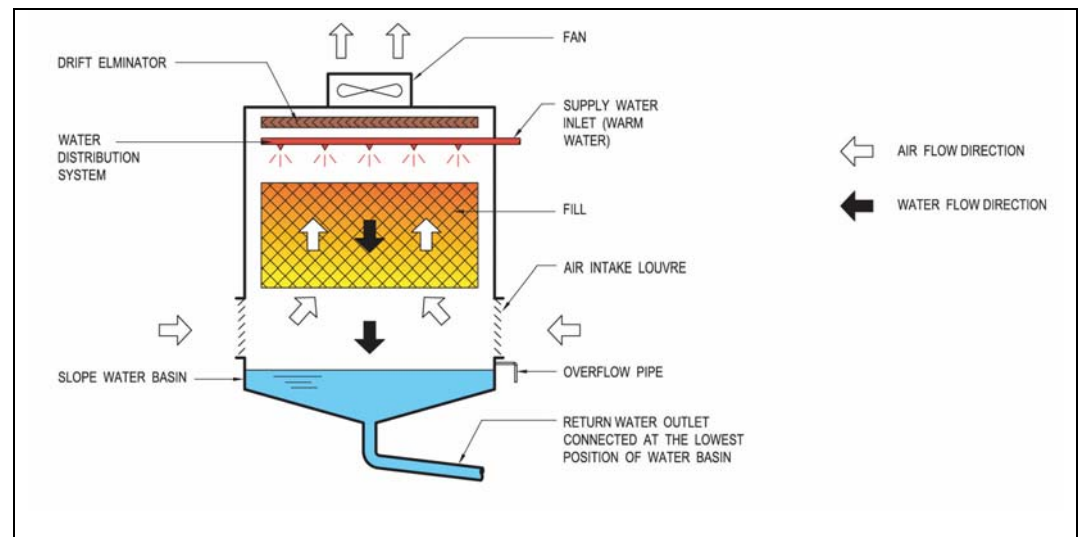

Figure 1.3: Typical configuration of induced draft counter flow cooling tower

b) **Induced Draft Cross Flow Type**

Fan is used to create an induced air flow into the cooling tower. Air is drawn or induced across the water falling from the top of the tower to the basin. This tends to give a more evenly distributed air flow through the fill, when compared with the



forced draft design. Drift eliminator is installed vertically along the fill. Figure 1.4 illustrates the typical configuration of induced draft cross flow cooling tower.

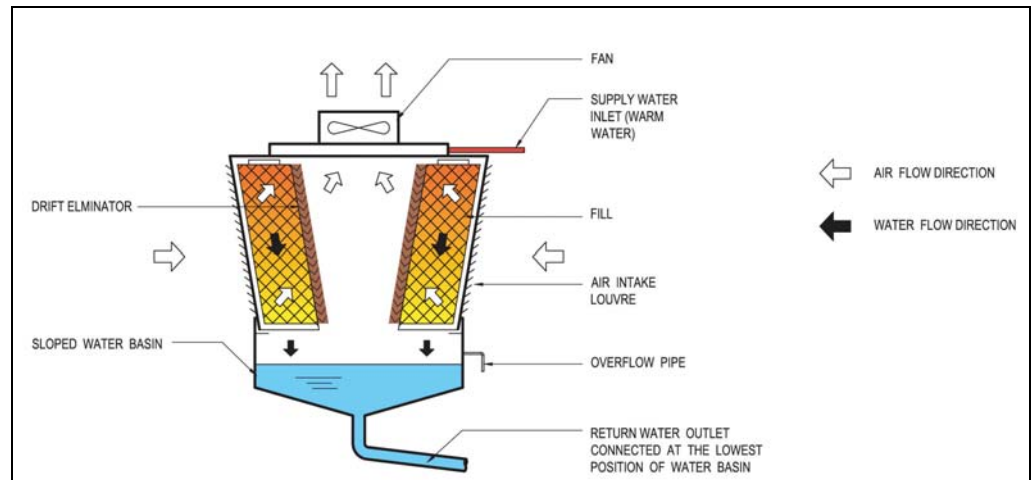

Figure 1.4: Typical configuration of induced draft cross flow cooling tower

c) **Forced Draft Counter Flow Type**

Fan is generally mounted at low level (inlet air side) of the cooling tower so that air can be forced upward through the fill. Axial or centrifugal fans can be used depending on external static pressure requirement and noise limit. Water sprays from the top of the cooling tower, which is in opposite direction to the air flow. Fan installed at low level tends to reduce the overall height of the tower and generate low vibration due to rotating components being located near the base of the tower. Fan unit is placed in a comparatively dry air stream; this reduces the problem of moisture condensing in the motor or gearbox. Figure 1.5 shows the typical configuration of forced draft counter flow cooling tower.

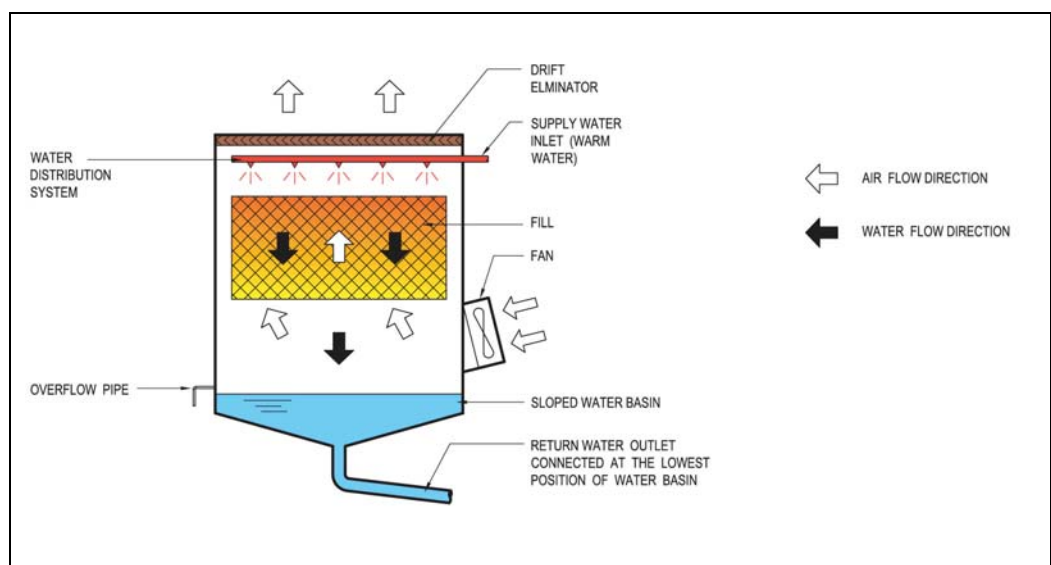

Figure 1.5: Typical configuration of forced draft counter flow cooling tower

d) **Forced Draft Cross Flow Type**

Fan is mounted on one side and air is forced through the fill horizontally with drift eliminators on the outlet side. This type of cooling tower is suitable for restricted headroom and low heat rejection capacity. Typical configuration of forced draft cross flow cooling tower is shown in Figure 1.6.

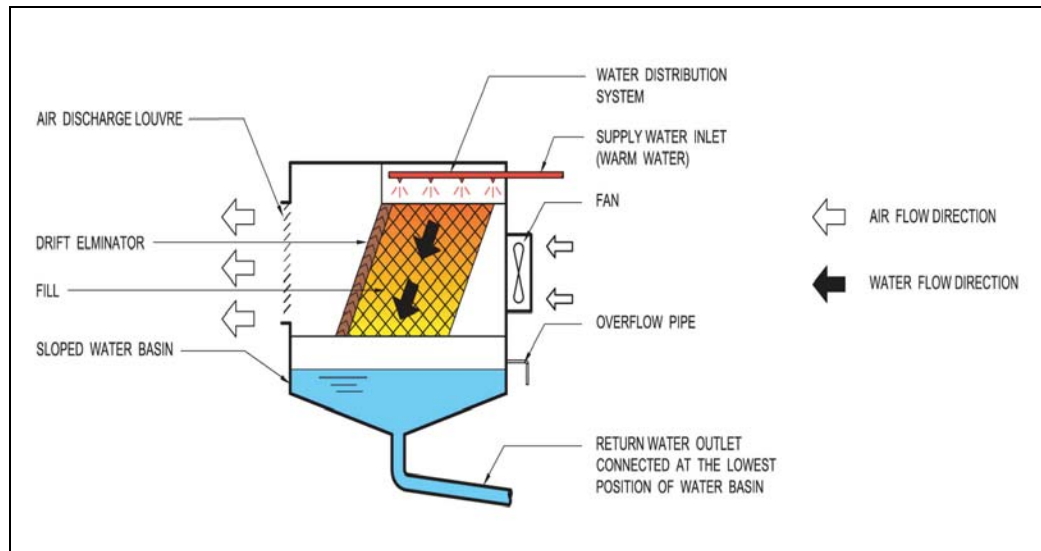

Figure 1.6: Typical configuration of forced draft cross flow cooling tower

2.2.4 **Indirect-contact cooling tower**

Indirect-contact cooling tower involves indirect contact between the fluid being cooled and the atmosphere, essentially combining a heat exchanger and cooling tower into one relatively compact device. Both closed-circuit cooling tower and evaporative condenser are classified as indirect-contact type. The indirect-contact cooling towers, according to their fan configurations, can also be classified as induced draft counter flow, induced draft cross flow, forced draft counter flow and forced draft cross flow cooling towers. Unlike direct-contact cooling towers, this type of cooling tower does not contain fill material.

a) **Closed-circuit Cooling Tower**

There are two separate fluid circuits in a closed-circuit cooling tower. One circuit allows water exposed to the ambient, while another circuit consists of tubes carrying fluid to be cooled. Heat flows from the one fluid circuit, through the tube walls to another water circuit. Heat is then transferred to the atmospheric air. Figure 1.7 shows the typical configuration of closed-circuit cooling tower.

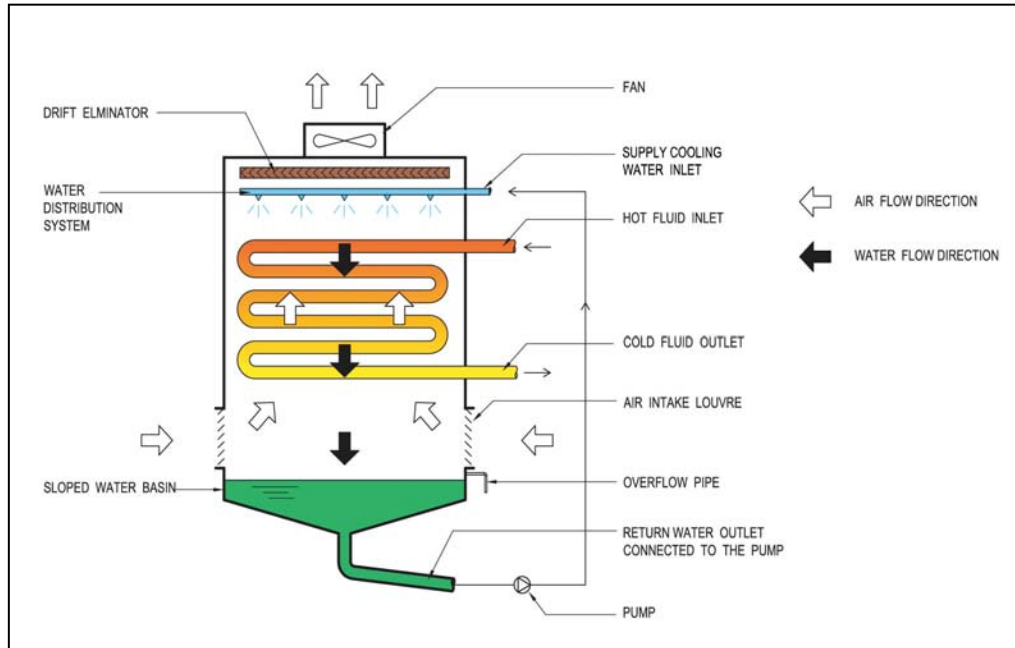

Figure 1.7: Typical configuration of closed-circuit cooling tower

b) **Evaporative Condenser**

The working principle of evaporative condenser is very similar to a closed-circuit cooling tower, except that the refrigerant entering the tubes is in vapour state, which is then cooled by the falling water. Vapour is condensed to liquid state by releasing heat to the falling water. Figure 1.8 illustrates the typical configuration of evaporative condenser.

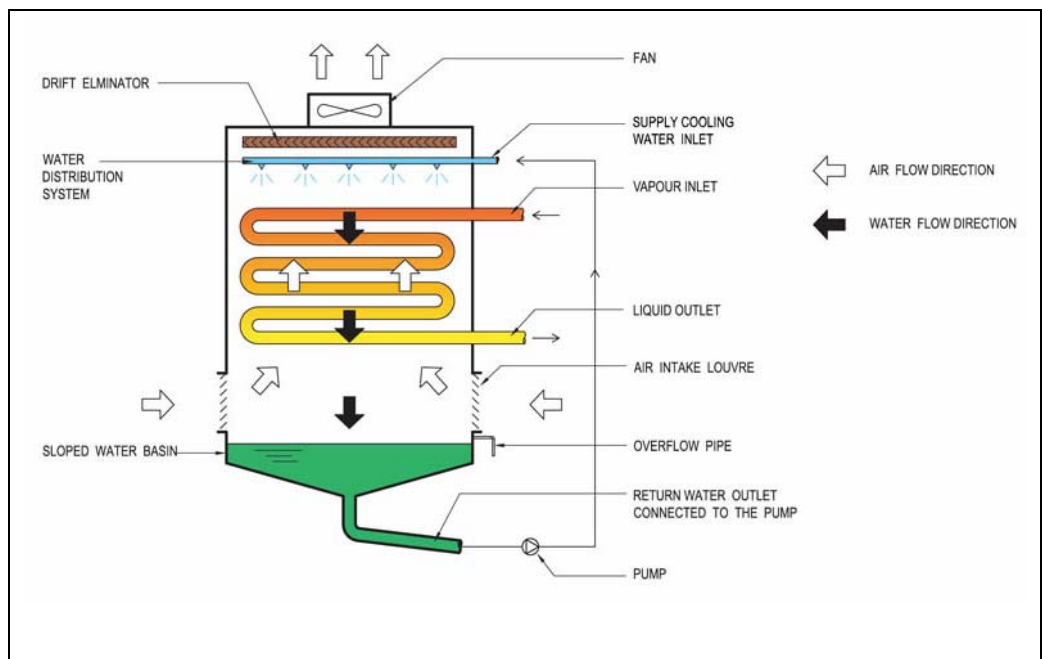

Figure 1.8: Typical configuration of evaporative condenser

## 2.3 Cooling Tower System

2.3.1 A typical cooling tower system consists of cooling tower, chiller condenser / heat exchanger, water pump, chemical water treatment equipment, physical water treatment equipment, make-up water tank, bleed-off and drainage, pipework and fittings, metering devices, etc. Major components commonly found in the system are shown in Figure 1.9 and elaborated in the following section.

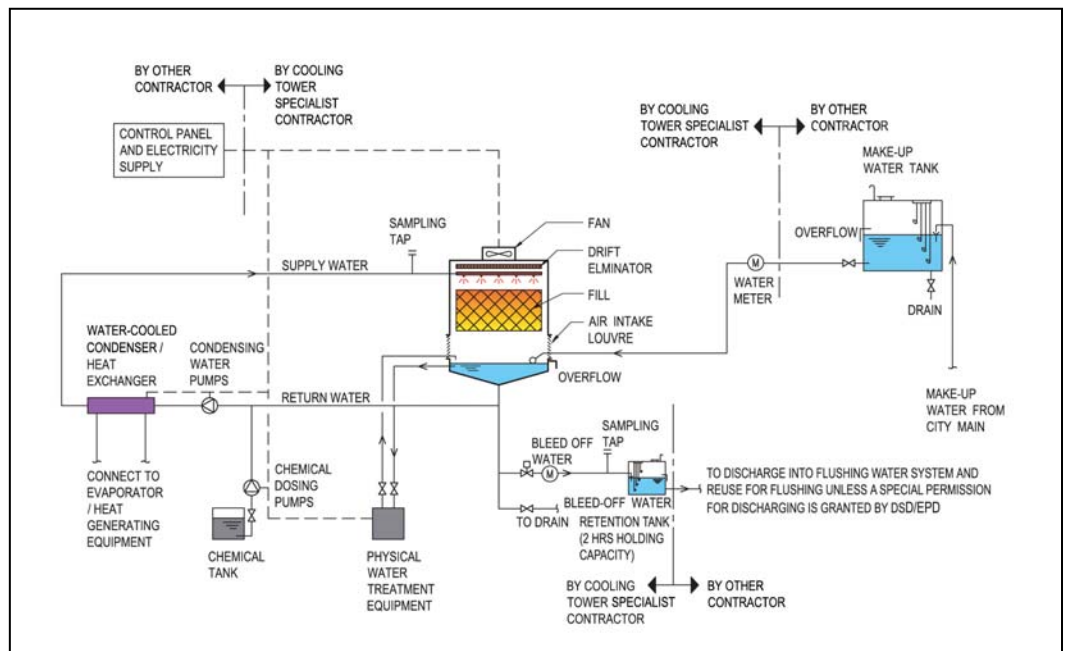

Figure 1.9: Schematic diagram for typical water-cooled air conditioning system

- 2.3.2 Fresh water from the mains is commonly adopted by the cooling tower system. But in some cases, seawater can also be used as the cooling water.
- 2.3.3 Water pump(s) is installed for circulating water between the cooling tower and the condenser. Equalising pipe shall be provided for multiple cooling tower installation to prevent overflow of cooling tower water from water basins.
- 2.3.4 Make-up water is required to compensate water losses due to evaporation, drift and bleed-off. Make-up water tank shall be located at a level higher than the water inlet of cooling tower; otherwise, booster pump is required to provide sufficient static head for make-up water.
- 2.3.5 Water treatment systems, whether chemical or physical, are essential for a cooling tower system. They shall be applied to tackle the problems of corrosion, scale and micro-organism growth, hence to enhance cooling tower water quality. Details

shall refer to the Code of Practice for Water-cooled Air Conditioning System: Part 3 – Water Treatment Methods for Cooling Towers.

- 2.3.6** Water meters may be installed to record the total water consumption and the bleed-off of cooling tower. The make-up water consumption profile is a reasonable indicator to monitor any abnormal operational conditions of cooling tower.
- 2.3.7** Energy meter may be installed to measure the energy consumption by the entire cooling tower system. This gives information to the system owner and property manager regarding the monthly cumulative energy consumption, which is used to compare the trend and identify any abnormal operation.
- 2.3.8** Provision of cleansing water point near cooling tower is recommended to facilitate cleaning of cooling tower.

### **3. Cooling Tower Construction and Installation Requirements**

#### **3.1 Cooling Tower Shell**

**3.1.1** Cooling tower shell is the external jacket of a cooling tower that attaches to the cooling tower framework. It is the structural component to ensure rigidity and integrity of cooling tower.

**3.1.2** Cooling tower shell shall be robust and constructed from non-corrosive and rigid material. It shall not foster microbiological growth nor react adversely with water treatment, cleaning, disinfection and decontamination chemicals. The shell shall withstand cooling tower structural load from internal components, including fill, framework, water basin as well as fan operation load, wind load and water pressure load. Also, it shall structurally support the attachment of maintenance platform and ladders, as well as maintenance staff load.

**3.1.3** Since cooling tower is usually installed outdoor, the casing shall be weather resistant and opaque to sunlight. If cooling tower is installed indoor, fire-retarded material complying with the local fire services requirements shall be used. All materials in the cooling tower system shall be compatible to each other and shall not deteriorate rapidly in a warm and moist environment.

**3.1.4** Where feasible, cooling tower should be constructed, assembled and carried out performance test in the factory before delivered to site.

#### **3.2 Intake Louvre**

**3.2.1** Intake louvre forms part of the cooling tower shell, which is used to retain circulating water and equalize air flow into the cooling tower.

**3.2.2** Intake louvre shall be designed to prevent water from spilling out and to obstruct direct sunlight from entering the cooling tower basin to minimize the growth of algae. For cross flow type cooling towers, two pass superior air inlet louvre screens constructed with corrosion free material can further eliminate water splashing out. Similar to cooling tower shell, material used shall be weather resistant and opaque to sunlight. Fire-retarded material complying with the local fire services regulations shall be used for cooling towers installed indoor.

**3.2.3** In order to attenuate the noise emitted from cooling tower, acoustic louvres can be installed where necessary.

### **3.3 Fill**

**3.3.1** Fill is a major component in cooling tower to enhance heat and mass transfer and shall be designed to provide maximum surface area for heat transfer process as the efficiency of cooling tower depends on the contact surface arrangement and contact time between air and water.

**3.3.2** Fill must promote air-water contact while imposing the least possible restriction to air flow. Material used for fill shall be durable, inert to chemical attack and fire retarded. Fills shall also be designed to facilitate cleaning and do not support bacteria growth.

### **3.4 Fan and Fan Motor**

**3.4.1** Fan is used to force or to draw air to pass through the tower with an electric motor as the drive. Either axial fan or centrifugal fan can be used in cooling tower depending on the system configuration and other technical requirements.

**3.4.2** Cooling tower fan shall have sufficient static pressure to encounter the internal static pressure and additional pressure drop due to silencer or deflector.

**3.4.3** Fan blades shall be set to the same pitch to avoid unbalanced aerodynamic forces. Since fan is operated in moisture-laden atmosphere, all materials shall be corrosion resistant. If gearbox is equipped for the fan, it shall also be waterproof to prevent the incursion of cooling water.

**3.4.4** Fan motor shall be of water-proof type and operate under high humidity condition. Two-speed motor is recommended to allow cooling tower fan speed to be varied in responding to different heat rejection load. Also, motor insulation must withstand thermal aging, moisture, expansion and contraction stresses, electrical stress, mechanical vibration and shock.

### **3.5 Water Basin**

- 3.5.1** Water basin is located at the bottom of cooling tower to collect all cooled water from the tower; therefore, it is in contact with water all the times once the cooling tower is in operation.
- 3.5.2** In order to prevent accumulation of dirt and particulates, the basin must be smooth, without dirt trapping pattern, accessible, cleanable, provided with adequate drain facilities and screening equipment. Materials used for basin shall be non-corrosive, rigid and easy to clean.
- 3.5.3** Basin shall be watertight and has adequate fall to allow water flowing to the drain point. Drainage outlet size depends on capacity of cooling tower, but shall not be less than 50 mm of internal diameter, and shall be provided at the lowest point of the basin to facilitate complete drain.
- 3.5.4** Basin shall have sufficient water depth of at least two velocity head measured above the top level of water outlet in order to prevent vortex forming at the water outlet and inducing excessive quantities of air. Alternatively, anti-vortex plate, sparge pipe or large diameter outlet may be used to reduce velocity below the free surface.
- 3.5.5** Screen shall be installed at the bottom level of the sump to filter large impurities, such as leaves, so as to prevent blockage of the pump. Installation of side-stream filtration is a good practice to allow cleaning during continuous operation.
- 3.5.6** Condenser water pipework above the level of the basin shall be kept to a minimum to avoid air ingress and loss of water when system is temporarily shut down.

### **3.6 Drift Eliminator**

- 3.6.1** Drift eliminator removes entrained water from the discharged air by allowing air to have sudden changes in direction. The resulting centrifugal force separates the water droplets from the air, lets the water droplets attach to the eliminator surface and allows them to return to the cooling tower basin.
- 3.6.2** Efficiency of drift eliminator depends on the number of directional airflow changes, spacing between the blade surface, angle of directional change and the capability of drift eliminator blade to return the collected water to a quiescent area of the



plenum. Drift eliminators can be characterised by their shapes and configuration. Common types of drift eliminators include cellular (honeycomb), herringbone (blade-type) and waveform.

- 3.6.3** Drift eliminator shall be provided and installed in each cooling tower to facilitate ease of inspection, cleaning and maintenance. It shall be extended across the air stream without air bypass. Drift eliminator shall be made from materials with good corrosion resistance. It shall be durable and can withstand cleaning by water jet.
- 3.6.4** Drift eliminator shall be effective at the air velocity prevailing when the cooling tower is in operation. Attention shall be paid to ensure drift eliminator is well seated and fixed closely against one another with no gaps where the air stream can bypass the baffle.
- 3.6.5** Drift emission of the drift eliminator installed in cooling tower shall not exceed **0.005%** of the maximum design water circulation rate through the cooling tower. Drift emission test shall be carried out under design maximum air flow and maximum water flow conditions of the drift eliminator being tested. A test certificate or supporting documents, which clearly states the test method and the testing conditions, shall be provided to prove the performance of the drift eliminator under the specified testing conditions.
- 3.6.6** The drift loss performance of the drift eliminator shall remain at its design level within its life cycle.

### **3.7 Water Distribution Pipework**

- 3.7.1** Gravity-flow distribution and pressure-type system are two common water distribution systems used inside cooling tower. Gravity-flow distribution consists of distribution plate with closely and evenly separated orifices. Water is turned into small droplets when flowing through the orifices and distributes to the fill. Pressure-type system consists of pipes and spray nozzles, which generate a water spray pattern to allow water spray evenly passing over the fill.
- 3.7.2** In order to prevent formation of algae due to direct sunlight, cooling tower adopting water distribution system shall be covered by ultra-violet resistant materials. Materials used for pipes, spray nozzles and distribute plates shall be rigid, corrosion resistant and do not proliferate bacteria growth.

### **3.8 Water Circulation Pipework**

- 3.8.1** Cooling tower water circulation system pipework shall be designed to avoid dead-leg and stagnant corners. Simple pipework design shall be adopted. If the installation involves more than one cooling tower, balance pipe between the cooling towers shall be provided.
- 3.8.2** If the existence of dead-leg cannot be avoided, mitigation measures for dead leg shall be provided, such as installation of manual / automatic drain valve for periodic drain off.
- 3.8.3** Provision of recirculating pump controlled by a timer to circulate water through the system periodically (at least once a week) is recommended when cooling towers are temporary not in use. Purge valve installed at end of pipe riser can avoid stagnant water as well.
- 3.8.4** Drain pipe with manual / automatic on / off valve shall be provided to each cooling tower for routine cleaning and emergency decontamination.

### **3.9 Water Sampling Point**

- 3.9.1** In order to facilitate water sampling, sampling tap shall be fitted at the pipework where the warmed water enters the cooling tower. The pipework of the sampling tap shall not be excessively long and shall be positioned as close to the main pipe as possible so as to avoid the problem of dead leg.
- 3.9.2** Water sampling tap can also be located at the cooling water return line, but not adjacent to water inlets, dosing points or bleed-off positions.

### **3.10 Deflector**

Deflector is to divert exhaust air to a specific direction. It is recommended to install deflector on cooling tower located in the area, where the exhaust from cooling tower may directly affect the adjacent air intakes and openings, create a short-circuit problem of cooling tower air flow or cause nuisance to nearby sensitive receivers.

### **3.11 Silencer**

Silencer shall be provided if the noise emitted during operation of cooling tower exceeds the limit stated in the Noise Control Ordinance and Technical Memorandum for the Assessment of Noise from Places other than Domestic Premises, Public Places or Construction Sites issued by EPD.

### **3.12 Plume Abatement Device**

Plume abatement device can be installed to minimize the plume caused by the condensation of the discharged air from cooling tower if the plume is considered as nuisance to the surroundings.

### **3.13 Access Opening**

Access door with minimum dimensions of 600mm (width) × 1000mm (height) is recommended for cooling tower to facilitate inspection and maintenance of inner part of the tower. If no access door is provided due to tower construction constraints, easy dismantle of cooling tower shell shall be allowed for maintenance work.

### **3.14 Cooling Tower Structure**

The structure of cooling tower must accommodate dead loads imposed by the weight of cooling tower and circulating water, as well as wind load and maintenance load. It must maintain its integrity throughout a variety of external atmospheric conditions. Overall cooling tower weight shall be taken into account in the design of the building structure.

### **3.15 Ladder and Handrail**

Ladder and handrail shall be provided to facilitate routine cleaning, maintenance and inspection. Cooling tower shall be equipped with maintenance platform with toe board, ladders and permanently fixed access to the level for carrying out normal maintenance. Sufficient safety provision is required if maintenance work is potentially to be carried out at high level.

### **3.16 Installation Access**

Cooling tower installation shall be designed to allow easy and safe access for routine cleaning, water sampling, inspection and maintenance.

### **3.17 Cooling Tower Supporting Framework**

The supporting frame for cooling tower and similar installations are building works subject to compliance with Buildings Ordinance, and prior approval and consent must be obtained for construction. The frame should not affect lighting and ventilation and not to project over streets. Authorised Person shall submit plans for approval and consent application prior to the commencement of the works. Upon completion, the Authorised Person is required to certify the works are completed in accordance with the plans approved by the Building Authority and the works are structurally safe.

The supporting plinth of cooling tower shall refer to manufacturers' recommendation in order to prevent deformation due to incorrect plant load.

**4. Cooling Tower Installed Location**

**4.1 General**

**4.1.1** Cooling towers shall be installed in a location that will not create nuisances to the third party (including the occupants inside a building and the surroundings). The works of cooling towers shall be in full compliance with the Buildings Ordinance.

**4.1.2** If cooling tower is located at flat roofs, podium roofs and open areas, etc., it should not affect the floor loading, natural lighting and ventilation, refuge areas, escape access to alternate staircases and be of no contravention of the Buildings Ordinance.

**4.1.3** The minimum horizontal separation measured from the cooling tower exhaust and cooling tower intake to the nearest outdoor air intake, exhaust air outlet and operable window shall comply with the separation requirements as shown in the following table.

	Outdoor air intake (m)	Exhaust air outlet (m)	Operable window (m)
Cooling tower exhaust	7.5	7.5 (Note)	7.5
Cooling tower intake	5	7.5	5

Note: This separation distance shall be applied if the exhaust air outlet is a natural outlet.

Table 1.1: Minimum horizontal separation distance from cooling towers

**4.1.4** No pedestrian thoroughfare, area of public access, or place where people gather together for activities shall be located within 7.5m from the cooling tower exhaust or from any point of the cooling tower.

**4.1.5** If the exhaust air from a cooling tower system discharges towards a louvre or an opening, a deflector or an air ductwork shall be provided to divert the exhaust air from cooling tower to an appropriate direction.

**4.1.6** If the cooling tower is installed outdoor with an extended ductwork for exhaust air, the measurement is from the exhaust termination of the ductwork, as well as from any point of the cooling tower. If the cooling tower is installed indoor with an

extended ductwork for exhaust air, the measurement is from the exhaust termination of the ductwork.

- 4.1.7** The prevailing wind condition shall be considered to determine if the cooling tower exhaust will create nuisance to the third party (including the occupants inside a building and the surroundings).

## **4.2 Cooling Towers installed on Building Roof**

- 4.2.1** Cooling tower installed on building roof shall maintain adequate separation from the nearest outdoor air intake, exhaust air outlet, operable window, public thoroughfare, area of public access as stipulated in Clauses 4.1.3 and 4.1.4, so that the drift and air emitted from the cooling tower(s) will not enter the building through the outdoor air intake and operable window or the exhaust air from the building will not become the cooling air for the cooling tower.

- 4.2.2** The diagrams illustrating the distance of separation are shown in Figure A1 in Appendix 1A.

## **4.3 Cooling Towers installed on Podium Roof**

- 4.3.1** Cooling tower installed on podium roof is possibly to be surrounded by residential blocks, which may affect the air flow pattern and dispersion of drift within that region. Therefore, cooling tower location shall be carefully selected so that exhaust air, drift and plume generated from cooling tower would not cause nuisance to the residents.

- 4.3.2** Cooling tower installed on podium roof shall maintain adequate separation from the nearest outdoor air intake, exhaust air outlet, operable window, public thoroughfare, area of public access as stipulated in Clauses 4.1.3 and 4.1.4, so that the drift and air emitted from the cooling tower(s) will not enter the building through the outdoor air intake and operable window or the exhaust air from the building will not become the cooling air for the cooling tower.

- 4.3.3** In all cases, cooling tower exhaust air shall be discharged away from building operable windows and outdoor air intakes.

- 4.3.4** The diagrams illustrating the distance of separation are shown in Figure A2 in Appendix 1A.

#### **4.4 Cooling Towers installed in Indoor with Vertical Discharge through Roof or Horizontal Discharge through Side Wall**

**4.4.1** Cooling towers if located indoor shall be installed in a designated plant room. The plant room shall not be accessed from occupied area directly. The fire resisting construction for cooling tower plant room and penetrations of associated pipework / ductwork through fire resisting walls/slabs shall be in full compliance with the Buildings Ordinance.

**4.4.2** Sufficient fresh air shall be provided to maintain normal operation of cooling tower systems.

**4.4.3** For cooling tower with vertical discharge through roof or horizontal discharge through side wall, the minimum horizontal separation from the cooling tower exhaust to the outdoor air intake, operable window, public thoroughfare and area of public access shall meet the requirements as stipulated in Clauses 4.1.3 and 4.1.4.

**4.4.4** The diagrams illustrating the distance of separation are shown in Figure A3 to Figure A6 in Appendix 1A.

#### **4.5 Cooling Towers installed at Other Locations**

When the cooling tower is installed at the locations other than those specified in Clauses 4.2, 4.3 and 4.4, thorough assessment shall be carried out on the location selected. The assessment shall include, but not limited to, the separation distance between the cooling tower and the nearest building and its outdoor air intake, the quality of intake air, the direction of cooling tower exhaust air, the prevailing wind direction and other environmentally related factors.

#### **4.6 Minimum Separation between Cooling Towers**

Separation between cooling towers installed adjacent to each other shall refer to technical recommendations provided by cooling tower manufacturers. The minimum separation shall be kept in order to ensure the thermal performance of cooling towers is not affected. If there is no recommendation given by the manufacturer, the minimum separation distance shall not be less than the lateral width of the cooling tower.

#### **4.7 Minimum Separation from Physical Barrier**

Obstruction of fresh air intake for cooling tower may have adverse influence to heat rejection performance. Minimum separation requirement between cooling tower and physical barrier as recommended by cooling tower manufacturers shall be followed. If there is no recommendation given by the manufacturer, the minimum separation distance shall not be less than the lateral width of the cooling tower.

#### **4.8 Installed Location not fulfilling the Required Minimum Separation**

The requirements of minimum separation as specified in the Clauses 4.1.3 and 4.1.4 of this CoP shall be satisfied in normal circumstance. In the event that the specified minimum separation stipulated in the CoP cannot be met, alternative mitigation measures can be provided by system owner / designer to minimize any potential risk with substantiation for consideration. Computational Fluid Dynamics (CFD) simulation may be used to assist in providing justification in critical case.



## **5. Cooling Water and Bleed-off Water Control**

### **5.1 Cooling Water Quality Control**

#### **5.1.1 General**

Good cooling water quality of cooling towers can minimize scaling and biofouling problems such that effective heat exchange in condenser / heat exchanger can be maintained. The Part 3 of this Code of Practice provides details of water treatment for cooling towers.

#### **5.1.2 Cooling water quality**

- a) Fresh water and seawater type cooling tower system shall be properly designed to achieve the relevant water quality targets as described in the tables in the Part 2 of this Code of Practice as far as practicable. More precise levels shall be advised by water treatment services providers.
- b) Quality of cooling water discharged from cooling tower systems shall comply with the requirements stipulated in the EPD's Technical Memorandum on Standards for Effluent Discharged into Drainage and Sewerage Systems, Inland and Coastal Waters. It should be noted that the effluent discharge requirement may vary with the discharge flowrate.

### **5.2 Bleed-off Control and Re-use of Bleed-off Water**

#### **5.2.1 General**

Bleed-off is required to maintain the concentration of total dissolved solids (TDS), insoluble precipitates, other chemical constituents and pH value of cooling tower at an acceptable level. Bleed-off is preferred to be performed automatically. Automatic bleed-off can be controlled by conductivity sensor or timer controlled drain valves. Bleed-off immediately after chemical dosage shall be avoided to minimize chemicals wastage. Manual bleed-off is not preferred unless automatic bleed-off is not practicable.

#### **5.2.2 Bleed-off water quantity**

In order to prevent water wastage, the minimum cycle of concentration in designing water treatment program and bleed off requirement shall not be less than 6 and 2 for fresh water and seawater cooling tower system respectively. Drainage system shall be designed based on the estimated bleed-off quantity.

**5.2.3 Bleed-off water quality**

The quality of bleed-off water from cooling tower shall satisfy the standard specified in the Technical Memorandum on Standards for Effluent Discharged into Drainage and Sewerage System, Inland and Coastal Waters issued under the Water Pollution Control Ordinance. Other standards that are set for toxic metals shall also be complied with.

**5.2.4 Re-use of bleed-off water**

- a) The bleed-off water from cooling tower shall be reused for flushing purpose by discharging it to a retention tank before transferring it to the flushing water tank or discharging it directly to the flushing water tank by gravity. If a retention tank is used, its capacity shall be designed to store bleed-off water discharged by the cooling tower of not less than two hours of operation. If bleed-off water is directly discharged to the flushing water tank, adequate capacity in the flushing water tank shall be reserved to prevent overflowing. In both cases, the bleed-off water shall be prioritized to refill the flushing tank.
- b) Some WSD’s quality requirements for flushing water are shown in Table 1.2. If the bleed-off water quality is found exceeding the stated water quality objectives as listed in the Table 1.2, the flushing water at distribution shall be regularly checked and closely monitored for compliance. The bleed-off water may be treated when necessary to achieve the stated water quality objectives for flushing supply at distribution.

Parameters (Part)	Water Quality Objectives for Flushing Supply at Distribution
Suspended Solids (mg/L)	< 10
Dissolved Oxygen (mg/L)	> 2
5-day Biochemical Oxygen Demand (mg/L)	< 10

Table 1.2: Some water quality objectives for flushing supply at distribution

**5.2.5 Bleed-off water directly discharged to public sewage system**

Direct discharge of bleed-off water should not be made to the public sewage system in the physical arrangement. The owner / designer of the cooling tower system shall submit an application for not reusing bleed-off water for flushing to the satisfaction of the relevant authorities in order to obtain a special permission. In case the bleed-off water is not reused for flushing, wholly or partially, a retention

tank may be required to be installed to withhold the bleed-off water for discharge to the public sewers at the time to be agreed by the relevant authorities.

#### **5.2.6 Considerations of not re-using of bleed-off water for flushing**

Cooling tower owner / designer may consider the water quality, the water treatment methods, the usage of the building, the flushing water demand and other factors to determine the suitability of re-using bleed-off water for flushing purpose.

## 6. Notices and Labels

- 6.1 All cooling towers, water treatment equipment, water tanks and pipeworks shall be properly labeled to provide clear indication for operation and maintenance personnel.
- 6.2 Warning signs shall be erected to alert operation and maintenance personnel of the potential hazard caused by cooling tower.
- 6.3 Warning signs shall also be erected to restrict unauthorised access to cooling towers.
- 6.4 Labels and signs shall be durable and securely fixed / marked on the following location:
- a) Outside cooling tower apparatus area / room;
  - b) Outside chiller plant and condensing water pump area / room;
  - c) Make-up pipe;
  - d) Bleed-off pipe;
  - e) Condensing water supply & return pipe;
  - f) Dead-leg purge valve;
  - g) Water sampling valve / tap;
  - h) Water treatment product handling area;
  - i) Cooling water quality control station;
  - j) Make-up condensing water tank;
  - k) Bleed-off water break tank; and
  - l) Flushing water tank.
- 6.5 The English and Chinese characters of the labels and signs shall be at least 8mm and 15mm high respectively.

## **7. Risk Management of a Cooling Tower System**

### **7.1 Installed Locations that required submission of Risk Management Plan**

If cooling tower system is installed in medical and health facilities such as hospitals, general clinics, specialist clinics; community support facilities for the elderly, such as residential elderly homes, social centre for the elderly; establishments providing health care and services for the sick and infirm; and any other premises which are considered necessary, a risk management plan for the cooling tower system shall be developed by the owner / designer of the cooling tower system.

### **7.2 Risk Management Plan**

**7.2.1** The risk management plan for the cooling tower system shall be prepared when designing the cooling tower system or whenever necessary. In developing risk management plan for complicated cooling tower systems, consultation with experienced system designers, cooling tower suppliers, cooling tower specialist contractors and occupational hygienists is suggested.

**7.2.2** The general guidelines for developing a risk management plan for a cooling tower system are shown below.

- a) To provide sit and key contact details of the cooling tower system.
- b) To identify, but not limited to, the following risk that are potentially found in a cooling tower system
  - Stagnant water
  - Nutrient growth
  - Poor water quality
  - Deficiencies in the cooling tower system
  - Location and access
- c) To assess the above risks if they are found in the respective cooling tower system.
- d) To recommend the mitigation measures if the above risks are found in the respective cooling tower system.

- e) To formulate an operational programme based on the above risk assessment results and recommended mitigation measures. The contents should at least include frequencies of inspection, service, cleaning, disinfection, HCC testing and Legionella testing.
- f) To provide a communication plan in case the cooling tower system is required to be attended urgently, such as positive Legionella testing results, complaints from the public, etc.
- g) To provide a procedure for monitoring and reviewing the RMP.

**7.2.3** Risk management plan shall be submitted along with the application to use cooling towers in the air conditioning system or whenever requested by EMSD.

**7.2.4** A typical risk management plan is shown in Appendix 1B for reference.

## **8. Testing and Commissioning of Cooling Tower Systems**

### **8.1 Testing and Commissioning**

Testing and commissioning of cooling tower shall be witnessed by a registered professional engineer (RPE) in building services engineering or mechanical engineering discipline. A sample checklist for testing and commissioning of cooling tower system can be referred to Appendix 1C.

### **8.2 Occupational Safety and Health**

**8.2.1** Sufficient personal protective equipment shall be provided to the personnel responsible to carry out testing and commissioning work of a cooling tower system. Recommended list of personal protective equipment required related to different job nature is shown in Appendix 1D.

**8.2.2** Eye wash bottles or washing basin with fresh water tap shall be provided adjacent to water treatment chemicals tanks or any appropriate location for emergency use. However, the water contained in the eye wash bottle shall be replaced periodically.

**8.2.3** Water treatment chemical shall be stored at an appropriate location to facilitate chemical handling.

**8.2.4** Mechanical / natural ventilation shall be provided to the room entirely / partially used for water treatment chemical storage.

**8.2.5** Electrical fittings and luminaries serving water treatment chemical storage area shall be weather-proof and corrosion resistant type.

## 9 Design and Commissioning Records

9.1 Formal design and commissioning records of a cooling tower system shall be kept by the cooling tower owner for the whole life of the system. The records shall be made available for inspections upon request by Government appointed officials. The record shall include, but not limited to the following:

- a) The name, contact phone and address of the owner of the cooling tower system;
- b) The name, contact phone and address of the cooling tower specialist contractor(s) (CTSC), who is responsible for the design, installation, testing and commissioning of the cooling tower system;
- c) Design details of the cooling tower system;
- d) Descriptions of the cooling towers and water treatment equipment, including their locations, technical specifications, models, capacities and year of manufacture / installation as well as correct operation procedure;
- e) Testing results of all equipment in the cooling tower system; and
- f) Water sampling results.

9.2 The operation and maintenance (O&M) manual of the cooling tower system shall be prepared by the cooling tower specialist contractor and kept by the cooling tower system owner. The O&M manual shall at least consist of the followings:

- a) Technical details of all equipment in a cooling tower system, including drawings of the plant, equipment and systems;
- b) System schematic and layout plan showing the locations of cooling towers and the nearby openings in the building and the adjacent buildings;
- c) Manufacturers' recommendations on operation and maintenance of all equipment in the cooling tower system;
- d) A programme for routine chemical treatment, cleaning, desludging and disinfection of the cooling tower;
- e) Details of water chemicals used for water treatment;
- f) Recommended cleaning methods and dismantling instructions; and
- g) Start-up, operating and shut-down procedures.



## 10 Qualification of System Designer

Water-cooled air conditioning system shall be designed by a registered professional engineer (RPE) in building services engineering or mechanical engineering discipline.

## 11 Reference Information

11.1 The following Ordinances, Technical Memorandum and Code of Practice shall be compiled with in the design, installation and commissioning of cooling towers:

- Waterworks Ordinance (WWO) (Cap. 102)
- Buildings Ordinance (BO) (Cap. 123)
- Sewage Services Ordinance (SSO) (Cap. 463)
- Water Pollution Control Ordinance (WPCO) (Cap. 358)
- Air Pollution Control Ordinance (APCO) (Cap. 311)
- Noise Control Ordinance (NCO) (Cap. 400)
- Occupational Safety and Health Ordinance (OSHO) (Cap. 509)
- Technical Memorandum on Standards for Effluent Discharged into Drainage and Sewerage System, Inland and Coastal Waters, EPD
- Technical Memorandum for the Assessment of Noise from Places other than Domestic Premises, Public Places or Construction Sites, EPD
- Pilot Scheme for Wider Use of Fresh Water in Evaporative Cooling Towers for Energy-efficient Air Conditioning Systems, EMSD
- Code of Practice for the Prevention of Legionnaires' Disease, HKPLDC

11.2 It is advised that designers should check other relevant statutory requirements and seek the professional advice from a Licensed Plumber, an Authorized Person (AP) and a Registered Professional Engineer (RPE) of building services or mechanical engineering disciplines when they have queries in the standard of work required.

### Minimum Separation Requirements for Cooling Towers

**Important Note:** The diagrams contained in this Appendix are not exhaustive illustrations for recommending the cooling tower installed location.

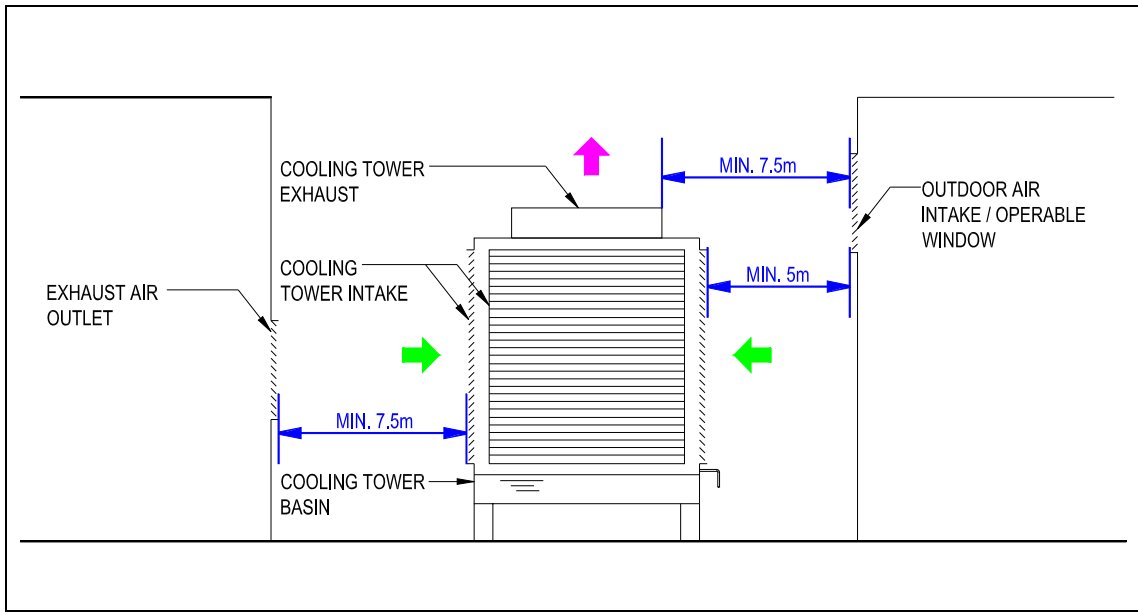

Figure A1: Minimum separation requirement for cooling towers installed on building roof

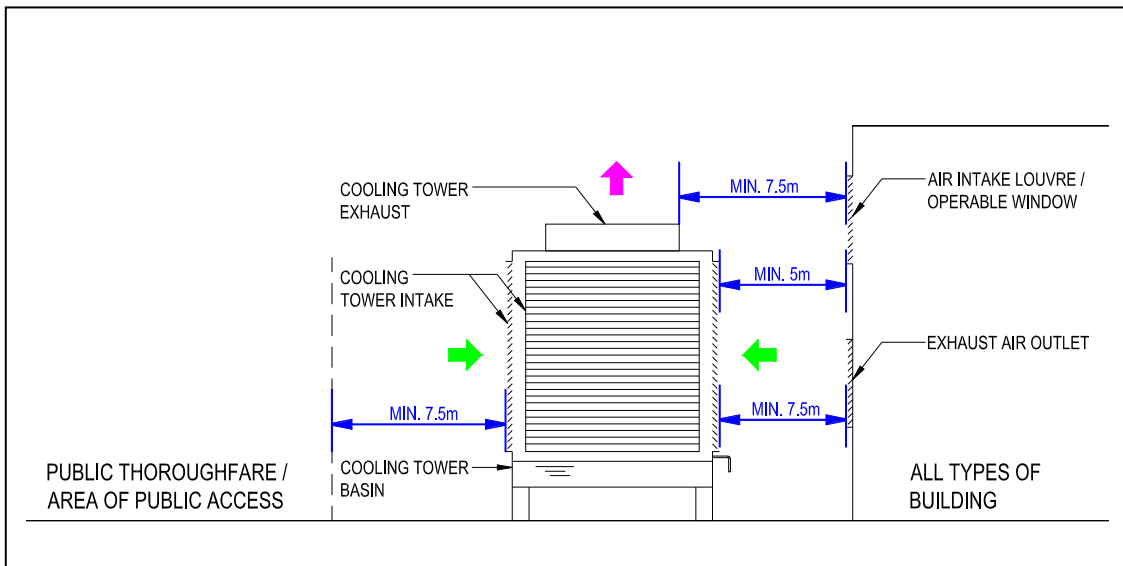

Figure A2: Minimum separation distance requirements for cooling tower installed on podium roof

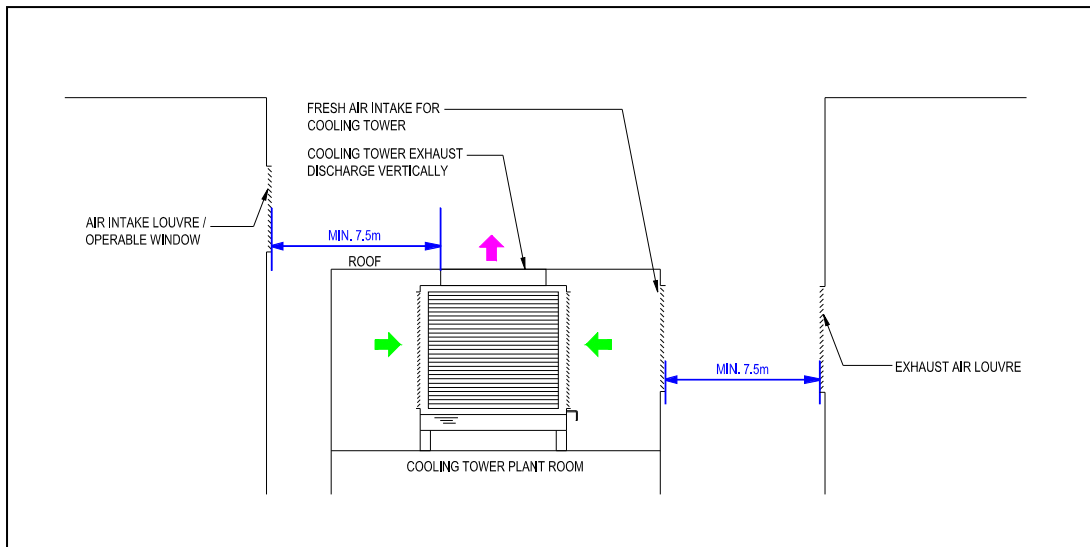

Figure A3: Cooling towers installed in indoor with discharge through roof

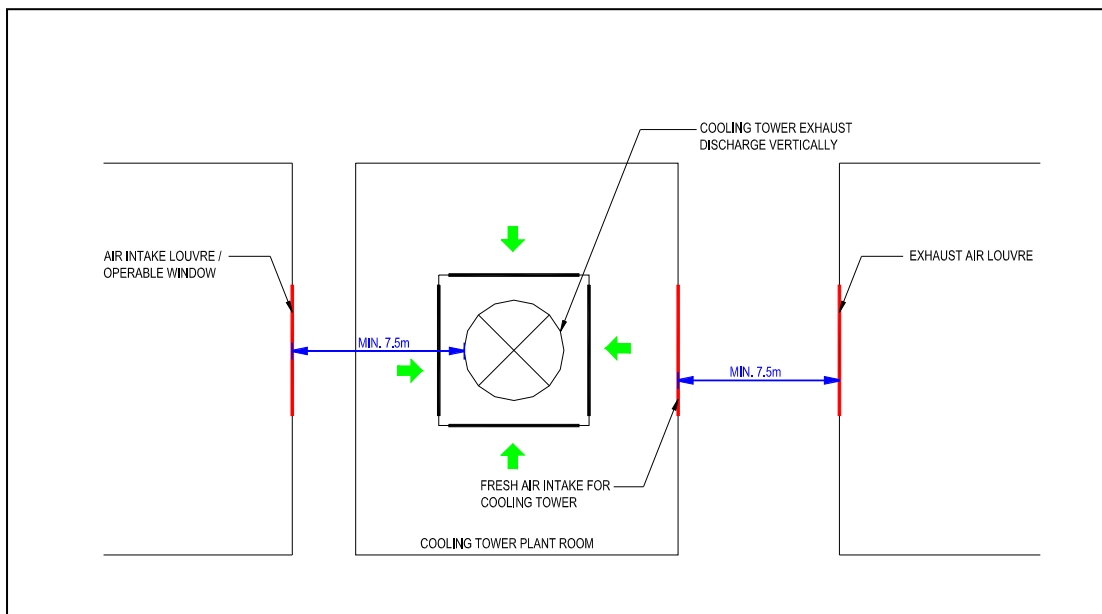

Figure A4: A plan view for Figure A3

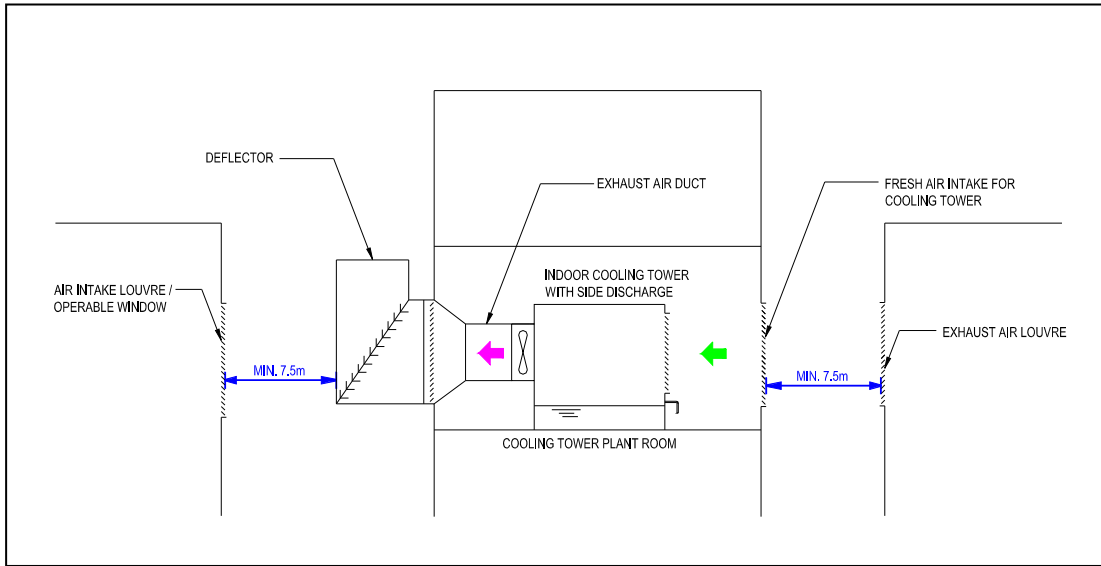

Figure A5: Cooling towers installed in indoor with discharge through side wall

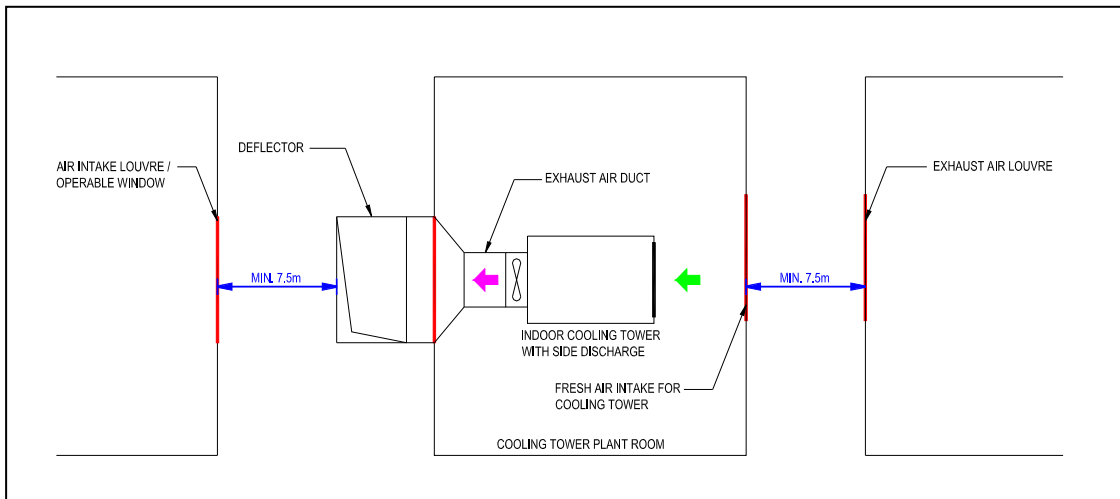

Figure A6: A plan view for Figure A5

## Typical Risk Management Plan for Water-cooled Air Conditioning System

### A. System Description

Record	Details
Building Name and Building Address	
Cooling tower type	
Number of cooling tower in system	
Heat rejection capacities of the cooling towers	
Building owner's name / contact details*	
Cooling tower owner's name and contact details*	
Cooling tower system designer's name and contact details*	

\* To include company name, contact person's business and after hours telephone numbers

### B. Major Risks – Location and Access

Types of Risk	Assessment	Mitigation Measures
Cooling tower system is located in / near an acute health or aged residential care facility		
Cooling tower exhaust creates nuisances to the public		
Cooling tower exhaust affects the intake and/or exhaust of nearby ventilation system		
Nearby air exhaust to supply nutrients for bacteria growth in cooling tower system (kitchen, toilet and carpark exhausts)		
Cooling tower surrounding area a pedestrian thoroughfare / a gathering place		
Potential danger to maintenance workers		

### C. Major Risks – Deficiencies in cooling tower system

Types of Risk	Assessment	Mitigation Measures
Drift emission from cooling tower		
Materials used support micro-organisms proliferation		
Failure of cooling tower system structure		

***D. Major Risks – Stagnant Water***

Types of Risk	Assessment	Mitigation Measures
Dead legs exist in water pipework		
Cooling tower(s) and associated pipework not in use for more than a month		

***E. Major Risks – Nutrient Growth***

Types of Risk	Assessment	Mitigation Measures
Contamination from surrounding area(s) (an increase of nutrients for bacteria growth in cooling tower system)		
Cooling tower’s wetted surfaces expose to direct sunlight (enhancing algae growth)		
Corrosion of system components		

***F. Major Risks – Poor Water Quality***

Types of Risk	Assessment	Mitigation Measures
HCC count		
Legionella Count		
Bleed-off water quality		
Malfunctioned chemical dosing system		

***G. Other Risks***

Types of Risk	Assessment	Mitigation Measures

## Sample Checklist for Minimum Testing and Commissioning Procedures of Water-cooled Air Conditioning Systems

Building Name : \_\_\_\_\_  
 Cooling Tower Designation : \_\_\_\_\_  
 Cooling Tower Type : \_\_\_\_\_  
 Manufacturer / Model No. : \_\_\_\_\_  
 Location : \_\_\_\_\_

### A. Physical Check

	Items	Accepted	Not Accepted
1.	General Condition of Unit		
2.	Cleanliness of basin		
3.	Fixing of Drift Eliminator		
4.	Fixing of Fill		
5.	Fans Rotation without Obstruction		
6.	Fan & Pump Motor for Proper Rotation		
7.	Noise / Vibration		
8.	Drive Alignment / Belt Tension		
9.	Other Components, Bolts, Fixing, etc.		
10.	Bearings Lubrication		
11.	Drainage & Fall		
12.	Strainer Cleanliness		
13.	Ball Valve Function		
14.	Tower Water Level		
15.	Water Distribution		
16.	Water Treatment Equipment		
17.	Electrical Supply Connection		
18.	Earth Bonding		

### B. Cooling Tower Thermal Performance Check

	Parameters	Unit	Design Data	Test Results
1.	Heat Rejection Capacity	kW		
2.	Air Flowrate	m <sup>3</sup> /s		
3.	Entering Air Dry Bulb Temperature	°C		
4.	Entering Air Wet Bulb Temperature	°C		
5.	Leaving Air Dry Bulb Temperature	°C		
6.	Leaving Air Wet Bulb Temperature	°C		
7.	Cooling Water Flow Rate	L/s		
8.	Cooling Water Entering Temperature	°C		
9.	Cooling Water Leaving Temperature	°C		
10.	Make-up Water Quantity	L/s		
11.	Constant Bleed Water Quantity	L/s		



**C. Cooling Tower Fan Check**

	<u>Parameters</u>	<u>Unit</u>	<u>Design Data</u>	<u>Test Results</u>
1.	Fan Type	-		
2.	Fan Diameter	m		
3.	Fan Volume	m <sup>3</sup> /s		
4.	Fan Power	kW		
5.	Fan Pressure	Pa		

**D. Cooling Tower Electrical Test**

	<u>Parameters</u>	<u>Unit</u>	<u>Design Data</u>	<u>Test Results</u>
1.	Supply Voltage	V		
2.	Motor Starting Current	A		
3.	Motor Running Current	A		
4.	Motor / Fan Speed	rpm		
5.	Phase – Phase Motor Insulation (RY/YB/BR)	MΩ		
6.	Phase – Earth Motor Insulation (RY/YB/BR)	MΩ		
7.	Motor Starter Type	-		

### Recommended List of Personal Protective Equipment

Job	Potential Hazard	Respirator and Clothing
Testing and commissioning	Aerosol	Half face piece, capable of filtering smaller than 5µm particulates, ordinary work clothing
Inspection	Aerosol	Half face piece, capable of filtering smaller than 5µm particulates, ordinary work clothing
Water Sampling	Aerosol	Half face piece, capable of filtering smaller than 5µm particulates, ordinary work clothing
High pressure spraying	Aerosol	Respirator as above, waterproof overalls, gloves, boots, goggles or face shield
Chemical treatment with sodium hypo-chlorite solution in ventilated space	Spray mist and very low concentration chlorine	Half face piece, acid gas and particulate respirator, goggles or face shield, overalls, gloves, and boots
As above, confined space	Unknown chlorine concentration, high mist, possible lack of oxygen	To comply with the requirement under The Factories and Industrial Undertakings (Confined Spaces) Regulation

**Energy Efficiency**  **EMSD**

**Energy Efficiency Office**  
**Electrical and Mechanical Services Department**

3 Kai Shing Street, Kowloon Bay, Hong Kong

**機電工程署 能源效益事務處**

香港九龍灣啓成街三號

Tel 電話: (852) 2808 3465 Fax 傳真: (852) 2890 6081

Website 網址: [www.emsd.gov.hk](http://www.emsd.gov.hk)

Email 電郵: [info@emsd.gov.hk](mailto:info@emsd.gov.hk)