

# 氣體產品@ESG



2023年氣體安全簡介會 (2023年10月11日)

吳惠華工程師

香港中華煤氣有限公司

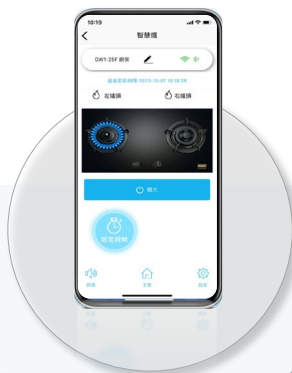
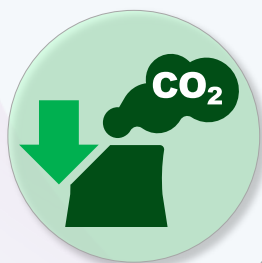



# 什麼是ESG?



# 環境

Environment



# 社會

Social



# 管治

Governance

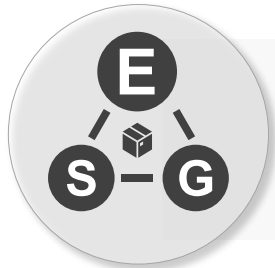

# 氣體產品與ESG



節能

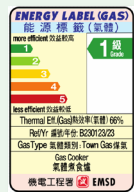

節水



減廢



智慧



樂齡  
科技



智能



品質



監管





# 節能減排

## 節能

### 強制性能源效益標籤計劃

第四階段

2023年9月1日生效

2024年12月1日全面實施

ENERGY LABEL (GAS) 能源標籤(氣體)	
more efficient 效益較高	
1	
2	
3	
4	
5	less efficient 效益較低
<b>1 級</b> Grade	
Thermal Eff.(Gas) 熱效率(氣體) 66.2% Ref/Yr 編號/年份: G230123/23 Gas Type: Town Gas 氣體類別: 煤氣 <b>Gas Cooker</b> <b>氣體煮食爐</b> 機電工程署 EMSD	

ENERGY LABEL (GAS) 能源標籤(氣體)	
more efficient 效益較高	
1	
2	
3	
4	
5	less efficient 效益較低
<b>1 級</b> Grade	
Thermal Efficiency(Gas)(%) 熱效率(氣體)(%) -at 100% load condition 滿載功率 92.3 -at 50% load condition 半載功率 88.2 Rated Heat Input (kW) 額定熱負荷 (千瓦) 25.3 Gas Instantaneous Water Heater 即熱式氣體熱水爐 Gas Type 氣體類別: Town Gas 煤氣 Brand 品牌: ABC 某某牌 Model 型號: HK1234 Reference Number / Year Information Provider 參考編號 / 年份: H230123 / 2023 XYZ 資料提供者: 某某某 機電工程署 EMSD	

即熱式  
氣體熱水爐

## 節水

### 熱水爐ECO模式

- 額定9升水輸出
- 相等於水務署水效益標籤計劃(沐浴花灑)的1級要求





# 轉廢為能

## 餘熱轉電

- 餘熱 → 電能
- 無需使用乾電池

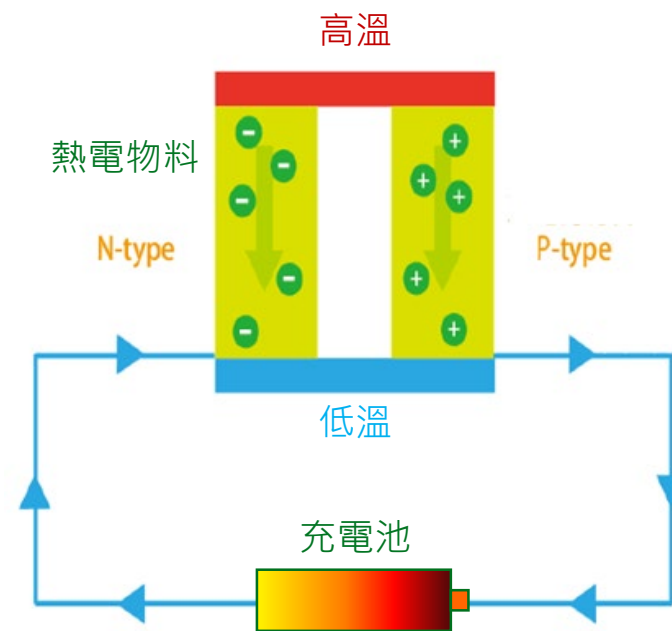
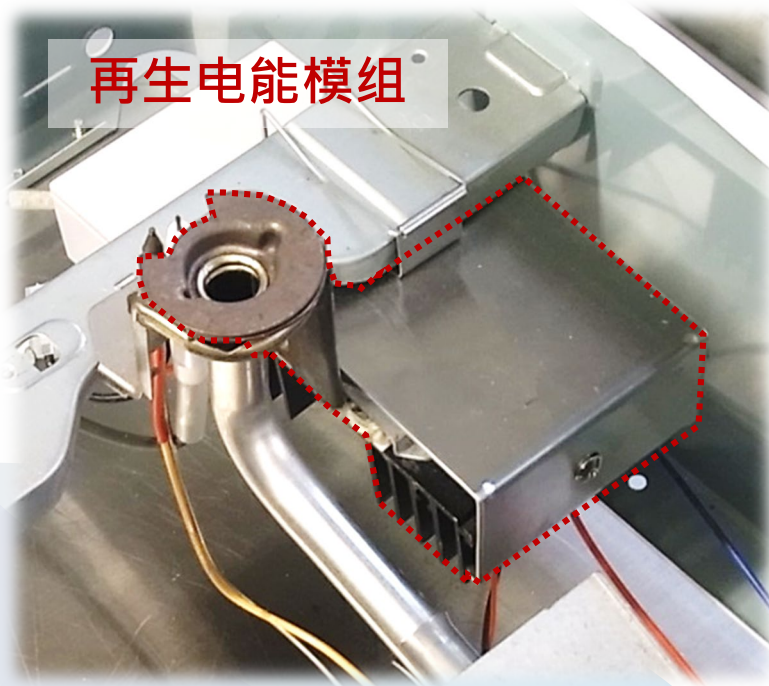





# 源頭減廢

## 🔋 減少使用乾電池

鋰電池包/USB適配器和仿電池

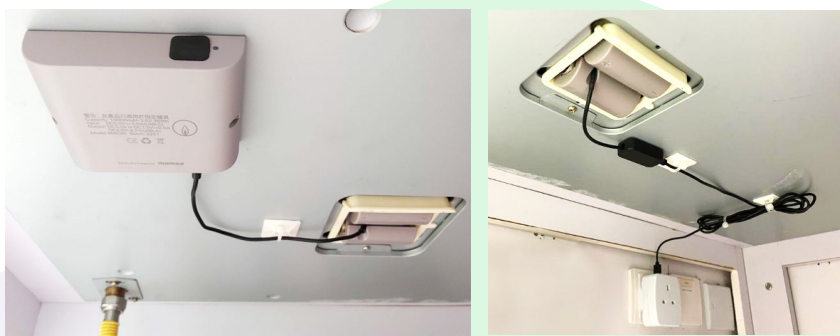

簡單、靈活、緊湊



## 🔋 水力發電和電容模組

取代「對衡式熱水器」的乾電池

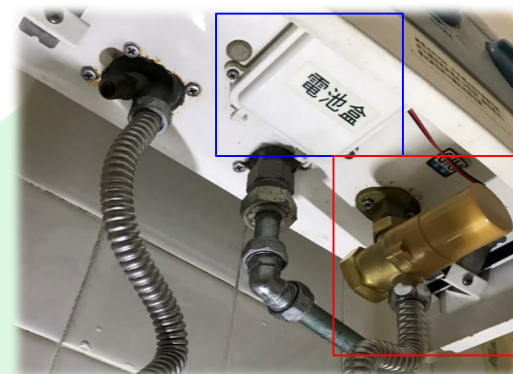

電容儲電，無需充電池

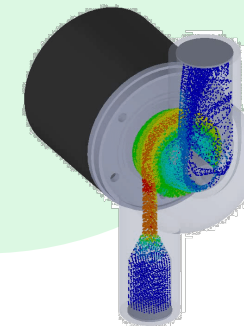
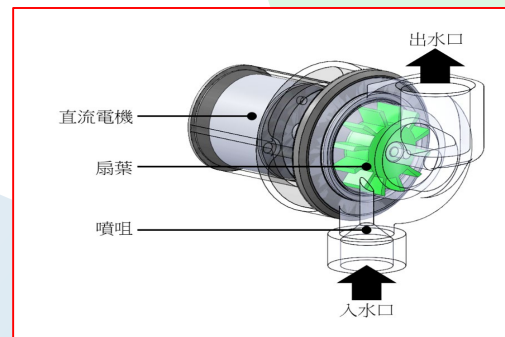



# 珍惜資源



- 手機遙控器
- 耗氣/耗水用量記錄
- 預約預熱循環水功能

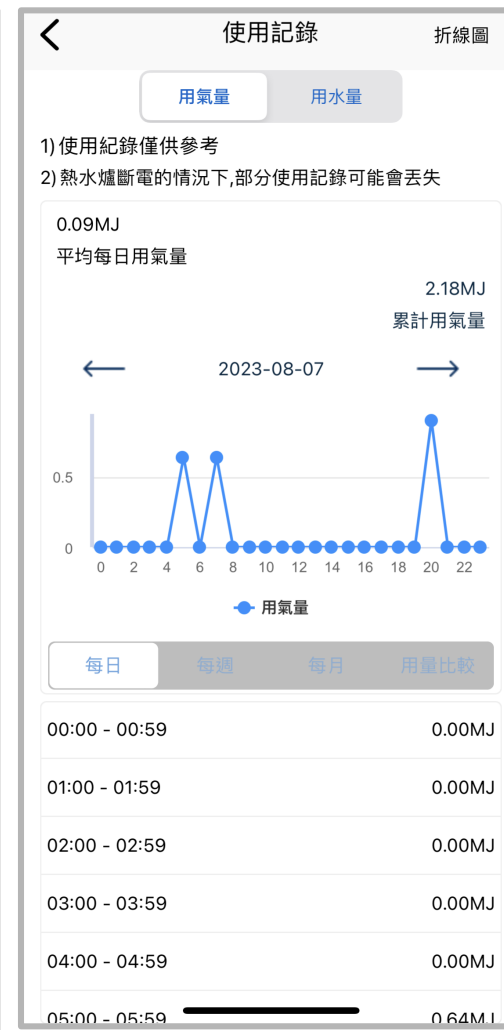

# 明火安心煮食



## 智能控制器

- 將傳統煮食爐升級至有智慧功能
- 毋須換爐，更經濟、環保



- 多人同時監察和遠程熄火
- 離家未熄火提醒
- 爐具使用中提醒
- 樂齡科技應用







# 安全和便利

## 智能傳感器功能



- 高溫過熱熄火
- 離鍋保護
- 智能烹調

## 時間掣功能

### 實體時間掣



### APP時間掣





# 關愛設計

## ♥ 放大/彩色文字 和 3D標籤

(與社福機構合作)



3D標籤指示燃燒器中心位置



# 愛心標籤

♥ 高溫改變紅色安全標籤

(與社福機構合作)

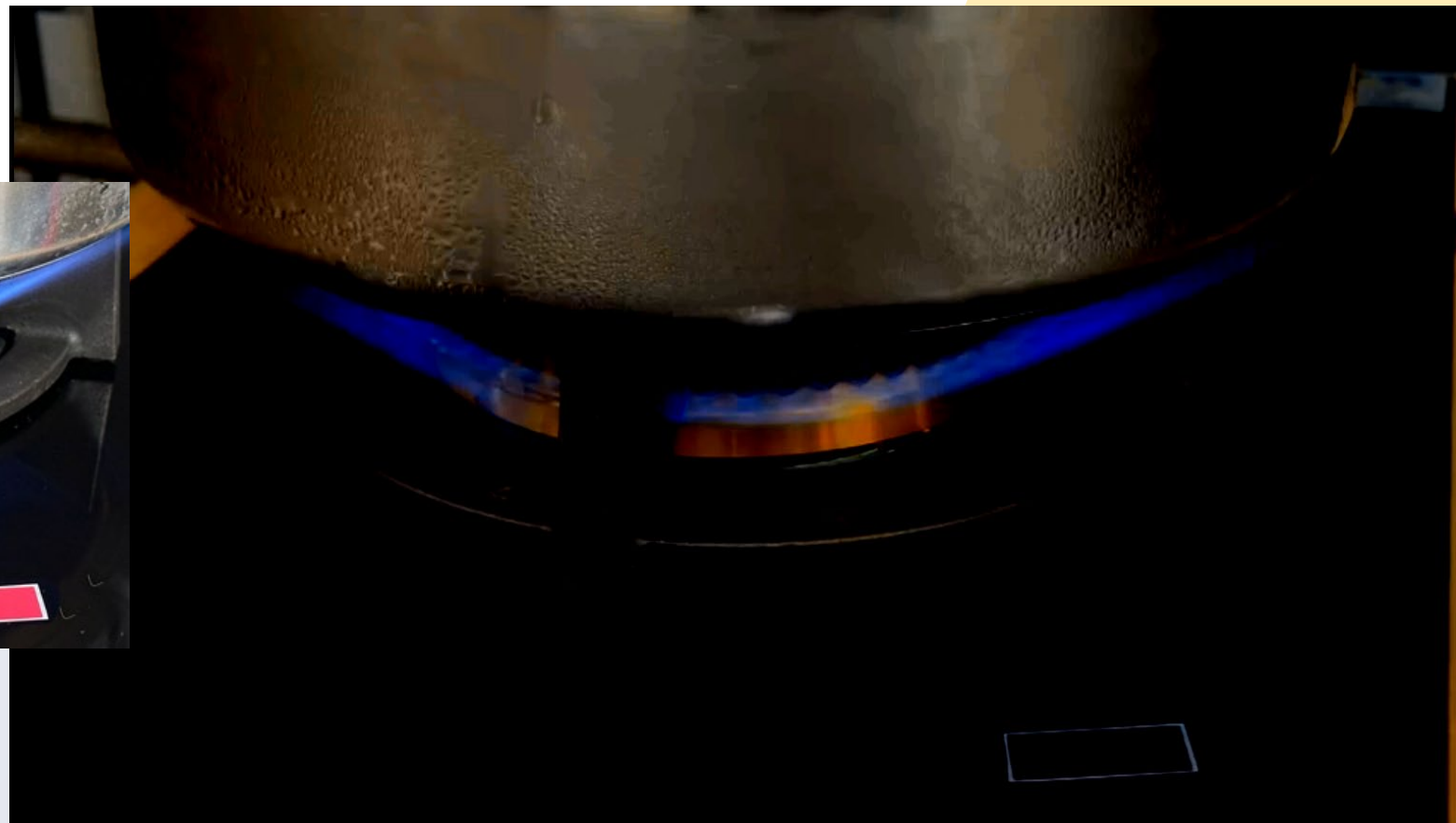
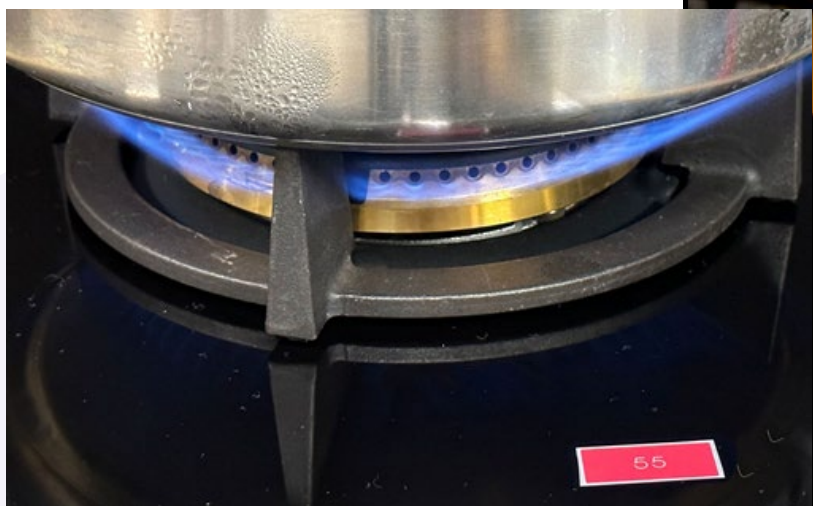



# 源頭守護

## 智「衛」家園

內置截氣閥門

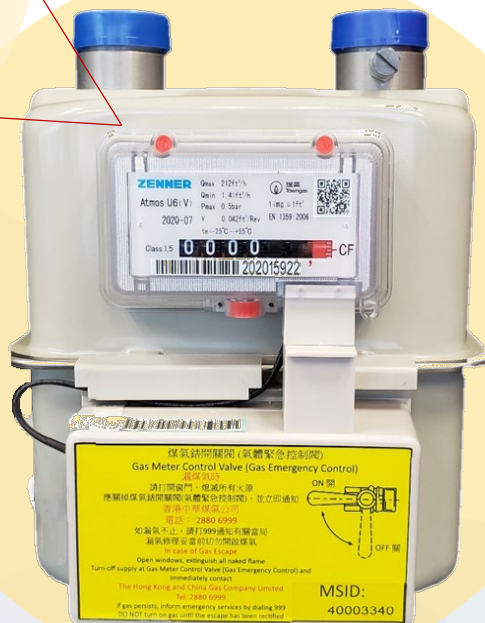

智安全煤氣錶

## 以燃氣流量判斷異常狀態

嚴重漏氣	輕微洩漏	逾期安檢
破壞氣喉自剎	疑似洩漏	喉管老化

自動關閥截氣, 並通知煤氣公司





# 智安全煤氣錶

## 統計資料

(截至2023年9月底)

- 2021年開始現場測試
- 全面實施：新安裝-2023年1月，更換-2023年5月

智安全煤氣錶		安裝數量
新安裝表數量		19,000
更換表數量		14,000
總計		33,000

智安全煤氣錶		數量
輕微洩漏	忘記熄火	65
	操作不當(2)/工藝不當(2)/老化導致(1)	5
嚴重漏氣	操作不當(2)/老化導致(0)	2
總計		72 (0.2%)

客戶將火調至最小，而不是將其熄火



例如操作不當拆了錶和管道



# 法規和品質

氣體安全的  
捍衛者



住宅式氣體用具批准

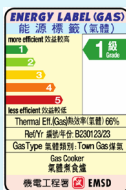

強制性  
能源效益標籤計劃

ENERGY SAVING  
FOR ALL



商品說明



法規  
監管



品質  
合規



嚴格的IQC計劃



供應商工廠檢查



年度產品審核



# 通訊技術及網絡安全

## 法規



## 電訊條例



## 國家標準



身份驗證



數據加密



隨機金鑰



超文字傳輸安全協議

## GB/T22239-2019 信息安全技術 网络安全等级保护基本要求

等級	等級定義	適用系統	公民、法人和其他組織的合法權益	社會秩序和公共利益	國家安全
第一級	信息系統受到破壞後，會對公民、法人和其他組織的合法權益造成損害，但不損害國家安全、社會秩序和公共利益	不重要系統	造成損害	不損害	不損害
第二級	信息系統受到破壞後，會對公民、法人和其他組織的合法權益產生嚴重損害，或者對社會秩序和公共利益造成損害，但不損害國家安全	一般重要系統	嚴重損害	造成損害	不損害
第三級	信息系統受到破壞後，會對社會秩序和公共利益造成嚴重損害，或者對國家安全造成損害	比較重要系統		嚴重損害	造成損害
第四級	信息系統受到破壞後，會對社會秩序和公共利益造成特別嚴重損害，或者對國家安全造成嚴重損害	非常重要系統		嚴重損害	嚴重損害
第五級	信息系統受到破壞後，會對國家安全造成特別嚴重損害	極度重要系統			嚴重損害

# 氣體產品@ESG



2023年氣體安全簡介會 (2023年10月11日)

- 謝謝 -

